

Datasheet

DMC Co.Ltd.

TSC-44/RSA-E

TO-02-057

The information contained in this document has been carefully researched and is, to the best of our knowledge, accurate. However, we assume no liability for any product failures or damages, immediate or consequential, resulting from the use of the information provided herein. Our products are not intended for use in systems in which failures of product could result in personal injury. All trademarks mentioned herein are property of their respective owners. All specifications are subject to change without notice.

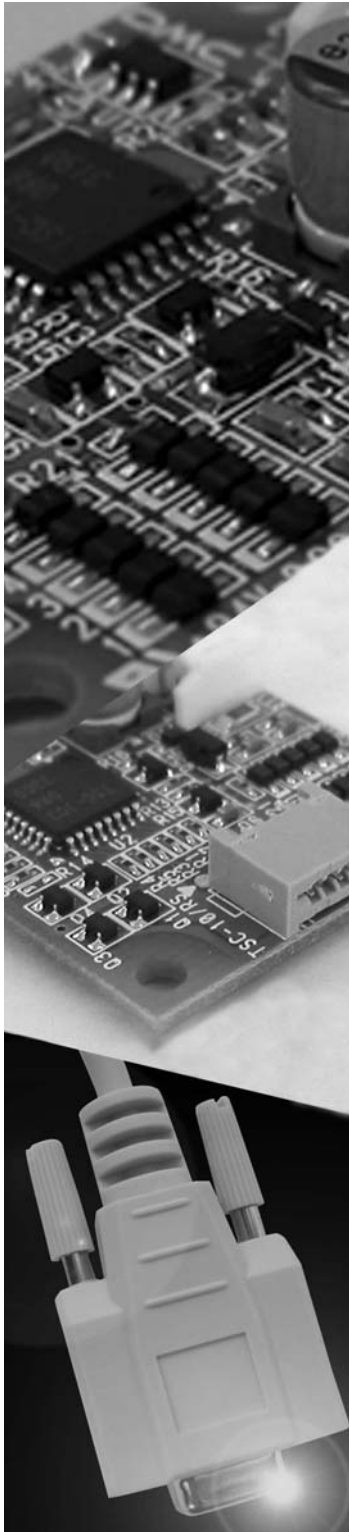

 **DMC Co., Ltd.**
Interface with Touch

Analog Resistive Touch Screen Controller TSC-44/RSA-E User's Guide

Table of Contents

1. Product Overview	2
1-1. Products Applicable	2
1-2. Overview	2
1-3. Peripheral Composition Overview.....	3
2. Specifications	4
3. Connector.....	5
3-1. Explanation of a connector terminal.....	5
3-2. The mounted connector	5
4. Packing Specification.....	6
4-1. Outline.....	6
4-2. Packing material	6
4-3. Outer case and lot label.....	6
4-4. Product name label	7
5. Changes & Improvements.....	8
5-1. Version History.....	8
6. Warranty	9
6-1. Warranty Period	9
6-2. Warranty Target	9
6-3. Warranty Exceptions.....	9
7. Precautions for Use.....	10
7-1. General Handling	10
7-2. Others	10

Dimensional Drawing

1. Product Overview

1-1. Products Applicable

This specification is applicable to TSC-44/RSA-E.

1-2. Overview

TSC-44/RSA-E are a touch screen controller board that performs an A/D conversion of an analog signal of a resistive touch screen, and transmits the coordinate data to the host in a 10-bit resolution serial correspondence at 9600bps. TSC-44/RSA-E can be used for various applications for its functions including the power saving mode, seven sampling speed settings (max. 150p/s *1), two external switch connections, and automatic calibration data loading with an external EEPROM.

§ TSC-44/RSA-E TSC-44/RSA-E dispenses a need to newly design the peripheral circuits, and can easily be used by connecting to the touch screen and the host. Using the driver software *2 enables the mouse emulation on various operation systems and dispenses the need to newly design the controller software.

The calibration data can be stored in the EEPROM and automatically read after power-on.

TSC-44/RSA-E is the product compatible with software of the TSC-10/RSA series.

*1: 150 transmissions of coordinate data per second.

*2: Please contact the local sales representatives for software availability.

TSC-44/RSA-E is a succeeding model of the boards of the TSC-10/RSA series.

TSC-44/RSA-E is lead-free and compliant with RoHS.

1-3. Peripheral Composition Overview

A resistive touch screen is operated by resistance sensitive system between two layers such as film or glass. Two pieces of transparent materials with conductive coating are placed in the same direction as two electrodes face each other. The touch screen is activated when these transparent conductive layers are pressed to contact each other with a finger or a pen. The one of these conductive layers functions as an X-coordinates electric circuits and the other as a Y-coordinates circuits. To measure the X-coordinates TSC-44/RSA-E supplies voltage, V_{cc} to the one of X-coordinates electrodes with GND to the other. When the touch screen is pressed under this environment the voltage of the X-coordinates resistance is detected by the Y-coordinates electrode (A_{in}) at the input point ($x1$), where the X-Y coordinate resistance layers make contact. The detected voltage in supply side is higher than the GND side, which means ' A_{in} '= V_{cc} at the point 'E' and ' A_{in} '= 0 (*1) at the point 'A'. TSC-44/RSA-E calculates coordinates data starting from A/D conversion of the ' A_{in} ' voltage. The Y-coordinates is measured in the same way. By repeating this process alternately, coordinate value at the input point is determined.

(*1) Excluding the loss in the controller circuits and touch screen. Actual detected voltage should be lower than ' $V_{cc} - GND$ ' because of loss happened in the circuitry.

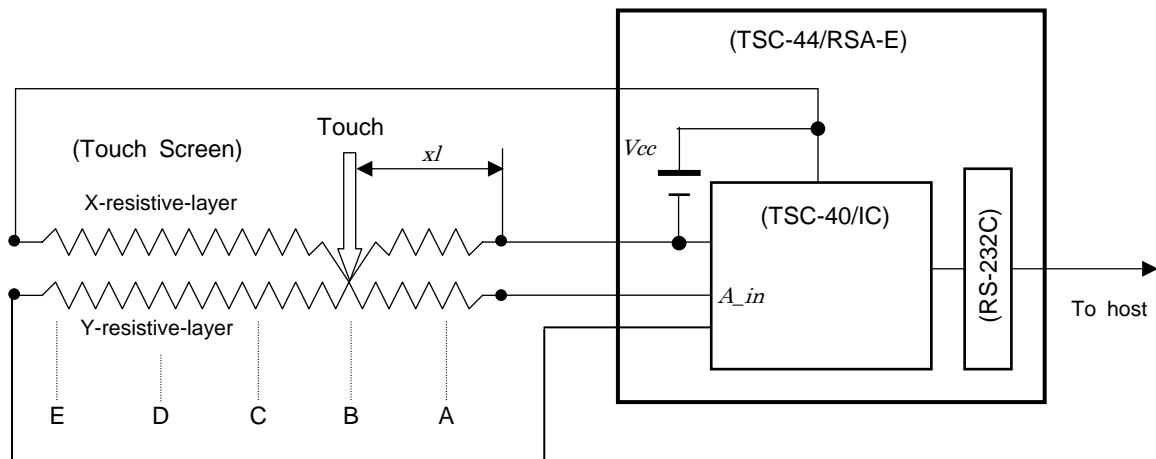
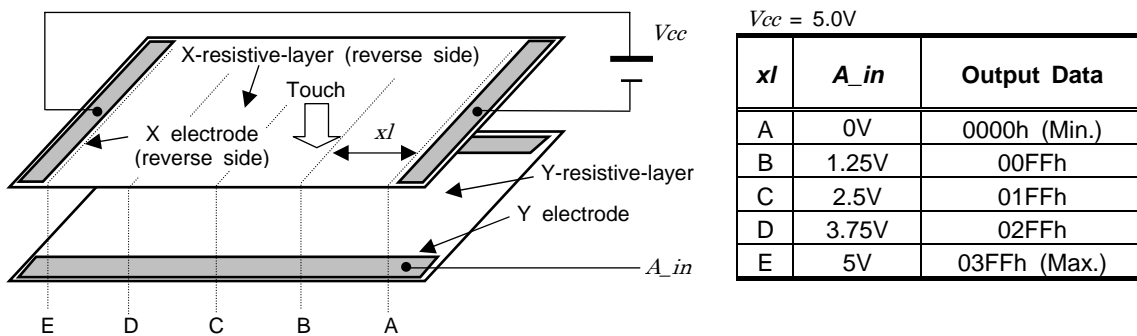

2. Specifications

General Specifications

Item		Rating	Remarks
Operating Temp.		-20°C to +75°C (No dew condensation)	
Storing Temp.		-20°C to +85°C (No dew condensation)	
Supply Voltage		DC 4.1V to 5.5V	
Consumption Current		15mA	Vin=5.0V, 50p/s, touch screen is activated.
Correspondence	Format	Asynchronous Serial	Fixed value
	Transfer Rate	9600bps	
	Data Format	8bit	
	Stop Bit	1bit	
	Parity	None	
Frequency		6MHz	6MHz fixed
Dimension		30 x 40 mm	
Max height of components		8mm	The backside of a board.
		(2mm)	

Performance Specifications

Description	Rating	Note
Coordinate Output Rate (point/sec)	(1) point mode (2) 30p/s (3) 50p/s (4) 80p/s (5) 100p/s (6) 130p/s (7) 150p/s	Default: 50pps with DMC original driver software.
Coordinate Resolution	10bit (1024 x 1024)	The value will be lower in the active area of the touch screen
Linearity Error	±3 LSB	
Input Response Time	10ms (TYP)	

3. Connector

3-1. Explanation of a connector terminal

CN	Terminal	Name	Function
CN1	1	XL	Touch screen Input XL (Open if CN2 is used)
	2	YU	Touch screen Input YU (Open if CN2 is used)
	3	XR	Touch screen Input XR (Open if CN2 is used)
	4	YD	Touch screen Input YD (Open if CN2 is used)
CN3*1	1	Dout	RS-232C Data Output
	2	Din	RS-232C Data Input
	3	GND	RS-232C GND
	4	Vin	RS-232C Power (Open if power is supplied from CN5)
	5	Vin	RS-232C Power (Open if power is supplied from CN5)
CN5	1	Vin	Power (+5V) (Open if power is supplied from CN3 or CN4)
	2	GND	GND (Open if power is supplied from CN3 or CN4)

*1: Please note the difference from the number of CN3 and the pin numbering of the connector manufacturer. The number described in CN3 is a terminal number described in "Dimensional Drawing".

3-2. The mounted connector

CN	P/N	Manufacturer
CN1	00-8370-049-000-800+	KYOCERA ELCO CORPORATION
CN3	S5B-PH-K-S	J.S.T. Mfg Co., Ltd
CN5	S2B-PH-K-S	J.S.T. Mfg Co., Ltd

4. Packing Specification

4-1. Outline

TSC-44/RSA-E is wrapped up in the air packing of the prevention of static protection type and puts it in a packing box.

4-2. Packing material

Outer case: 75 x 55 x 15 mm, clay coated newsback board

Cushioning: 120 x 70 mm, air packing, static protection

4-3. Outer case and lot label

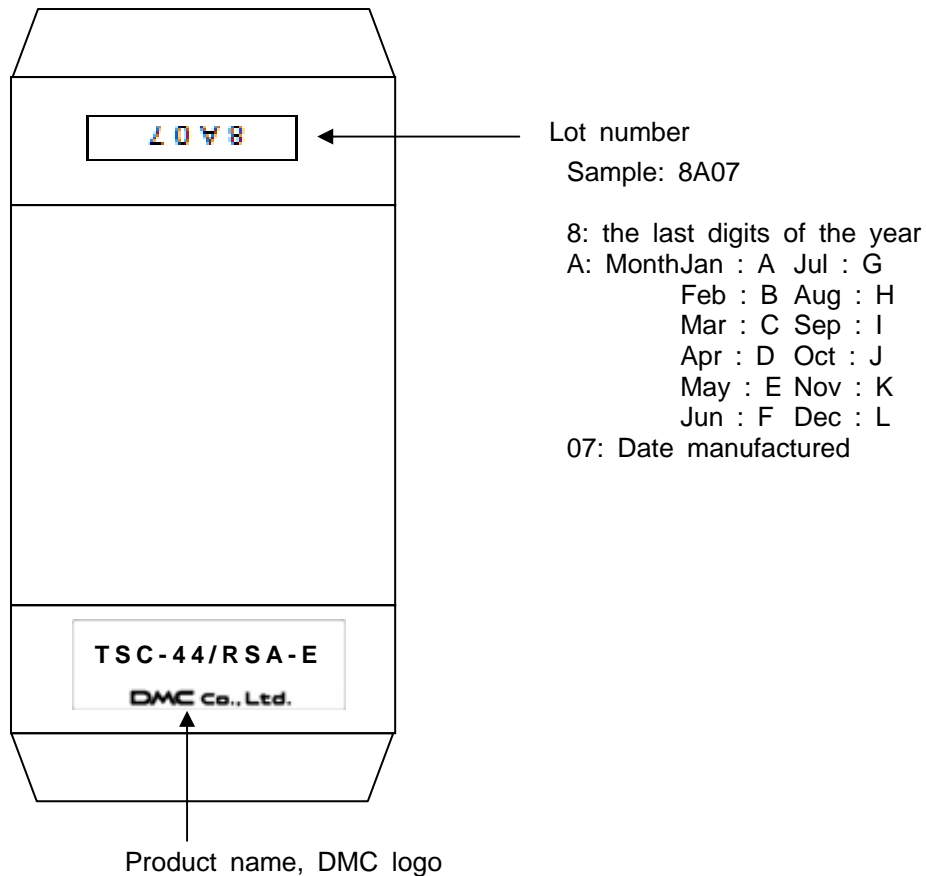

4-4. Product name label

Backside of board

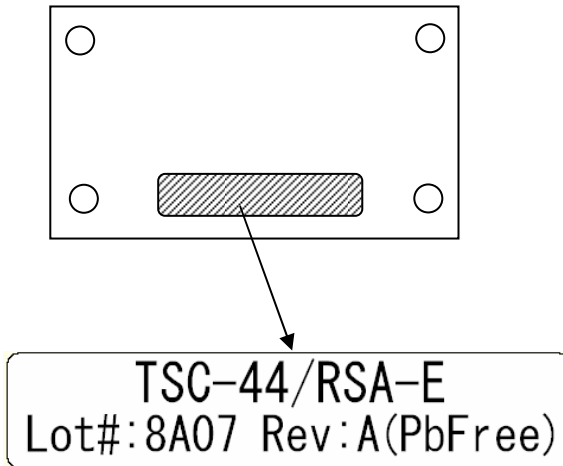

TSC-44/RSA-E: Product name

Lot#: 8A07

8: the last digits of the year

A: Month Jan : A Jul : G

Feb : B Aug : H

Mar : C Sep : I

Apr : D Oct : J

May : E Nov : K

Jun : F Dec : L

07: Date manufactured

Rev: Revision information

(PbFree): lead free

5. Changes & Improvements

5-1. Version History

§ TSC-44/RSA-E

Ver0.1 (January 15, 2008)

Draft release.

Ver 1.0 (March 13, 2008)

First release

(Change from ver0.1)

2. Specifications Consumption Current and Input Response Time were added.

Dimensional Drawing Revision 1 for first release

Ver 1.1 (August 18, 2009)

3-1. Explanation of a connector terminal Notes were added.

6. Warranty

6-1. Warranty Period

- § The warranty period is limited to 1 year from the date of shipping. The warranty for the initial deflection such as appearance deflection is limited to 1 month.
- § Any defected parts under proper use will be examined by the supplier and replaced by the new parts if the deflection is considered to be caused by the supplier.
- § The replacement is subject to be included in the next lot.

6-2. Warranty Target

- § The warranty only covers the product itself and does not cover any damage to others caused by using this product. Onsite repair or replacement is not supported.
- § We will do our best for delivery problem and product defections, but the warranty for the production line is not covered.

6-3. Warranty Exceptions

Following conditions are not covered with the warranty and subject to charge.

- § Any malfunctions and damages during transportation and transfer by the user.
- § Any malfunctions and damages caused by a natural disaster or a fire.
- § Any malfunctions and damages caused by static electricity
- § Any malfunctions and damages caused by the failure of the associated equipment.
- § If the product is remodeled, disassembled or repaired by the user.
- § If the product is glued onto the equipment and uninstalled.
- § Any malfunctions and damages caused by an improper usage and handling against the specifications and notes.

7. Precautions for Use

7-1. General Handling

- § Keep the product away from any conductive objects while in use.
- § Do not touch the conductive part of the product to avoid being damaged by the electrostatic discharge. Follow the proper procedure for handling.
- § Keep the product in the proper storing environment and avoid any load to the product.
- § Do not use or store the product in the severe condition like following:
 - Wet environment or a condition where the product is likely to get wet.
 - Where dew condensation is likely to occur.
 - Near solvent or acid.
- § Do not take apart or alter the product.

7-2. Others

- § The contents of this document are subject to change without notice.
- § The manufacturer or sales representatives will not be liable for any damages or loss arising from use of this product.
- § This product is intended for use in standard applications (computers, office automation, and other office equipment, industrial, communications, and measurement equipment, personal and household devices, etc.) Please avoid using this product for special applications where failure or abnormal operation may directly affect human lives, or cause physical injury or property damage, or where extremely high levels of reliability are required (such as aerospace systems, vehicle operating control, atomic energy controls, medical devices for life support, etc.).
- § Any semiconductor devices have inherently a certain rate of failure. The user must protect against injury, damage, or loss from such failures by incorporating safety design measures into the user's facility and equipment.

TSC-44/RSA-E User's Guide
Rev. 1.1, August 18, 2009
©2009 DMC Co., Ltd.

This document can be freely distributed, but any alternation to this document is prohibited.

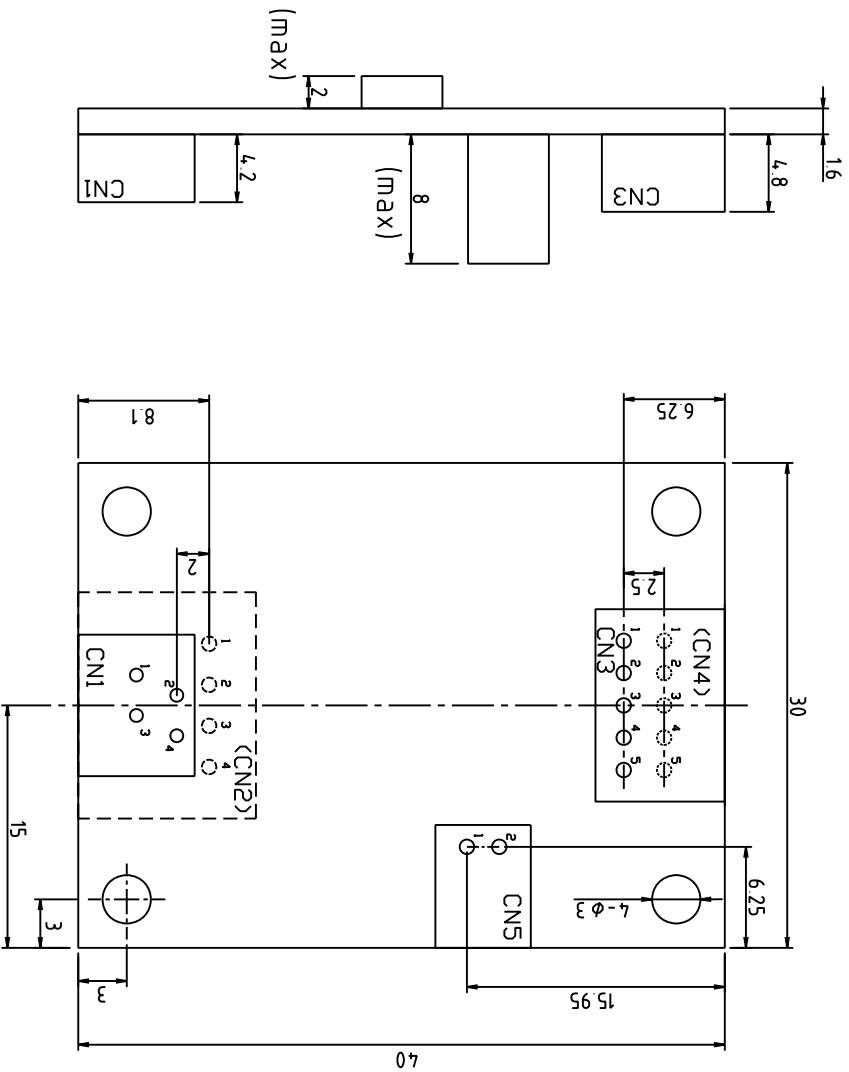

Unit = mm

Date	P/N
February 22, 2008	TSC-44/RSA-E
Name	
Dimensional Drawing	Rev.1
DMC Co., Ltd.	

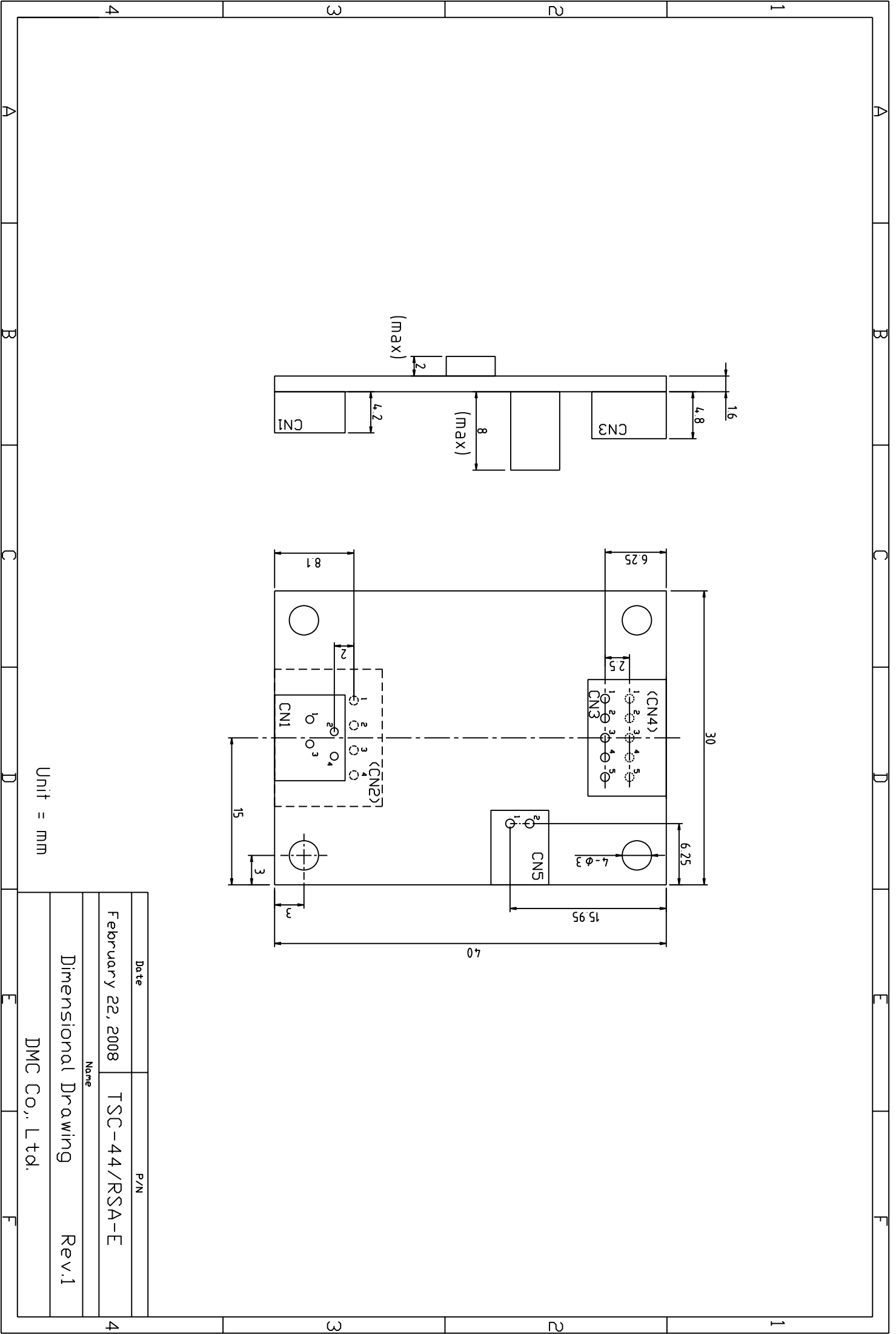

Our company network supports you worldwide with offices in Germany, Great Britain, Turkey and the USA.
For more information please contact:



DATA DISPLAY GROUP

A **FORTEC** GROUP MEMBER

Distec GmbH

Augsburger Str. 2b
82110 Germering
Germany

Phone: +49 (0)89 / 89 43 63-0
Fax: +49 (0)89 / 89 43 63-131
E-Mail: info@datadisplay-group.de
Internet: www.datadisplay-group.de

Display Technology Ltd.

5 The Oaks Business Village
Revenge Road, Lordswood
Chatham, Kent, ME5 8LF
United Kingdom
Phone: +44 (0)1634 / 67 27 55
Fax: +44 (0)1634 / 67 27 54
E-Mail: info@displaytechnology.co.uk
Internet: www.datadisplay-group.com

FORTEC Elektronik AG

Lechwiesenstr. 9
86899 Landsberg am Lech
Germany

Phone: +49 (0)8191 / 911 72-0
Fax: +49 (0)8191 / 217 70
E-Mail: sales@fortecag.de
Internet: www.fortecag.de

Apollo Display Technologies, Corp.

87 Raynor Avenue,
Unit 1 Ronkonkoma,
NY 11779
United States of America
Phone: +1 631 / 580-43 60
Fax: +1 631 / 580-43 70
E-Mail: info@apolloDisplays.com
Internet: www.apolloDisplays.com

Sales Partner:

DATA DISPLAY BİLİŞİM TEKNOLOJİLERİ İÇ VE DIŞ TİCARET LİMİTED ŞİRKETİ

Barbaros Mh. Ak Zambak Sk. A Blok D:143
34376 Ataşehir / Istanbul
Turkey

Phone: +90 (0)216 / 688 04 68
Fax: +90 (0)216 / 688 04 69
E-Mail: info@data-display.com.tr
Internet: www.data-display.com.tr