

OUR GLOBAL
COMPETENCE
CENTRES

 APOLLO DISPLAY
TECHNOLOGIES



 DISTEC



 DISPLAY
TECHNOLOGY



Datasheet

Distec

Prisma-III E

All-In-One Compact DVI (HDMI/HDCP)/RGB/Video Converter Board

VGA - WUXGA

PR-01-322

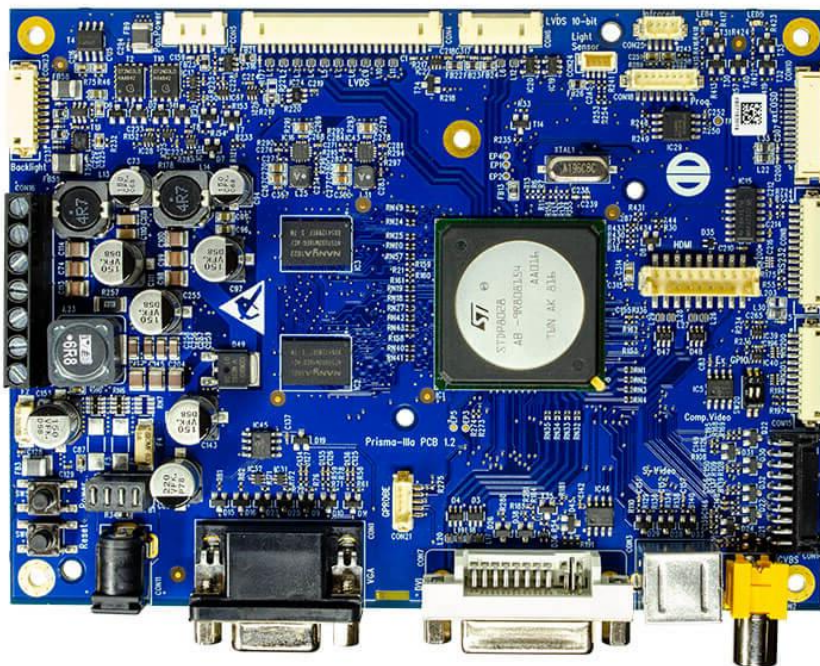

Design EN55022 and EN61000-6-2 oriented

Version 1.8

20.01.2020

The information contained in this document has been carefully researched and is, to the best of our knowledge, accurate. However, we assume no liability for any product failures or damages, immediate or consequential, resulting from the use of the information provided herein. Our products are not intended for use in systems in which failures of product could result in personal injury. All trademarks mentioned herein are property of their respective owners. All specifications are subject to change without notice.

Table of Contents

1	Revision History	5
2	Overview	6
3	Warnings	6
4	General Features	6
5	Hardware Features	7
6	OSD Menu and User Controls	9
6.1	OSD Control Through External Keypad	9
6.1.14	Button OSD Keypad ZU-02-398	9
6.1.26	Button OSD Keypad ZU-02-315	10
6.2	OSD Control through IR Remote Control	11
6.3	Input Selection	11
7	On-Screen-Menu (OSM)	12
7.1	Sub-Menu "Image Settings"	12
7.2	Sub-Menu "Display Settings"	16
7.3	Sub-Menu "Position Settings"	19
7.4	Sub-Menu "OSD Settings"	22
7.5	Sub-Menu "Setup"	23
8	Supported Input Modes	24
8.1	S-Video, CVBS, RGB+CS	24
8.2	Component	24
8.3	VGA	25
8.4	DVI/HDMI	25
9	Absolute Maximum Ratings	26
9.1	Thermal Derating Characteristics	26
10	Electrical Specification	27
10.1	Maximum allowed Power Consumption for TFT Panels	27
10.2	Maximum allowed Power Consumption for Backlight Inverter (V_{BKL})	28
11	Mechanical Specification	29
12	Connectors and Switches	34
12.1	Overview	35

12.2 Input Connectors.....	35
12.2.1 CON1: RGB – ANALOG INPUT CONNECTOR	35
12.2.2 CON2: C-VIDEO INPUT CONNECTOR	36
12.2.3 CON3: S-VIDEO INPUT CONNECTOR	36
12.2.4 CON7: DVI CONNECTOR	36
12.2.5 CON8: SERIAL COMMUNICATION CONNECTOR	37
12.2.6 CON9: TMDS (HDMI/DVI) INPUT CONNECTOR.....	38
12.2.7 CON10: OSD CONTROL PANEL CONNECTOR.....	39
12.2.8 CON11: POWER SUPPLY CONNECTOR.....	39
12.2.9 CON14: COMPONENT VIDEO INPUT CONNECTOR.....	40
12.2.10 CON15: GPIO	40
12.2.11 CON16: POWER SUPPLY CONNECTOR.....	41
12.2.12 CON24: LIGHT AND TEMPERATURE SENSOR CONNECTOR.....	41
12.2.13 CON25: IR REMOTE CONTROL RECEIVER CONNECTOR	42
12.3 Output Connectors.....	42
12.3.1 CON4: LVDS CONNECTOR.....	42
12.3.2 CON5: PANEL EXTRA POWER CONNECTOR.....	43
12.3.3 CON6: LVDS 10-BIT CONNECTOR	43
12.3.4 CON23: BACKLIGHT SUPPLY CONNECTOR	43
12.4 Switches.....	44
13 Supported Panels and Backlights (Inverter/Converter)	45
14 Appendix: PSU low-power-control timings (CON16 pin 5&6).....	46
15 Hardware Information	47

1 Revision History

Date	Rev.No.	Description	Page
13.04.2017	1.0	Initial version	All
09.05.2017	1.1	Added CON16 Pin1 definition	32
11.05.2017	1.2	Removed chapter News and Updates	43
19.05.2017	1.3	Changed DDC2B to DDC/CI	4
		Added temperature sensor	39
		Changed Chapter 12 to Supported Panels and Backlights	43
11.08.2017	1.4	Removed 3,3V Backlight Voltage Support	43
		Changed Ordering to Hardware Information 14	45
		Last page updated	46
06.02.2018	1.5	Clarified PiP tiling limitations	17
30.07.2018	1.6	Added missing picture of HDMI/DVI cables	37
21.10.2019	1.7	Added new remote control RC-10-007	9
20.01.2020	1.8	New Template, added new product picture	all

2 Overview

Prisma-IIIIE is a graphics processing board, providing high quality images for LCD TFT panels. The board supports TFT panels up to WUXGA and can be used in a variety of systems. It is developed by Distec GmbH who is able to adapt almost every TFT panel.

3 Warnings

Although the Prisma-IIIIE is using protection circuits for most of its interfaces, it is strongly recommended to prevent the attached devices from drawing too much current from the Prisma-IIIIE.

4 General Features

- Zoom and shrink scaling
- Frame rate conversion
- Faroudja Truelife video enhancer and RealColor color enhancer
- Supports VESA DDC/CI and a subset of VESA DPMS standards
- PWM or voltage controlled backlight intensity
- Four or six button OSD - keypad interface and on-screen menus allow adjustments to the system
- True High Definition 1080p on DVI connector, supporting HDMI 1.3 and 1.4
- Optional second TMDS video input (HDMI/DVI)
- Analog RGB/VGA input capture up to 205MHz
- Video input: CVBS, S-Video, Component Video (YPbPr), RGB+CS
- ROSD (RS232 serial remote control protocol)
- Fully Customizable through the configuration software "MarsRover"
- Extended Temperature Range

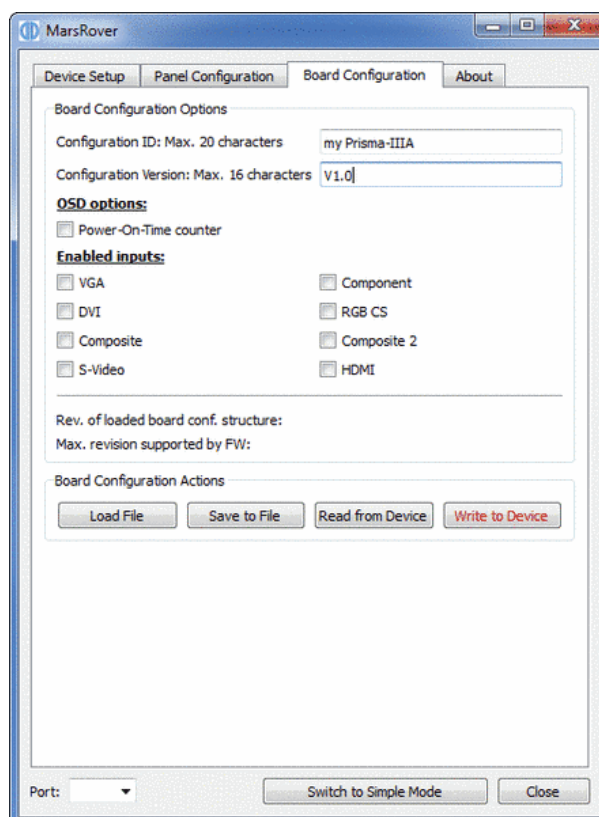

5 Hardware Features

High-Quality Advanced Scaling

- Zoom and shrink ability
- Independent horizontal / vertical zoom and shrink
- Moiré cancellation
- Motion Adaptive De-interlacing
- Motion Adaptive Noise Reduction
- Low Angle Diagonal Interpolation

Analog RGB Input

- Supports up to 1792x1344@60Hz or 1920x1260@60Hz or 1600x1200@75Hz standard modes
- Supports up to 1920x1440@60Hz or 2128x1200@ 60Hz with reduced blanking
- Captures up to 205MHz

DVI/HDMI Receiver

- Single Link TMDS Rx for up to 12-bit 1080p (16-bit supported but dithered)
- Direct connect to all DVI/HDMI 1.3 and 1.4 compliant TMDS transmitters

Video Inputs

- Supports Composite video, S-Video and Component Video
- Up to 1080p support on Component Video
- 3D Adaptive Comb Filter for Luma-Chroma separation of CVBS input

LVDS Interface

- Fully programmable LVDS mappings for compliance with all LVDS protocols

LCD Overdrive

- Reduces video smearing artifacts of rapid luminance transition scenes caused by slow LCD panel response

RealColor™ Technology

- Color filtering in YUV domain
- Digital brightness, contrast, hue and saturation control for analog, digital and video inputs

Auto-Configuration / Auto-Detection

- Phase and image positioning
- Input format detection

Frame Store

- Frame rate conversion
- Shrink scaling

On Screen Display

- Horizontal and vertical stretch of OSD images
- Transparency and blending
- 16 True-Color bitmap tiles with 1, 2, 4, and 8-bit per pixel

Output Format

- Single/double channel up to WUXGA 60Hz output for LVDS panels
- Support for 10, 8 or 6-bit panels (with high-quality dithering)

Operation Modes

- Frame rate conversion and scaling of images
- Bypass mode with no filtering and/or frame buffering
- 1:1 centering
- Frame Sync, Free Run and Auto Sync display synchronization modes

Power saving functionality

Prisma-IIIIE supports Power Supply Unit remote control. This allows Prisma-IIIIE firmware to shut down Display and / or inverter power supply if Prisma-IIIIE goes in standby mode. During normal operation/input search/input-not-supported/sleep states, the external power supply will be enabled. During power-off mode, the external supply will be disabled.

The following features are supported (**without Board modifications**):

- Short=PowerOFF, Open=PowerON
 - Connect PSU Remote Control: GND: CON16 Pin2, PSU_RC: CON16 Pin 6
- Short=PowerON, Open=PowerOFF
 - Connect PSU Remote Control: GND: CON16 Pin2, PSU_RC: CON16 Pin 5
- 0V=PowerON, 5V=PowerOFF
 - connection between CON16 Pin4 and CON16 Pin1 required
 - only possible with 5V standby power source
 - Connect PSU Remote Control: GND: CON16 Pin2, PSU_RC: CON16 Pin 5
- 5V=PowerON, 0V=PowerOFF
 - connection between CON16 Pin4 and CON16 Pin1 required
 - only possible with 5V standby power source
 - Connect PSU Remote Control: GND: CON16 Pin2, PSU_RC: CON16 Pin 6
- 0V=PowerON, 12V=PowerOFF
 - connection between CON16 Pin3 and CON16 Pin4 required
 - Connect PSU Remote Control: GND: CON16 Pin2, PSU_RC: CON16 Pin 5
 - only supported if Prisma-IIIIE is powered with 12V DC
- 12V=PowerON, 0V PowerOFF
 - connection between CON16 Pin3 and CON16 Pin4 required
 - Connect PSU Remote Control: GND: CON16 Pin2, PSU_RC: CON16 Pin 6
 - only supported if Prisma-IIIIE is powered with 12V DC

See Appendix A for timing details.

6 OSD Menu and User Controls

The OSD allows selection of input source and fine tuning of various functional parameters like brightness, contrast etc. These parameters can be adjusted via an external interface.

6.1 OSD Control Through External Keypad

An OSD keypad can be used to control the OSD. There is a 4-Button and 6-Button OSD keypad available, it can be connected to CON10 of Prisma-III E via cable **ZU-05-032**.

It depends on the factory settings of the firmware which keypad is active. The 4/6-Button keypad can be selected in the OSD submenu: OSD Settings -> Keypad Layout (see sec. 7.4).

6.1.1 4-Button OSD Keypad ZU-02-398

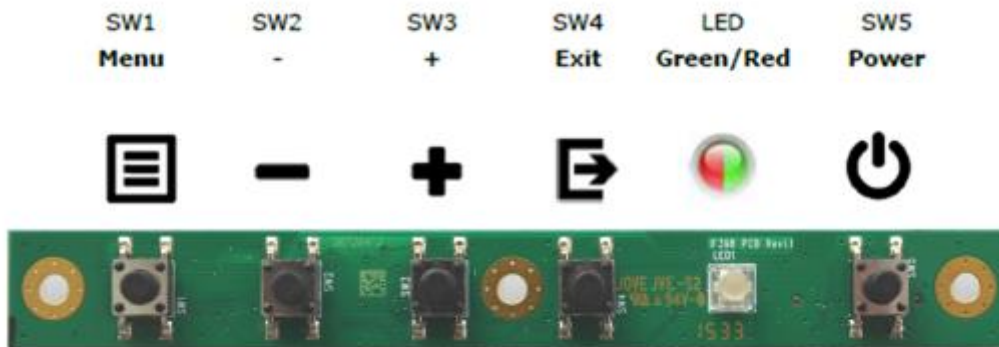

The following tables give you an overview about the functionality.

	Menu	-	+	Exit	LED	Power
General					See below	Power ON/OFF
OSD closed	Open OSD	PIP Input Select*	Hotkey Brightness	Input Select		
OSD open	Select	Down/Left/-	Up/Right/+	Exit/Back		

* Only available if PIP is enabled, see sec. 7.2.

LED Status:

- Green: Signal Found
- Green flashing: Searching Signal
- Red : Power Safe
- Red flashing: Blank or corrupted panel config data. Please contact Data Display support.
- LED OFF: Power OFF

6.1.2 6- Button OSD Keypad ZU-02-315

For users that wish to use a 6-button OSD, a keypad with 6 OSD control buttons is available.



6-BUTTON
EXTERNAL
KEYPAD

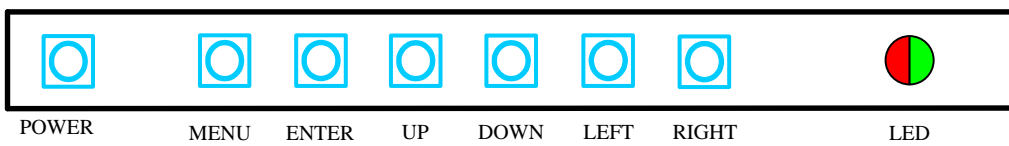

The following tables give you an overview about the functionality.

	Power	Menu	Enter	Up	Down	Left	Right	LED
General	Power ON/OFF							See below
OSD closed		Open OSD	n/a	Input Select	PIP Input Select*	Decrease Brightness	Increase Brightness	
OSD open		Exit/Back	Select	Up/+	Down/-	Left/-	Right/+	

* Only available if PIP is enabled, see sec. 7.2.

LED Status:

- Green: Signal Found
- Green flashing: Searching Signal
- Red : Power Safe
- Red flashing: Blank or corrupted panel config data. Please contact Data Display support.
- LED OFF: Power OFF

6.2 OSD Control through IR Remote Control

Alternative to the external keypads, the Prisma-III E can also be controlled through a remote control device. In order to communicate through IR, an IR-receiver **ZU-02-406** can be attached to connector CON25 of Prisma-III E via cable **KA-30-467**. With this receiver you can control the Prisma-III E with the IR Remote Control **RC-10-007** (see picture below).

Position	Code	Function
1	0x01	Power
2	0x0D	Key Up
3	0x11	Key Down
4	0x0E	Key Left / decrease Brightness
5	0x10	Key Right / increase Brightness
6	0x0F	Key Enter
7	0x27	Menu
8	0x13	Exit
9	0x05	Mute
10	0x04	Volume +
11	0x03	Volume -

RC-10-007 Button Position



RC-10-007 Picture



6.3 Input Selection

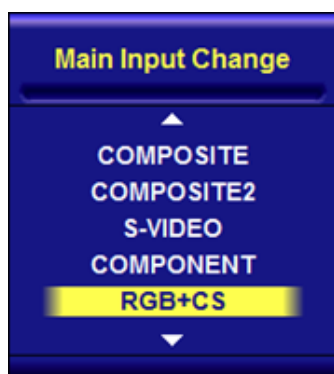

When the OSD is closed press SW4 on your keypad (EXIT key on 4-button keypad, UP key on 6-button keypad) or button “M” on your IR remote control. This opens the dialog shown on the left where you can manually switch to a specific input port. Note that only ports which are enabled in the FW and by the MarsRover configuration software (see sec. 4) can be selected in this dialog.

If you have PiP enabled (see sec. 7.2) then you can in the same way change the PiP input port: When the OSD is closed press SW2 (“-“ key) on your 4-button keypad or SW5 (DOWN key) on your 6-button keypad or button “P” on your IR remote control. This opens a dialog similar to the one on the left.

7 On-Screen-Menu (OSM)

7.1 Sub-Menu “Image Settings“

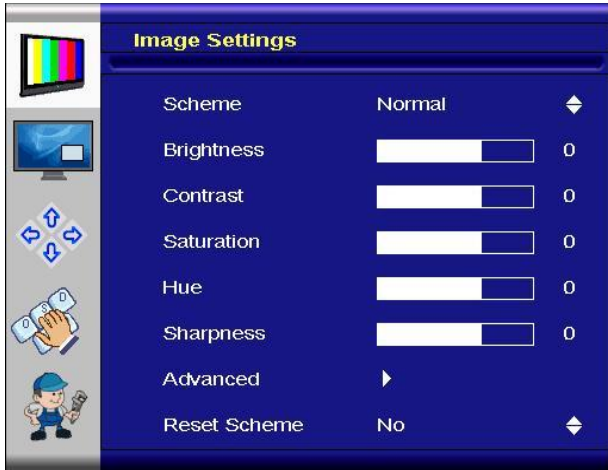

Figure 7.1.a “Image Settings” menu for S-Video, CVBS, YPbPr, RGB+CS and video mode of DVI/HDMI.

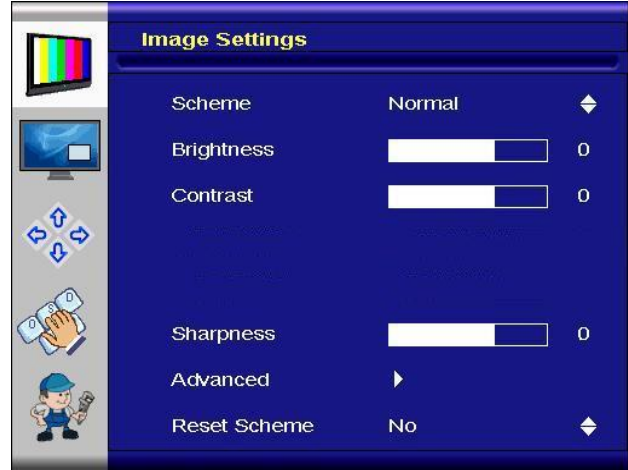

Figure 7.1.b “Image Settings” Menu for VGA and graphics mode of DVI/HDMI.

- Scheme:** Switches between normal/sport/game/cinema/vivid preset values. Each scheme has particular brightness, contrast, etc. values.
- Brightness:** Brightness of the image can be controlled using this function, with left and right buttons after the brightness slider is selected. This function modifies RGB data to change the brightness.
- Contrast:** Allows <Contrast> adjustment in the Y domain. The modification affects all color channels and all input types and is a direct multiplication of the Y data after YUV black level adjustment.
- Hue:** Allows <Hue> adjustment in the UV domain. The modification affects all color channels and all input types.
- Saturation:** Allows <Saturation> adjustment in the UV domain. The modification affects all color channels and all input types.
- Sharpness:** Allows <Sharpness> adjustment on the image.
- Advanced:** The advanced menu opens in two different ways, according to input type (see following pages).
- Reset Scheme:** Can be used to reset scheme (normal/sport/game/cinema/vivid) settings to factory value.

Sub-Menu “Advanced”



Figure 7.1.c “Advanced” menu for S-Video, CVBS, YPbPr, RGB+CS, and video mode of DVI/HDMI.



Figure 7.1.d “Advanced” menu for VGA and graphics mode of DVI/HDMI.

Color:



Figure 7.1.e “Color” menu for DVI/HDMI

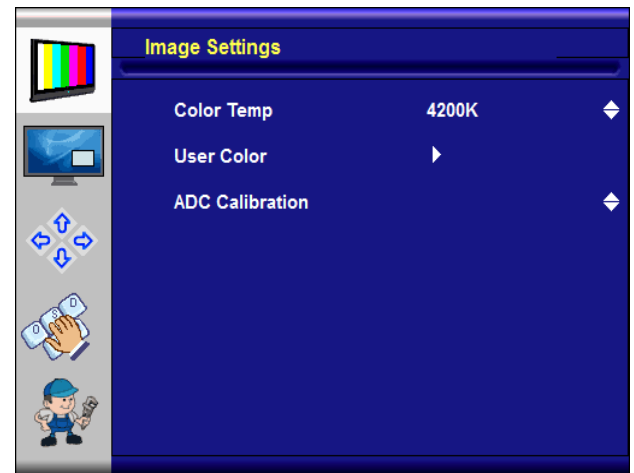
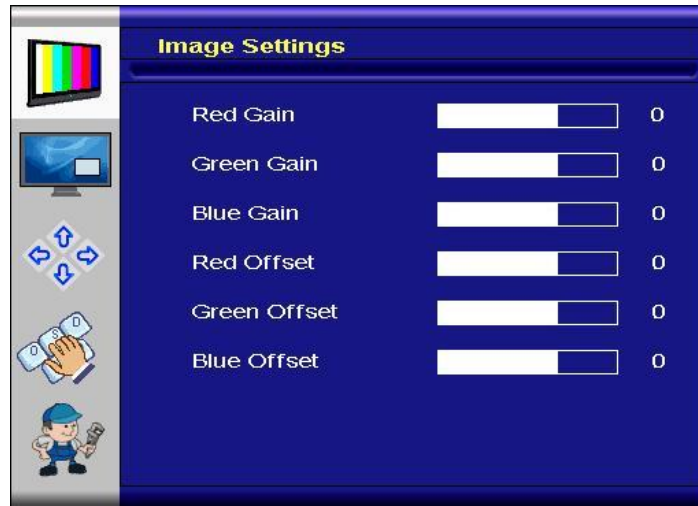

Figure 7.1.f “Color” menu for S-Video, CVBS, YPbPr, RGB+CS and VGA

- **Color Temp:** Allow selection of different color temperature schemes. Selections are user, sRGB, 4200K, 5000K, 5400K, 6500K, 7200K, 9300K.

- **User Color:** If the user has a preference other than the pre-set color temperatures, the menu below can be used to create a new color scheme.



- **Red Gain:** Boost adjustment on red.
- **Green Gain:** Boost adjustment on green.
- **Blue Gain:** Boost adjustment on blue.
- **Red Offset:** Base level increase on red.
- **Green Offset:** Base level increase on green.
- **Blue Offset:** Base level increase on blue.

- **ADC Calibration:** Performs an auto fine tuning on the ADC. Does not apply to digital inputs.

Noise Reduction:

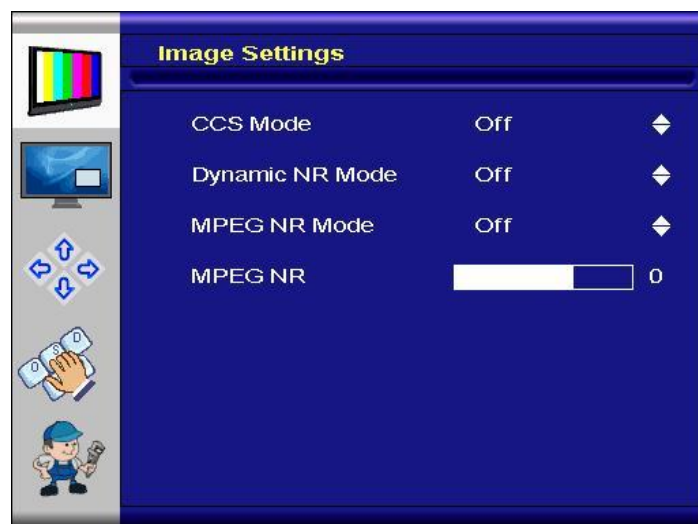

- **CCS Mode:** Changes Cross-Color Suppression between off/adaptive/normal. Adjust for best image.
- **Dynamic NR Mode:** Changes Dynamic Noise Reduction between low/medium/high/off/adaptive. High setting may cause loss of detail, adjust for best image.
- **MPEG NR Mode:** Enables/disables the MPEG NR Mode.
- **MPEG NR:** Allows the user to manually set the level of MPEG noise reduction.

Video Processing:

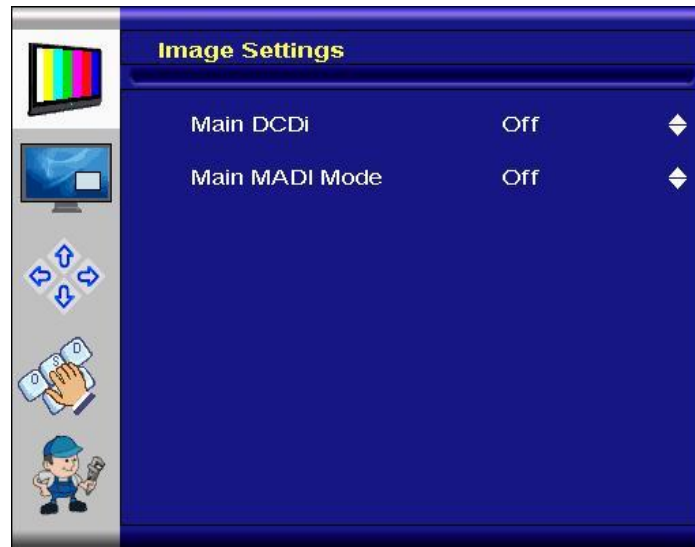

- **Main DCDi:** Turns DCDi on/off on main channel.
- **Main MADi Mode:** Changes Motion Adaptive De-Interlacing between normal/off/adaptive modes.

Film Mode & Scaling:

This feature can be used to adjust image when viewing 2:2/3:2 pulled-down video camera films.

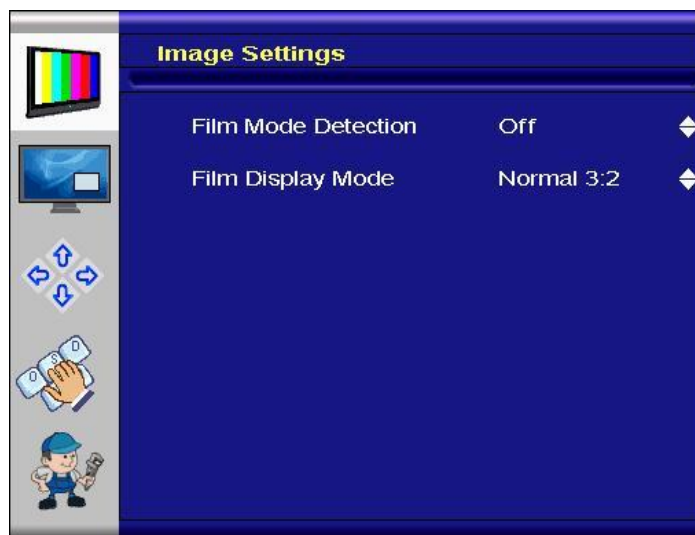

- **Film Mode Detection:** Selection of Video-3:2/Video-2:2/Video-3:2-2:2/off.
- **Film Display Mode:** Selection of Normal 3:2 or other future modes.

7.2 Sub-Menu “Display Settings“



- **Aspect Ratio:** Used to adjust display between full screen, panoramic, Letter Box Expand, Pillar Box and 1:1.

Panoramic is a technique that captures images with elongated fields of view. When a film or video that was not originally designed for widescreen is shown on a widescreen display, black bars are placed on the sides of the image. This is called *pillar boxing*. *Letterboxing* is the practice of transferring a film shot in a widescreen aspect ratio to standard-width video formats while preserving the film's original aspect ratio, by placing black bars above and below the image. *1:1* is a technique that captures images without changing resolution. The input resolution cannot be bigger than the panel resolution in horizontal or vertical.

- **PIP:** Picture-In-Picture can be used to display HDMI/DVI and another input at the same time.
- **Tiling:** The tiling function (for video wall applications) can be used with all input types.

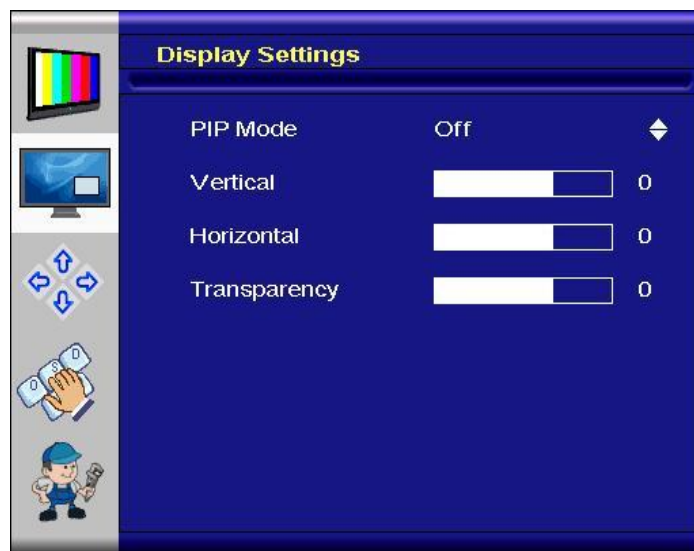

- **PIP Mode:** Can be toggled between Off, PAP-Tall, Side-by-Side, Small PIP and Large PIP. PIP position can be adjusted using the slider bars.

The following matrix shows the possible combinations of Main- and PIP Channels:

		Main Channel								
		VGA	YPbPr ¹⁾	RGB CS ²⁾	CVBS1	CVBS2	S-Video	DVI	HDMI ³⁾	
PIP	VGA	*	✓	✓	✓	✓	✓	✓	✓	✓
	YPbPr ¹⁾	✓	*	✗	✓	✓	✓	✓	✓	✓
	RGB CS ²⁾	✓	✗	*	✗	✗	✗	✓	✓	✓
	CVBS1	✓	✓	✗	*	✗	✗	✓	✓	✓
	CVBS2	✓	✓	✗	✗	*	✗	✓	✓	✓
	S-Video	✓	✓	✗	✗	✗	*	✓	✓	✓
	DVI	✓	✓	✓	✓	✓	✓	*	✗	✗
	HDMI ³⁾	✓	✓	✓	✓	✓	✓	✗	*	*

* One input port can be displayed simultaneously on Main and PIP channel.

- 1) Component
- 2) RGB with Composite Sync
- 3) Internal TMDS port on CON9, see sec. 12.2.6

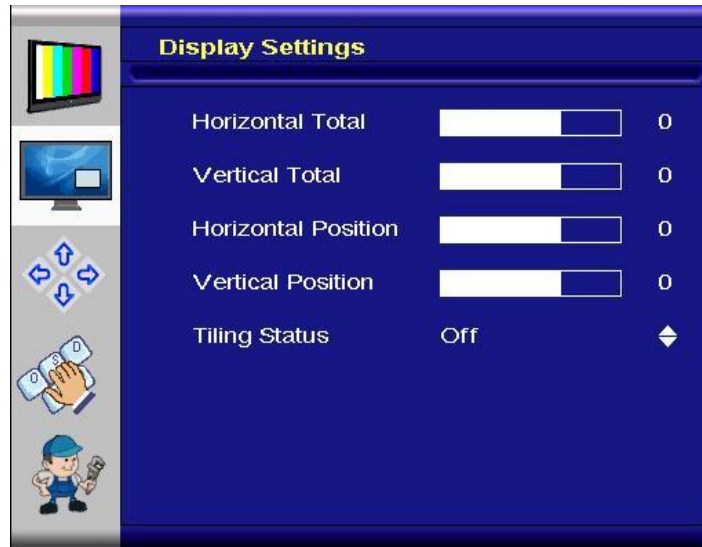

- **Horizontal Total:** Defines the total horizontal number of displays.
- **Vertical Total:** Defines the total vertical number of displays.
- **Horizontal Position:** Defines the horizontal position of the actual display unit.
- **Vertical Position:** Defines the vertical position of the actual display unit
- **Tiling Status:** Enables/disables the tiling function. If the PIP-Mode is PAP-Tall or side-by-side, the tiling status will be off and disabled.

Example: 3 by 3 video wall: Definition of **Horizontal/Vertical** display position:

Horizontal \ Vertical	1	2	3
1	1/1	2/1	3/1
2	1/2	2/2	3/2
3	1/3	2/3	3/3

Limitations:

- Tiling property cannot be used while PAP-Tall or Side-by-Side modes are active.
- PiP window tiling is not possible.
- Image and position menus are disabled while tiling is on.

Note:

- For best results, the Horizontal Total and Vertical Total value should be set to a value which is an integer divider of the input width or height, respectively. For example, if input is 1280x768, horizontal total has to be set to one of 2, 4, 5, 8 and vertical total has to be set to one of 2, 3, 4, 6, 8.

7.3 Sub-Menu “Position Settings“

Sub-Menu for video mode of HDMI, S-Video, composite and component inputs:



Figure 7.3.a: “Position Settings” menu for video mode of HDMI, S-Video, composite and component inputs.

- **Width:** Adjusts total width of the image by stretching or shrinking.
- **Height:** Adjusts total height of the image by stretching or shrinking.
- **Horizontal Start:** Changes the starting point of the image horizontally, without altering height.
- **Vertical Start:** Changes the starting point of the image vertically, without altering width.

Sub-Menu for VGA inputs:

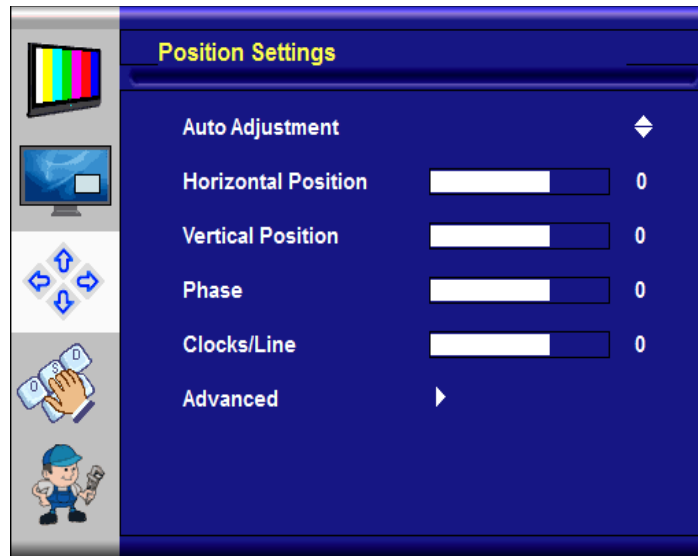

7.3.b (VGA): "Position Settings" menu for VGA.

- **Auto Adjustment:** Performs auto-adjust function on the image.
- **Horizontal/Vertical Position:** Used to alter placement of the image.
- **Phase:** This function is a slider to adjust the sampling phase of the analog interface. For optimum image quality, input pixels should be sampled at the ideal sampling points.
- **Clocks/Line:** This function is a slider to adjust the sample clock of the analog interface. This is helpful for improving the image quality for non-standard display modes.
- **Advanced:**

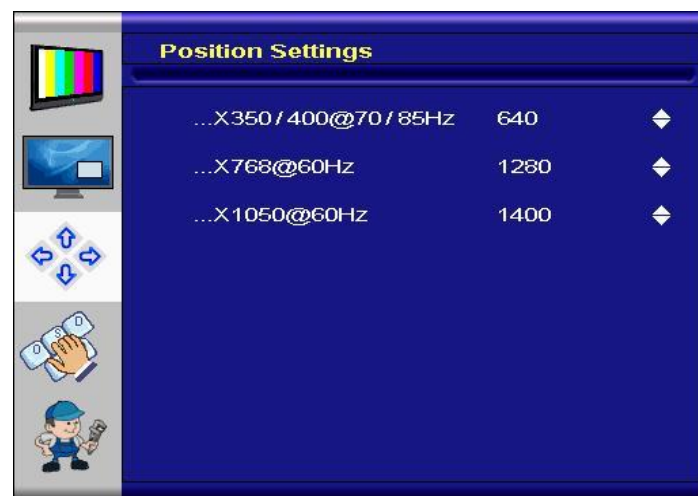

This function can be used to manually force some of the widely used difficult-to-detect modes which can be misinterpreted by the controller.

Submenu for graphics mode of HDMI:



- **1080p:** Select Video or Graphics optimization for 1080p content.
- **720p:** Select Video or Graphics optimization for 720p content.

Video: Internal algorithms are optimized for videos (moving content).

Graphics: Internal algorithms are optimized for graphic input (static content e.g. from an office PC).

7.4 Sub-Menu “OSD Settings“



- **Language:** Selects the language of the OSD menu: English, German, French, Italian, Spanish, Turkish, Danish.
- **Time Out:** This function determines after how many seconds the OSD will close itself.
- **Horizontal Flip:** Flips the OSD horizontal.
- **Vertical Flip:** Flips the OSD vertical.
- **Rotation:** Rotates the OSD.
- **OSD Zoom:** Changes OSD size.
- **Keypad Layout:** Selects 6-Button or 4-Button OSD-Keypad (see sec. 6.1).
- **Advanced:**
 - Horizontal:** This function can be used to move the OSD window on a horizontal line.
 - Vertical:** This function can be used to move the OSD window on a horizontal line.
 - Blend:** This function can be used to change the transparency of the OSD window.

7.5 Sub-Menu “Setup“



- **Factory Reset:** This function can be used to load back factory-loaded values.
- **Speed Mode:** In graphics mode, fast image transfer is supported.
- **Show Menu Of:** Changes the menu between main image and PIP if the PIP mode is on.
- **Input Search:** Toggles input search on/off.
- **Auto Brightness:** (Optional) Toggles automatic brightness control through external light sensor on/off.
- **Display On Counter:** (Optional) This counter shows how many hours the display has been switched on. If for example no valid input signal is found the display is switched off automatically - during this time this timer is not increased.
- **Power On Counter:** (Optional) This counter shows how many hours the board has been switched on. This counter increases as long as the board is powered and not switched to full power off mode by pressing the power key on the IR remote control or on the OSD keypad. This counter also increases when no valid input signal is found and the board is in sleep mode.
- **Main Input:** Shows the detected input mode (resolution and frame rate) of the main input channel.
- **PIP Input:** Shows the detected input mode (resolution and frame rate) of the PIP input channel.

8 Supported Input Modes

The Prisma-IIIIE can support the following input modes. Other modes can be implemented on request. Please ask your sales contact for more details.

8.1 S-Video, CVBS, RGB+CS

The Prisma-IIIIE is equipped with one S-Video connector and one RCA CVBS connector. There are also optional S-Video and CVBS connections through the side video connector CON14 as well as "RGB + Composite Sync". The RGB+CS input shares pins with the YPbPr input, so they cannot be used at the same time. The following table shows the basic characteristics of the supported standard video formats.

Resolution
720 x 480 @ 30(i) (NTSC)
720 x 576 @ 25(i) (PAL)

Table 1: Standard video formats supported via S-Video, CVBS and RGB+CS

8.2 Component

The Prisma-IIIIE accepts Component Video Input (YPbPr) through the side video connector CON14. The YPbPr input shares pins with the RGB+CS input so they cannot be used at the same time.

Resolution	Resolution
720 x 240 @ 30(i)	1920 x 540 @ 25(i)
720 x 480 @ 60	1920 x 540 @ 30(i)
720 x 288 @ 25(i)	1920 x 1080 @ 25
720 x 576 @ 50	1920 x 1080 @ 30
1280 x 720 @ 50	1920 x 1080 @ 50
1280 x 720 @ 60	1920 x 1080 @ 60

Table 2: Standard video formats supported via Component input

8.3 VGA

The factory preset supported input modes include:

Resolution	Resolution
640 x 480 @ 60 Hz (VESA)	1360 x 768 @ 60 Hz
800 x 600 @ 60 Hz (VESA)	1366 x 768 @ 60 Hz
1024 x 768 @ 60 Hz (VESA)	1368 x 768 @ 60 Hz
1280 x 768 @ 60 Hz	1600 x 1200 @ 60 Hz (VESA)
1280 x 1024 @ 60 Hz (VESA)	1920 x 1200 @ 60 Hz
1280 x 800 @ 60Hz	1920 x 1080 @ 60 Hz

Table 3: Factory preset modes for VGA input

8.4 DVI/HDMI

The integrated HDMI receiver is backward compatible with DVI 1.0 specifications, therefore both DVI and HDMI signals can be supplied to the DVI connector CON2 and to the internal HDMI connector CON9.

The factory preset supported graphic input modes include:

Resolution	Resolution
640 x 480 @ 60 Hz (VESA)	1360 x 768 @ 60 Hz
800 x 600 @ 60 Hz (VESA)	1366 x 768 @ 60 Hz
1024 x 768 @ 60 Hz (VESA)	1368 x 768 @ 60 Hz
1280 x 768 @ 60 Hz	1600 x 1200 @ 60 Hz (VESA)
1280 x 1024 @ 60 Hz (VESA)	1920 x 1200 @ 60 Hz
1280 x 800 @ 60 Hz	1920 x 1080 @ 60 Hz

Table 4: Factory preset modes for DVI/HDMI input (graphics)

The factory preset supported video input modes include:

Resolution	Resolution
720 x 480 @ 60 Hz	1280 x 720 @ 60 Hz
720 x 576 @ 50 Hz	1920 x 1080 @ 50 Hz
1280 x 720 @ 50 Hz	1920 x 1080 @ 60 Hz

Table 5: Factory preset modes for DVI/HDMI input (video)

9 Absolute Maximum Ratings

Item	Symbol	Min.	Max.	Unit	Note
Supply Voltage	V_{in}	-0.2	28	VDC	1, 2
Storage Temperature	T_{ST}	-35	+85	°C	
Operating Temperature	T_{OP}	-35	+80	°C	3

Note (1): Within operating temperature range.

Note (2): Permanent damage to the device may occur if maximum values are exceeded.

Note (3): Correct operation for Scaler IC STDP8028 is guaranteed from 0°C to +70°C. Specifications over the 0°C to +70°C operating temperature range are assured by design, characterization and correlation with statistical process controls. Please see Chapter 8.1 “Thermal Derating Characteristics”

9.1 Thermal Derating Characteristics

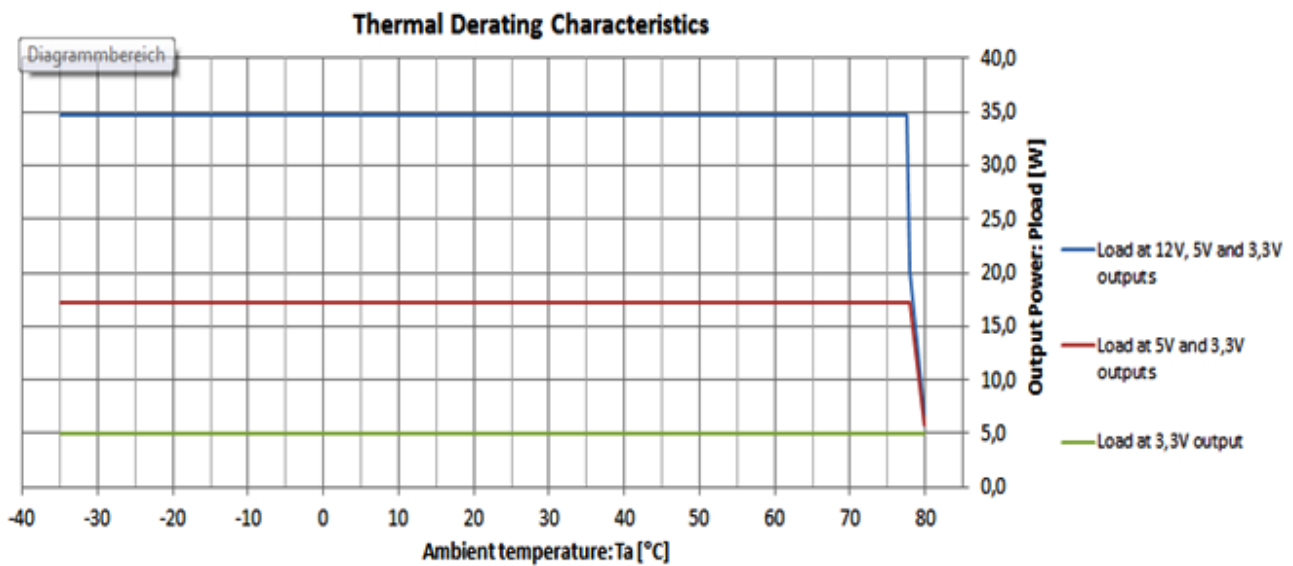

10 Electrical Specification

Remark: All values are average values of repeated measurements. Other Prisma-III E / panel combinations may have different electrical characteristics. Measurements were performed at 25°C, currents were measured at nominal supply voltage ($V_{in} = 12V$).

Prisma III E 12V

Item	Condition	MIN.	TYP.	MAX.	Unit	Note
Supply Voltage (V_{in})		11.7	12.0	28.0	VDC	1, 2
Input Current (@12V)	Power-off		17		mA	
	Sleep mode		240	260	mA	
	Board only		240	260	mA	
	1280*1024		2,3		A	3
Input Current (@5V) through CON16 low-power PSU	Power-off		21		mA	4

Note (1): Supply voltage limits are for the Prisma-III E, inverter and possibly panel supply limits must be met as well, if the inverter is to be powered by the Prisma-III E board or the panel SVCC setting is set to 12V.

Note (2): The 12V SVCC (panel supply voltage) and 12V V_{BKL} (inverter supply voltage) are directly taken from the input power rail. If a supply voltage other than 12V is used, only displays which require a panel power of 3,3V or 5,0V may be connected.

Connecting 24V input voltage to the 12V Prisma-III E can permanently damage your panel and backlight converter! Please contact your local sales representative if you are unsure about these limitations.

Note (3): Sample configuration: SXGA panel AUO G190EG02-V1.

Note (4): External power supply unit is placed in low power mode through GPIO control: +12V input voltage is switched off, only +5V is supplied through CON16 pin 1.

10.1 Maximum allowed Power Consumption for TFT Panels

Panel Power (V_{svcc})	Symbol	Max.	Unit	Note
3,3V	I_{svcc}	1,5	A	1, 2, 5, 6
5V	I_{svcc}	2,6	A	1, 2, 3, 6
12V (V_{in})	I_{svcc}	2,6	A	1, 2, 4, 6

10.2 Maximum allowed Power Consumption for Backlight Inverter (V_{BKL})

Item	Symbol	Max.	Unit	Note
+5V Backlight power on CON23	I_{BKL}	2,0	A	2, 3, 4, 6
+12V Backlight power on CON23	I_{BKL}	3,0	A	2, 5, 6

Note (1): Actual SVCC voltage is selected by software configuration.

Note (2): Supply current limits are subject to balancing (cross load) and thermal issues. Given limits can be guaranteed for all combinations of SVCC and BKL power voltages. In case your application has higher requirements, please ask your sales contact if the desired application is possible with Prisma-III E.

Note (3): The Prisma-III E generates the voltage 5V from the 12V, the power limitation for the 5V group together {5V Backlight, 5V SVCC, + 5V OUT (CON16)} is approx. 17.5W. At temperatures above 70°C, the power must be further reduced, please see sec. 8.1 "Thermal Derating Characteristics". Please contact Distec sales to discuss possible solutions in case the limit might be reached.

Note (4): The power limitation for the group {12V SVCC, 5V Backlight} is 32W. At temperatures above 70°C, the power must be further reduced, please see sec. 8.1 "Thermal Derating Characteristics". Please contact Distec sales to discuss possible solutions in case the limit might be reached.

Note (5): The power limitation for the group {12V Backlight, 3.3V SVCC} is 35W. At temperatures above 70°C, the power must be further reduced, please see sec. 8.1 "Thermal Derating Characteristics". Please contact Distec sales to discuss possible solutions in case the limit might be reached.

Note (6): All power drawn from the board must not exceed 55W. At temperatures above 70°C, the power must be further reduced, please see sec. 8.1 "Thermal Derating Characteristics".

Attention:

If an input voltage of 24V is used on a 12V board, only 24V inverters can be connected to the backlight supply connector CON23, and 12V panels cannot be connected to the LVDS connector.

Connecting 24V input voltage to the 12V variant of Prisma-III E can permanently damage your panel and backlight converter! Please contact your local sales representative if you are unsure about these limitations.

11 Mechanical Specification

ITEM	DESCRIPTION	REMARKS
Length	149.9mm	± 0.2 mm
Width	110.0mm	± 0.2 mm
Height (top side)	13.3 mm	± 0.2 mm
Height (PCB)	1.7mm	± 0.1 mm
Height (bottom side)	3.5mm	± 0.1 mm
Weight	132g	

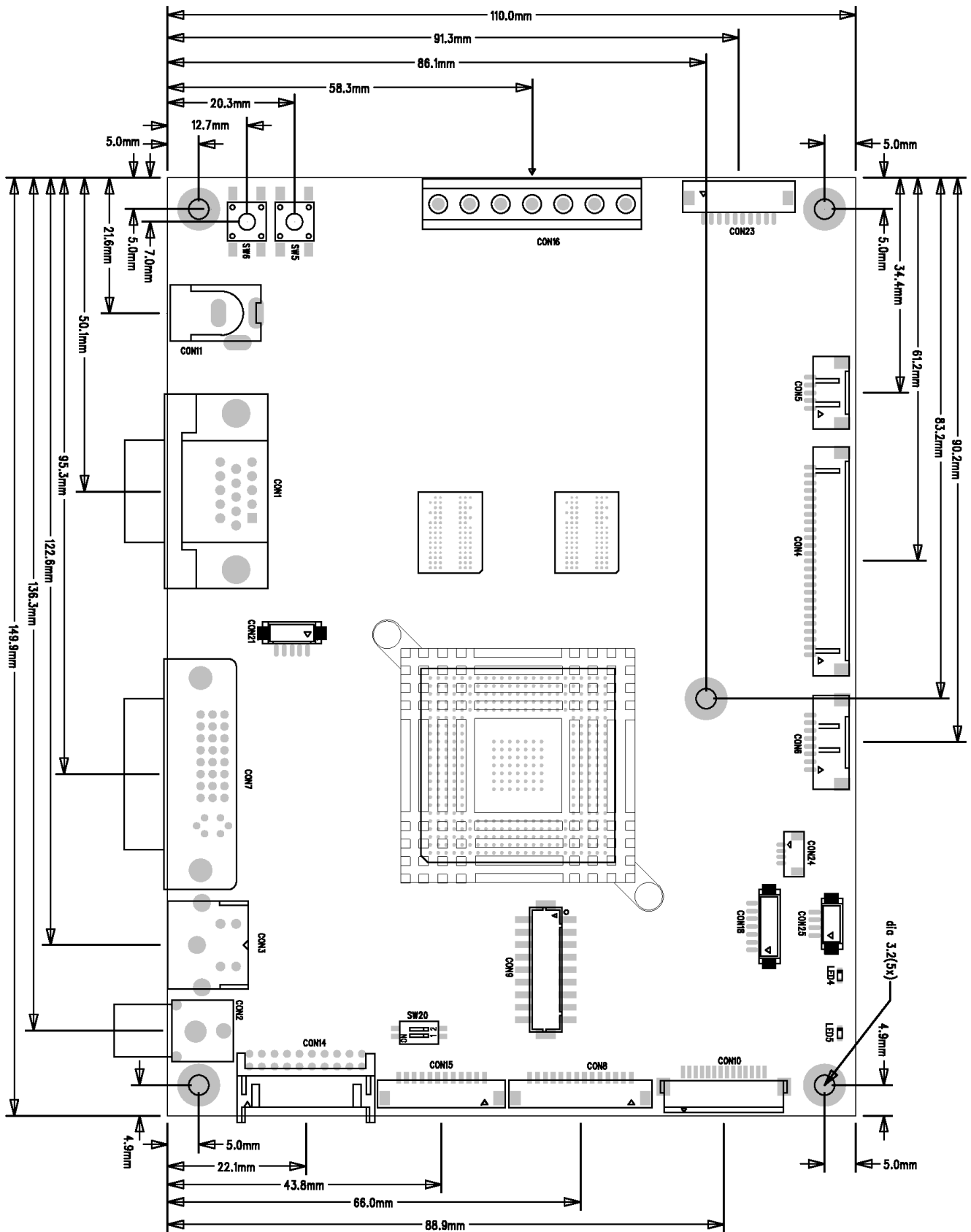

Input Connectors on Front Side:

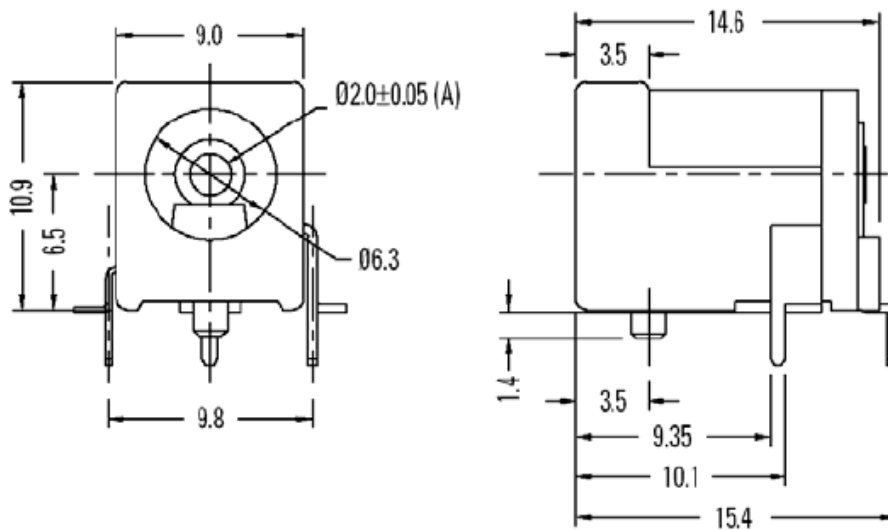
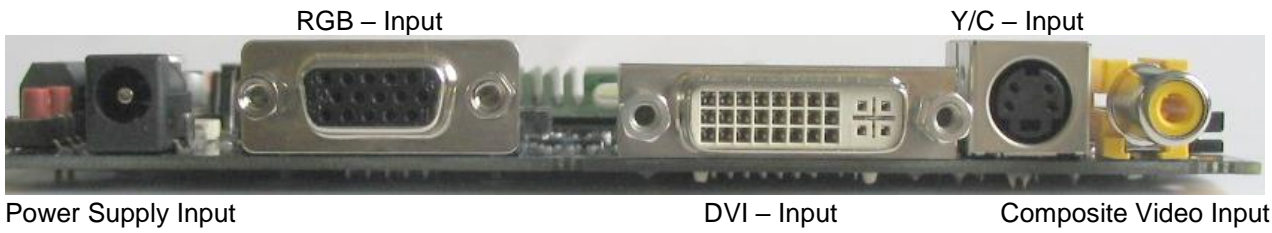

CON11: Power Supply Input

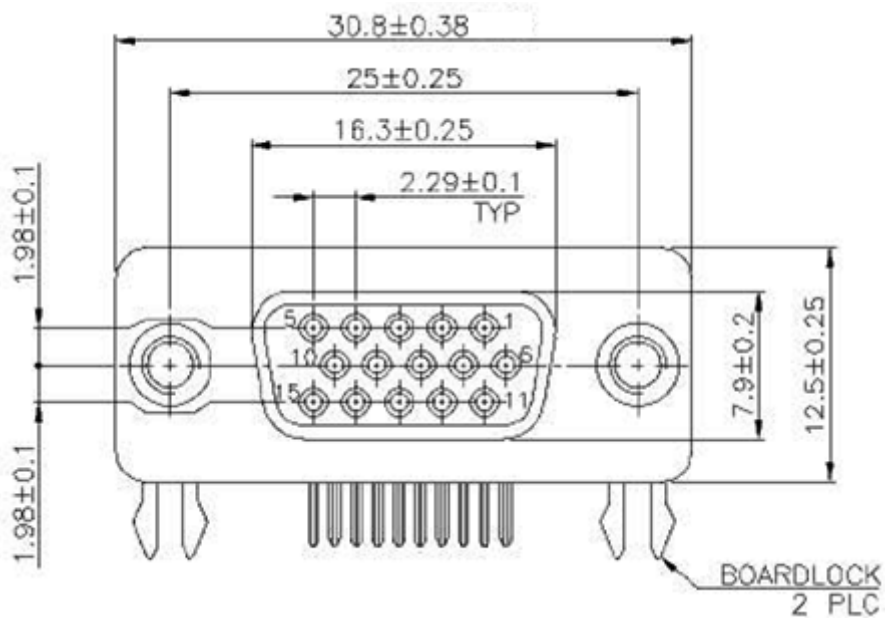

CON1: Analog VGA Input

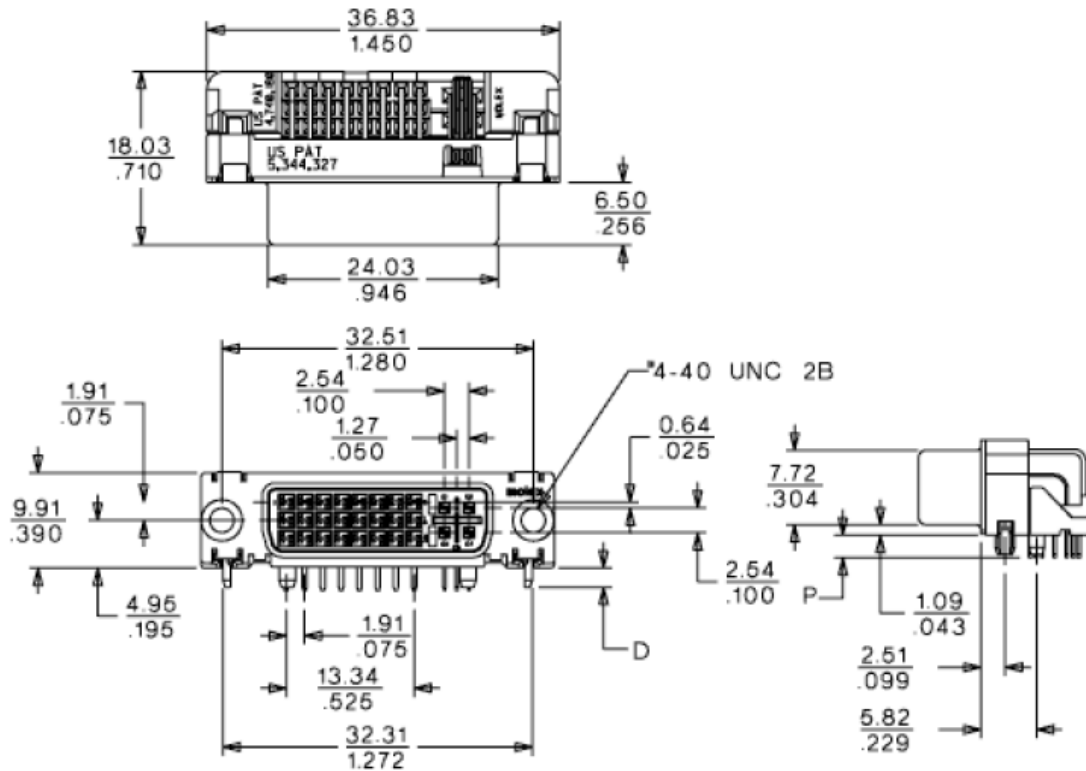

CON7: DVI Connector

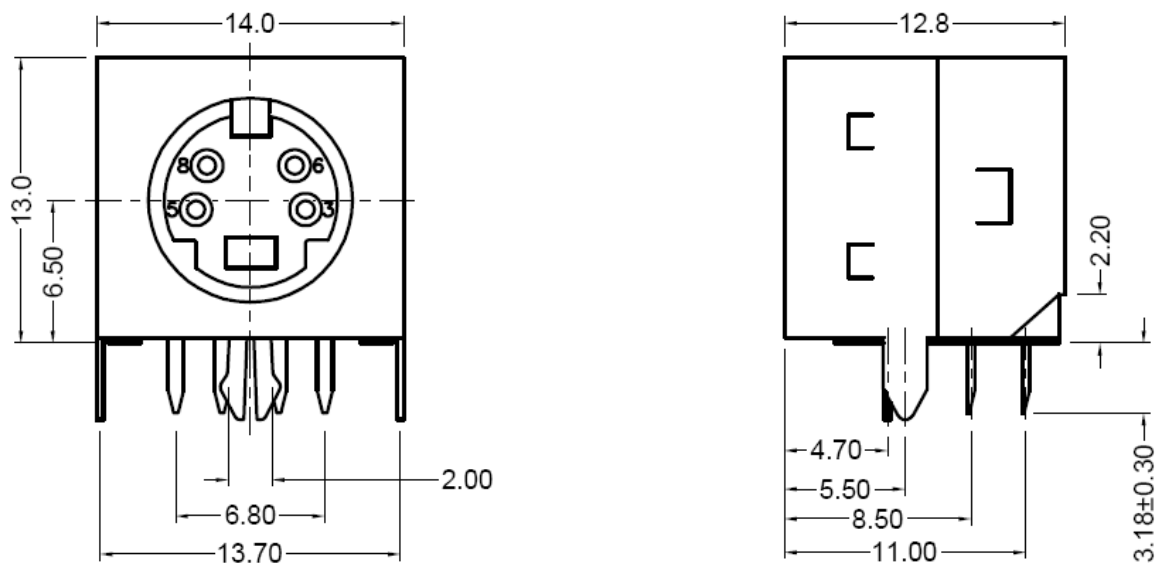

CON3: S-Video Connector

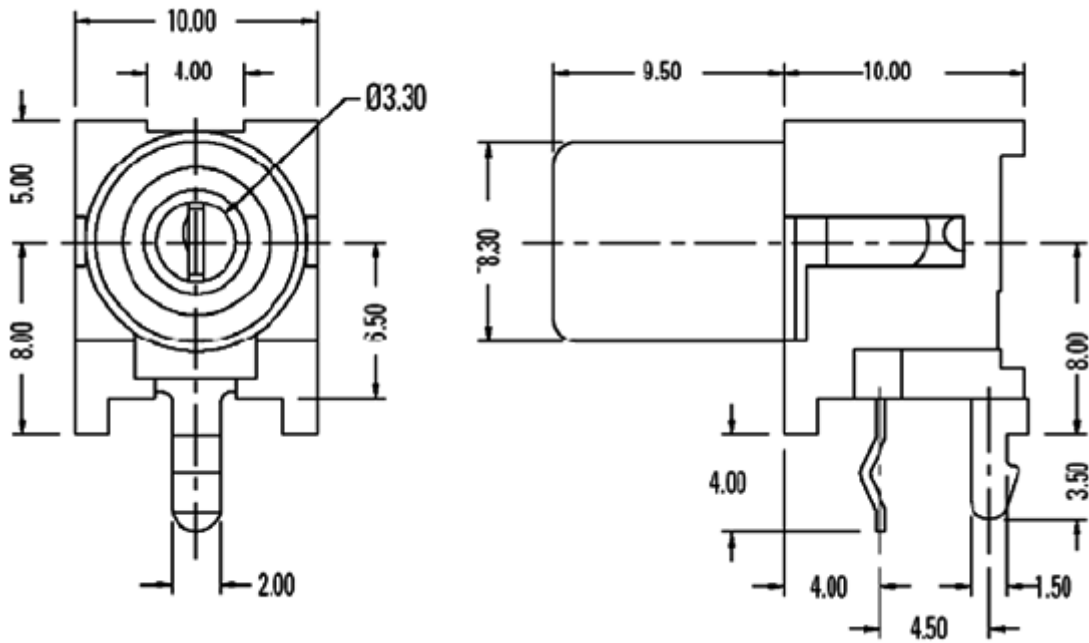

CON2: Composite Video Input

12 Connectors and Switches

The following drawing shows the input and output interfaces of the Prisma-III E. The design is implemented as a single printed circuit board.

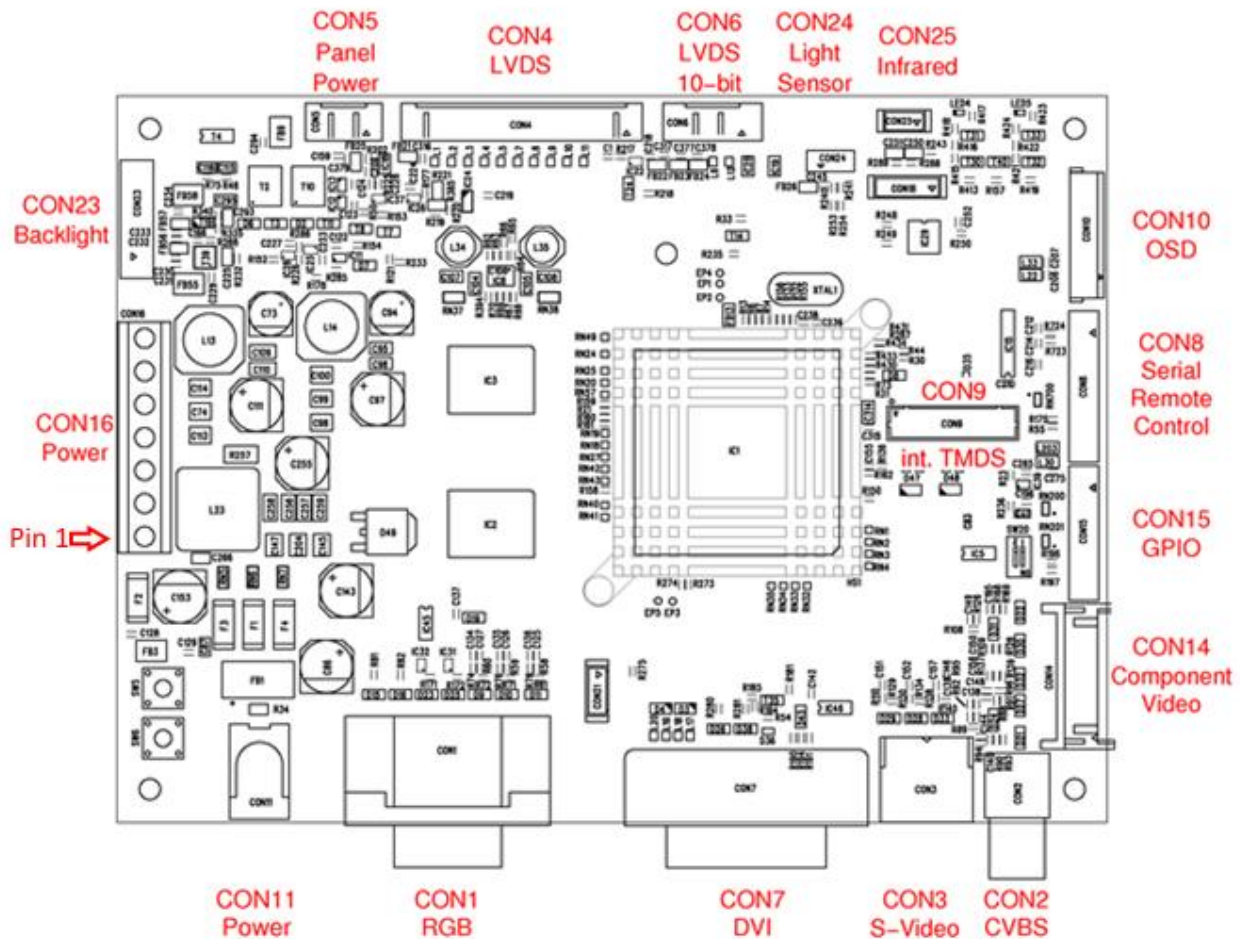

12.1 Overview

CON	DESCRIPTION	TYPE	MANUFACTURER
CON1	Analog VGA Input	15-pin H-DSUB female	---
CON2	Composite Video Input	RCA	e.g. Kycon
CON3	S-Video Input	4-Pin Mini DIN female	e.g. Kycon
CON4	Dual LVDS	DF14-25P-1.25H	Hirose
CON5	Additional LVDS power	DF14-5P-1.25H	Hirose
CON6	Extra LVDS pair for 10-bit	DF14-8P-1.25H	Hirose
CON7	DVI	DVI-I female	e.g. Molex
CON8	Serial Programming / RS232 Remote Control	DF13-14P-1.25H	Hirose
CON9	TMD5 (internal DVI/HDMI)	2203V-18-T-R	Nexus
CON10	OSD Control	52271-1479	Molex
CON11	Power Supply Input	Power Jack 2.0 mm	e.g. Kycon
CON14	Component Video In	DF11-20DP-2DS	Hirose
CON15	GPIO	DF13-12P-1.25H	Hirose
CON16	Power Supply Connector	Adapter bushing	---
CON23	Backlight Power Supply	DF13-10P-1.25H	Hirose
CON24	Light Sensor	501331-0407	Molex
CON25	Infrared	DF13B-4P-1.25V	Hirose

12.2 Input Connectors

12.2.1 CON1: RGB – ANALOG INPUT CONNECTOR

Pin	Signal	Description
1	RED	Analog Red
2	GREEN	Analog Green
3	BLUE	Analog Blue
4	NC	Not connected
5	GND	Ground
6	GND	Ground
7	GND	Ground
8	GND	Ground

Pin	Signal	Description
9	VGA_5V	Fused VCC
10	GND	Ground
11	NC	Not Connect
12	VGA_SDA	DDC Data
13	HSYNC	Horizontal Sync Input
14	VSYNC	Vertical Sync Input
15	VGA_SCL	DDC Clock

12.2.2 CON2: C-VIDEO INPUT CONNECTOR

Pin	Signal	Description
1	GND	Ground
2	CVBS1_IN	Composite video signal

12.2.3 CON3: S-VIDEO INPUT CONNECTOR

Pin	Signal	Description
3	GND	Ground-
5	GND	Ground-

Pin	Signal	Description
6	Y	Luminance
8	C	Chrominance



12.2.4 CON7: DVI CONNECTOR

Pin	Signal	Description
1	TMDS2-	Differential TMDS Data 2-
2	TMDS2+	Differential TMDS Data 2+
3	GND	TMDS Shield
4	NC	Not connected
5	NC	Not connected
6	DVI_SCL	DDC EDID data clock
7	DVI_SDA	DDC EDID data
8	DVI_VS	Analog VSYNC
9	TMDS1-	Differential TMDS Data 1-
10	TMDS1+	Differential TMDS Data 1+
11	GND	TMDS Shield
12	NC	Not connected
13	NC	Not connected
14	DVI_5V	5V / 100mA Power Supply
15	GND	Ground

Pin	Signal	Description
16	DISPDET	Hot Plug Detection
17	TMDS0-	Differential TMDS Data 0-
18	TMDS0+	Differential TMDS Data 0+
19	GND	TMDS Shield
20	NC	Not connected
21	NC	Not connected
22	GND	TMDS Clock Shield
23	TMDSSCL+	Differential TMDS Clock +
24	TMDSCL-	Differential TMDS Clock -
C1	NC	Not connected
C2	NC	Not connected
C3	NC	Not connected
C4	NC	Not connected
C5	NC	Not connected
C6	NC	Not connected

12.2.5 CON8: SERIAL COMMUNICATION CONNECTOR

Pin	Signal	Description
1	T1_OUT / TXD	RS232 / serial output port
2	R1_IN / RXD	RS232 / serial input port
3	NC	Not connected
4	NC	Not connected
5	NC	Not connected
6	NC	Not connected
7	DCD	Not connected

Pin	Signal	Description
8	DSR	Not connected
9	RTS	Not connected
10	DTR	Not connected
11	CTS	Not connected
12	+3.3V	+3.3V power supply
13	GND	Ground
14	NC	Not connected

* RS232 Rx / Tx signals: +/-12V typical, +/-5V minimum, and +/-15V absolute maximum rating.

Use CON8 together with cable KA-30-002 to configure the board with the Data Display MarsRover software or to control the board via Remote OSD.

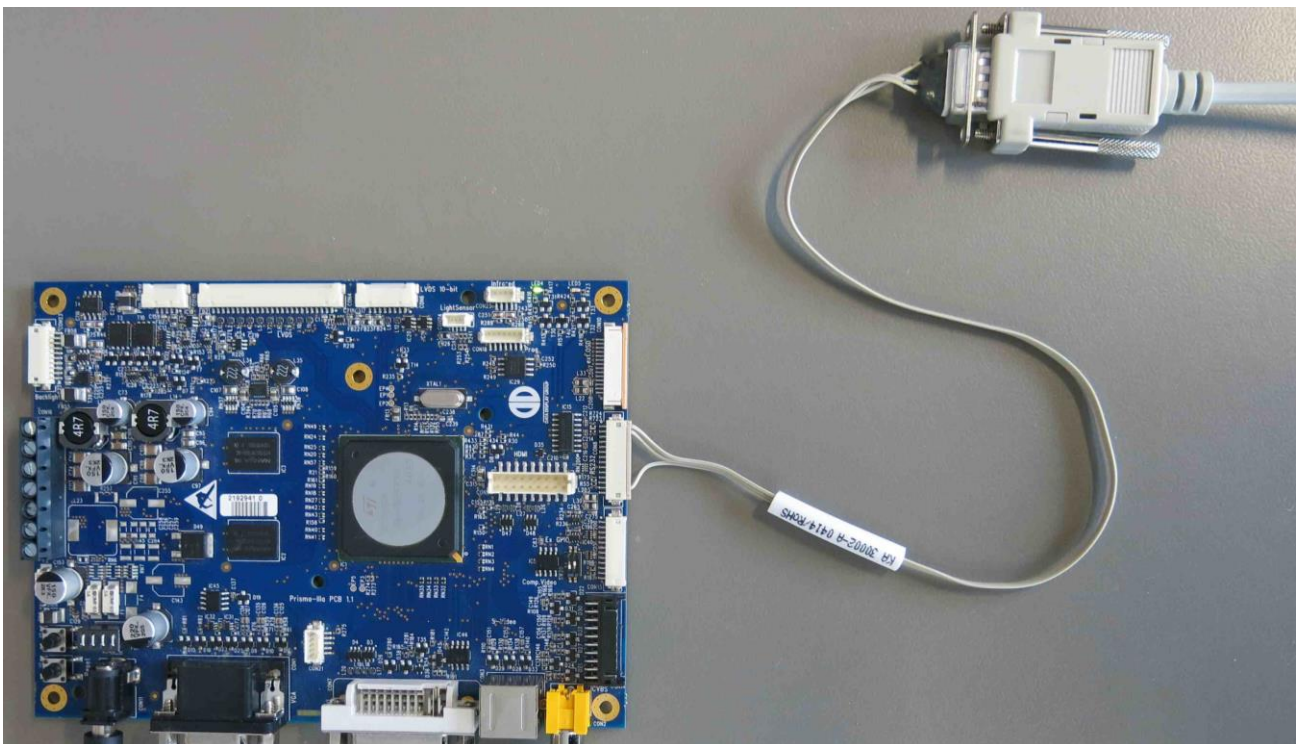

12.2.6 CON9: TMDS (HDMI/DVI) INPUT CONNECTOR

With CON9 Prisma-III E provides a second input connector for TMDS signals (HDMI and DVI). Note that this connector is disabled by default, CON9 must be activated by customized FW or with the MarsRover configuration software (see sec. 4).

Pin	Signal	Description
1	HDMI_HP	Source Hot Plug Detection
2	HDMI_VCC	+5V
3	HDMI_PLUG	Sink cable plug detection*
4	HDMI_SDA	DDC Data
5	HDMI_SCL	DDC Clock
6	CEC	Optional HDMI CEC
7	HDMI_RXC-_IN	Differential TMDS Clock-
8	GND	Ground
9	HDMI_RXC+_IN	Differential TMDS Clock+

Pin	Signal	Description
10	HDMI_RX0-_IN	Differential TMDS Data 0-
11	GND	Ground
12	HDMI_RX0+_IN	Differential TMDS Data 0+
13	HDMI_RX1-_IN	Differential TMDS Data 1-
14	GND	Ground
15	HDMI_RX1+_IN	Differential TMDS Data 1+
16	HDMI_RX2-_IN	Differential TMDS Data 2-
17	GND	Ground
18	HDMI_RX2+_IN	Differential TMDS Data 2+

* Connect to standard HDMI connector pin-17 or standard DVI connector pin-15 (both are ground); the ground connection on this pin is used as flag to detect an active connection.

The following cables from Data Display can be used to connect to CON9. They provide standard DVI and HDMI connectors:

DVI Cable

KA-30-382 Cable DVI-D Female / PCompactMedia 80cm



HDMI Cable

KA-30-577 Cable HDMI-A Male / PCompactMedia 80cm



12.2.7 CON10: OSD CONTROL PANEL CONNECTOR

Pin	Signal	Description
1	GND	GND
2	+5V**	+5V supply**
3	+3V	+3V supply
4	POWER_ON/ OFF	System power on/off
5	LED_GREEN	Status LED green
6	LED_RED	Status LED red
7	LBADC_IN1	For use with voltage controlled keypad

Pin	Signal	Description
8	SOURCE	TBD
9	KEY_RIGHT	OSD – Key RIGHT
10	KEY_LEFT	OSD – Key LEFT
11	KEY_DOWN	OSD – Key DOWN*
12	KEY_UP	OSD – Key UP*
13	ENTER	OSD - Key ENTER*
14	MENU	OSD - Key MENU*

* OSD signals and definitions in the chart are for the standard 6-button OSD. When the optional 4-button OSD will be used, pin-14 is key-up, pin-13 is key-down, pin-12 is key-left and pin-11 is key-right.

** +5V not available during full power-off mode.

12.2.8 CON11: POWER SUPPLY CONNECTOR

Pin	Signal	Description
Center	+12V/+24V	12V/24V * Power supply (up to 3A)

Pin	Signal	Description
Bottom	GND	Ground

* **Connecting 24V input voltage to the 12V Prisma-III E can permanently damage your panel and backlight converter!** Please see sec. 10 for more details.

12.2.9 CON14: COMPONENT VIDEO INPUT CONNECTOR

Pin	Signal	Description
1	Analog 1	B / Pb (Note 1)
2	GND	Ground
3	Analog 2	G / Y (Note 1)
4	GND	Ground
5	Analog 3	R / Pr (Note 1)
6	GND	Ground
7	Analog 4	CS / none (Note 1)
8	GND	Ground
9	+3.3V	+3.3V supply
10	SCL	I2C clock

Pin	Signal	Description
11	SDA	I2C data
12*	+5V (Note 2)	+5V supply
13	GND	Ground
14	GPIO_CON14	
15	Analog 5	None (Note3)
16	GND	Ground
17	Analog 6	None (Note3)
18	GND	Ground
19	Analog 7	CVBS2
20	GND	Ground

Note (1): Depending on RGBCS or Component mode (sec. 6.3 shows how to select a specific mode).

Note (2): +5V not available during full power-off mode.

Note (3): Reserved for customisation: These inputs can be configured as additional analog video inputs upon customer request.

12.2.10 CON15: GPIO

External GPIO pins are open-drain, pulled up to 3.3V by 4.7kOhm resistor.

Pin	Signal	Description
1	+3.3V	3.3V Power supply
2*	EXT_GPIO_0	General Purpose Port 0
3*	EXT_GPIO_1	General Purpose Port 1 / Power On-Off
4	EXT_GPIO_2	General Purpose Port 2
5	EXT_GPIO_3	General Purpose Port 3
6	EXT_GPIO_4	General Purpose Port 4

Pin	Signal	Description
7	EXT_GPIO_5	General Purpose Port 5
8	EXT_GPIO_6	General Purpose Port 6
9	EXT_GPIO_7	General Purpose Port 7
10	SCL	
11	SDA	
12	GND	Ground

* Only GPIO_0 and GPIO_1 are available during full power-off mode. This also depends on setting of SW20.

12.2.11 CON16: POWER SUPPLY CONNECTOR

Pin	Signal	Description
1	+5V	5V/350mA low power mode supply
2	GND	Ground
3	+12V/+24V*	12V/24V* Power supply (up to 5A)
4	EXT_PWR_PULL_UP	Externally provided pull-up signal for pin 5 + 6

Pin	Signal	Description
5	EXT_PWR_ON#	Low active power on signal for power supply remote control
6	EXT_PWR_ON	High active power on signal for power supply remote control
7	+5V OUT	+5V output, max. 300mA (not available in low-power mode)

* Connecting 24V input voltage to the 12V variant of Prisma-III E can permanently damage your panel and backlight converter! Please see sec. 10 for more details.

12.2.12 CON24: LIGHT AND TEMPERATURE SENSOR CONNECTOR

Pin	Signal	Description
1	+3.3V	3.3V Power supply
2	GND	Ground

Pin	Signal	Description
3	SCL	I2C Clock
4	SDA	I2C Data

The ambient light sensor **ZU-02-412** can be attached to Prisma-III E to automatically adjust the panel brightness according to the ambient light. Fitting cable to CON24: **KA-30-786**.



Additionally, the temperature sensor **ZU-02-389** is available to check and control the temperature of a panel or monitor. FW support is provided upon request. Fitting cable to CON24: **KA-30-323**.

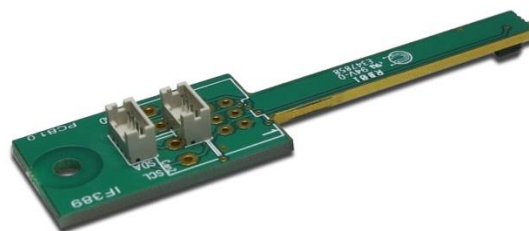

12.2.13 CON25: IR REMOTE CONTROL RECEIVER CONNECTOR

☞ See also section 6.2.

Pin	Signal	Description
1	IR	Demodulated IR signal
2	+3.3V	3.3V Power supply

Pin	Signal	Description
3*	+5V	5V/1A Power supply *
4	GND	Ground

* +5V not available during full power-off mode. Keep attention of the total allowed load on 5V rail using the power calculator.

12.3 Output Connectors

12.3.1 CON4: LVDS CONNECTOR

Pin	Signal	Description
1*	SVCC	Switched panel power supply +3,3V/ +5V/ 12V(Vin) (fused)
2*		
3	GND	Ground
4		
5**	TXB3+	LVDS data 1st pixel
6	TXB3-	LVDS data 1st pixel
7	TXBCL+	LVDS clock 1st pixel
8	TXBCL-	LVDS clock 1st pixel
9	TXB2+	LVDS data 1st pixel
10	TXB2-	LVDS data 1st pixel
11	TXB1+	LVDS data 1st pixel
12	TXB1-	LVDS data 1st pixel
13	TXB0+	LVDS data 1st pixel

Pin	Signal	Description
14	TXB0-	LVDS data 1st pixel
15	TXA3+	LVDS data 2nd pixel
16	TXA3-	LVDS data 2nd pixel
17	TXACL+	LVDS clock 2nd pixel
18	TXACL-	LVDS clock 2nd pixel
19	TXA2+	LVDS data 2nd pixel
20	TXA2-	LVDS data 2nd pixel
21	TXA1+	LVDS data 2nd pixel
22	TXA1-	LVDS data 2nd pixel
23	TXA0+	LVDS data 2nd pixel
24	TXA0-	LVDS data 2nd pixel
25	EBKL	Enable backlight signal

* Important note: Prisma-IIIIE 12V SVCC is directly connected to the power supply. **Connecting 24V input voltage to the 12V variant of Prisma-IIIIE can permanently damage your panel and backlight converter!** Please see sec. 10 for more details.

** LVDS channels A and B can be swapped upon request from customer.

12.3.2 CON5: PANEL EXTRA POWER CONNECTOR

Pin	Signal	Description
1	LVDS_OPT_0	Selectable +3.3V/GND LVDS Option pin 0
2,3*	SVCC	Switched panel power supply +3,3V/ +5V/ 12V(Vin) (fused)
4,5	GND	Ground

* Please see important note to CON4 in sec. 12.3.1.

12.3.3 CON6: LVDS 10-BIT CONNECTOR

Pin	Signal	Description
1	GND	Ground
2	TXB4+	LVDS data 1st pixel
3	TXB4-	LVDS data 1st pixel
4	TXA4+	LVDS data 2nd pixel
5	TXA4-	LVDS data 2nd pixel
6	LVDS_OPT_1	+3.3V/GND selectable LVDS Option pin 1
7	LVDS_OPT_2	+3.3V/GND selectable LVDS Option pin 2
8*	LVDS_OPT_3	+5V/+3.3V/GND selectable LVDS Option pin 3

* +5V not available during full power-off mode.

12.3.4 CON23: BACKLIGHT SUPPLY CONNECTOR

Pin	Signal	Description
1*	VBKL 12V/24V	Switched backlight power supply
2	GND	Ground
3	BKLT_EN	Enable backlight signal
4	BRT_ADJ	Brightness control signal
5	+5V	5V power supply
6	+5V	5V power supply
7*	VBKL 12V/24V	Switched backlight power supply
8*	VBKL 12V/24V	
9	GND	Ground Ground
10	GND	

* Important note: The Prisma-III E backlight power is directly connected to the power supply. **Connecting 24V input voltage to the 12V Prisma-III E can permanently damage your panel and backlight converter!**
Please see sec. 10 for more details.

12.4 Switches

There are two key switches on the board for local operation.

SW5 is the power switch to switch the board on and off.

SW6 is the reset switch to force a hard reset.

Switch **SW20** is used to configure EXT_GPIO_0 and EXT_GPIO_1.

SW20.1 is located next to CON15, SW20.2 is located next to IC5. “On” position is when the slider is moved towards CON2 (CVBS RCA jack), “Off” position is set when the slider is moved towards CON9.

Switch	Switch Position	Setting	Remarks
SW20.1	0 (off, default)	LPM_GPI	Input only
	1 (on)	EXT_GPIO_0	
SW20.2	0 (off, default)	Power-On/Off	Parallel to SW5
	1 (on)	EXT_GPIO_1	

Power-On/Off is the only function that is accessible with the standard firmware. Any other use of the GPIO pins has to be discussed with Distec Sales and requires special firmware support.

13 Supported Panels and Backlights (Inverter/Converter)

Panels and Backlights Options (Note 1)	Hardware Options
Panel Voltage	3,3V
	5V
	12V
Pixel Per Clock	1
	2
Option Pin 0 Voltage Level	0V
	3,3V
Option Pin 1 Voltage Level	0V
	3,3V
Option Pin 2 Voltage Level	0V
	3,3V
Option Pin 3 Voltage Level	0V
	3,3V
	5V
Backlight Voltage	5V
	12V
Backlight Control Type	Analog
	PWM
Voltage Level of PWM Signal	3,3V
	5V
Analog Voltage Level Range	0V - 5V
Voltage Level of Backlight Enable Signal	3,3V
	5V

Note 1: The Prisma-III E can support single/dual pixel 6/8/10 bit LVDS panels up to a resolution of WUXGA at 60Hz, or UXGA at 75Hz. For eDP panels an LVDS2eDP interface **ZU-09-034** is available from Data Display.

14 Appendix: PSU low-power-control timings (CON16 pin 5&6)

The time between power-on/off to PSU signal state change may differ between different kits, mainly for the power-off, since the system first goes through a panel-power-down sequence which is different for every kit. Following measurements have been taken with a Samsung LTM170EU-L21 panel with C&C GH053A inverter and are average values. Given values are for the power-on/off button. IR works ~40ms faster for the first step in each case.

Power on timings:

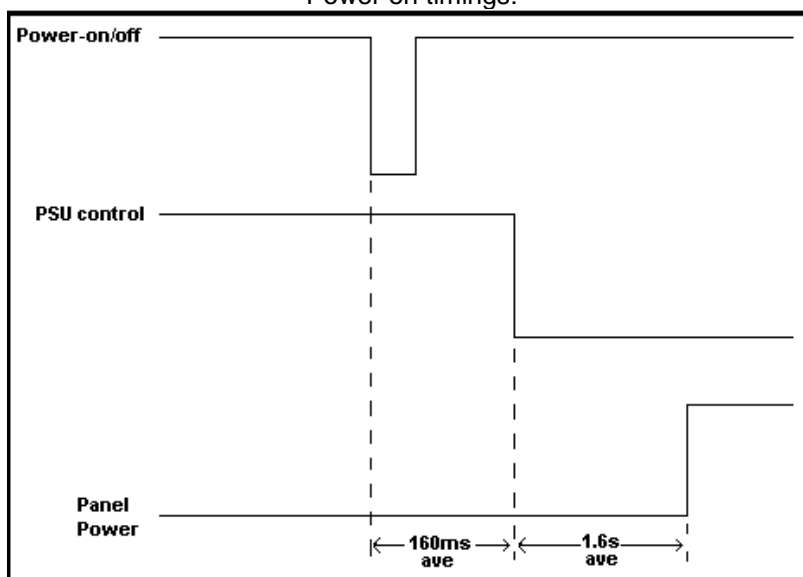

Power off timings:

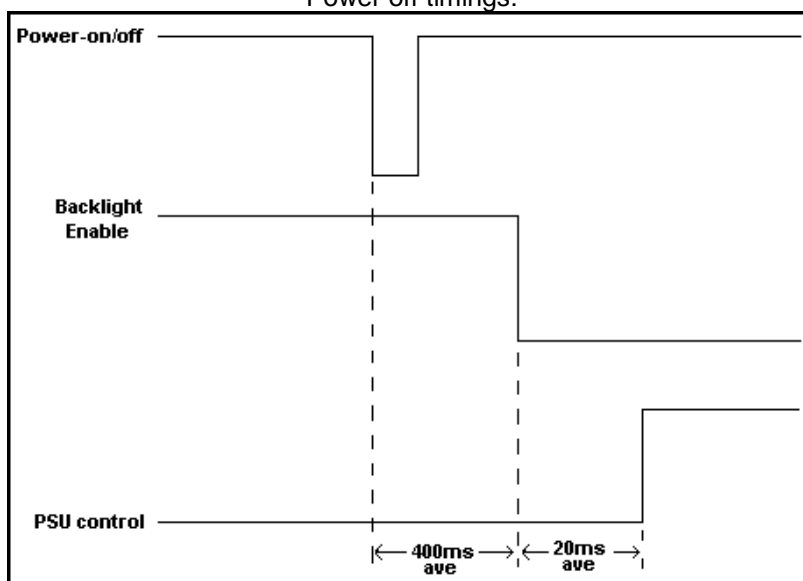

15 Hardware Information

Part Number	Description	Operating Temperature Range	Input Voltage	Note
PR-01-320	PrismaIIIA-00-12RVD	-20°C..+70°C	12V	1
PR-01-321	PrismaIIIA-01-24RVD	-20°C..+70°C	24V	1
PR-01-322	PrismaIIIE-00-12RVD	-35°C.. +80°C	12V	

Note 1: Please refer to Prisma-IIIA Datasheet.

Our company network supports you worldwide with offices in Germany, Austria, Switzerland, the UK and the USA. For more information please contact:

Headquarters

Germany



FORTEC Elektronik AG

Augsburger Str. 2b
82110 Germering

Phone: +49 89 894363-0
E-Mail: sales@fortecag.de
Internet: www.fortecag.de

Fortec Group Members

Austria



FORTEC Elektronik AG

Office Vienna

Nuschinggasse 12
1230 Wien

Phone: +43 1 8673492-0
E-Mail: office@fortec.at
Internet: www.fortec.at

Germany



Distec GmbH

Augsburger Str. 2b
82110 Germering

Phone: +49 89 894363-0
E-Mail: info@distec.de
Internet: www.distec.de



FORTEC Elektronik AG

Lechwiesenstraße 9
86899 Landsberg am Lech

Phone: +49 8191 91172-0
E-Mail: sales@fortecag.de
Internet: www.fortecag.de

Switzerland



ALTRAC AG

Bahnhofstraße 3
5436 Würenlos

Phone: +41 44 7446111
E-Mail: info@altrac.ch
Internet: www.altrac.ch

United Kingdom



Display Technology Ltd.

Osprey House, 1 Osprey Court
Hichingbrooke Business Park
Huntingdon, Cambridgeshire, PE29 6FN

Phone: +44 1480 411600
E-Mail: info@displaytechnology.co.uk
Internet: www.displaytechnology.co.uk

USA



Apollo Display Technologies, Corp.

87 Raynor Avenue,
Unit 1 Ronkonkoma,
NY 11779

Phone: +1 631 5804360
E-Mail: info@apolloDisplays.com
Internet: www.apolloDisplays.com