



OUR GLOBAL
COMPETENCE
CENTRES

 APOLLO DISPLAY
TECHNOLOGIES



 DISTEC



 DISPLAY
TECHNOLOGY



Datasheet

Tianma

P0840XGF1MB00

TI-01-012

SPECIFICATION

Preliminary Specification

Final Specification

Description **8.4” 1024x768 TFT-LCD Module**
Part Number **P0840XGF1MB00**

Customer	Industrial Product Dept, PDBU Tianma Microelectronics Co., Ltd.		
Signatures	Date	Approved By	Date
_____	_____	XiaoXing Ding	2020/9/10
_____	_____	Reviewed By	
		Longping Deng	2020/9/9
		Prepared By	
		Bin Wang	2020/9/8
Comments:			

* This cover page is for your Comments and Signatures back to TIANMA.

REVISION HISTORY

Rev	Date	Page	Revision Items	Editor
1.0	2020-09-08		Preliminary Specification release.	Bin Wang
1.1	2020-10-23		Update Mechanical Drawing in page 17,add OTP interface	Bin Wang
1.2	2020-11-11		Update the item name in the Mechanical Drawing in page 17.	Bin Wang
1.3	2021-01-28		Complete specification information and perfect format.	Bin Wang
1.4	2021-04-13		Update the power supply voltage min/max Value. Update 19,20 pin open function and Mechanical Drawing.	Bin Wang
2.0	2021-09-01		Final Specification release.	Bin Wang
2.1	2021-09-03		Add circuit diagram and remarks on page 5 Vlvds and note update on page 6 LVDS data format chart update .	Bin Wang
2.2	2022-12-14		Update Mechanical Drawing & Matching connector	Bin Wang
2.3	2022-12-19		Update template	Bin Wang

CONTENTS

1. SUMMARY	1
1.1 General Description	1
1.2 Features	1
2. GENERAL SPECIFICATIONS	2
3. INPUT / OUTPUT TERMINALS	3
3.1 CN1 Pin assignment (LCD Interface).....	3
3.2 CN2 Pin assignment (Back Light).....	4
4. ABSOLUTE MAXIMUM RATINGS	5
5. ELECTRICAL CHARACTERISTICS.....	6
5.1 DC Characteristics for Panel Driving	6
5.2 DC Characteristics for Backlight Driving	7
5.3 Recommended Power ON/OFF Sequence	8
5.4 LCD Module Block Diagram.....	9
6. TIMING CHARACTERISTICS.....	10
6.1 LVDS Interface Timing Characteristics	10
6.2 Data Input Timing Parameter Setting.....	11
6.3 LVDS Input Timing Format.....	11
6.4 LVDS interface AC characteristic	12
7. OPTICAL CHARACTERISTICS.....	13
8. RELIABILITY TEST	16
9. MECHANICAL DRAWING	17
10. PACKING INSTRUCTION	18
11. PRECAUTIONS FOR USE OF LCD MODULES.....	19
11.1 Handling Precautions.....	19
11.2 Storage precautions	19
11.3 Transportation Precautions	19
11.4 Screen saver Precautions.....	19
11.5 Safety Precautions.....	19

1. Summary

1.1 General Description

This is a 8.4 inch a-Si TFT-LCD module with Normal- Black technology. It is composed of a TFT-LCD panel, a driver circuit, FPC, PCB, Bezel, and a LED backlight unit.

1.2 Features

- Ultra-wide viewing angle.
- Wide temperature range.
- Interface: LVDS 6/8 bits.

- Acquisition product for UL62368-1/CSA C22.2 No. 62368.
- Compliant with the European RoHS Directive (2011/65/EU) and Delegated Directive (2015/863/EU, Amending Annex II of 2011/65/EU).

2. General Specifications

	Feature	Spec	Unit
Display Spec	Size	8.4 inches	
	Resolution	1024x768	
	Pixel Pitch	0.1665 x 0.1665	mm
	TFT Active Area	170.496x127.872	mm
	Technology Type	a-Si	
	Pixel Configuration	R.G.B Vertical Stripe	
	Display Mode	SFT, Normally Black	
	Surface Treatment	Anti-Glare	
	Viewing Direction	All Direction	
Mechanical Characteristics	LCM (W x H x D)	199.5x149x9.7	mm
	Weight	301	g
Optical Characteristics	Luminance	Typ:600	cd/m2
	Contrast Ratio	Typ:1000:1	
	NTSC	Typ:70	%
	Viewing Angle	88/88/88/88(SFT)	degree
Electrical Characteristics	Interface	LVDS 6/8 bits	
	Color Depth	16.7 Million color/262 Kilo color	color
	Power Consumption	LCD:1023; Backlight:5340	mW

Table 2.1 General TFT Specifications

3. Input / Output Terminals

3.1 CN1 Pin assignment (LCD Interface)

Connector Information	
Connector	FI-SEB20P-HFE-E3000
Matching connector	FI-SE20ME (JAE)

Table 3.1.1 Connector information

Pin No.	Symbol	I/O	Function	Remark
1	VCC	P	3.3V power supply	-
2	VCC	P	3.3V power supply	-
3	GND	P	Ground	Note2
4	GND	P	Ground	Note2
5	Link0-	I	Negative LVDS differential data input	
6	Link0+	I	Positive LVDS differential data input	
7	GND	P	Ground	Note2
8	Link1-	I	Negative LVDS differential data input	
9	Link1+	I	Positive LVDS differential data input	
10	GND	P	Ground	Note2
11	Link2-	I	Negative LVDS differential data input	
12	Link2+	I	Positive LVDS differential data input	
13	GND	P	Ground	Note2
14	CLKIN-	I	Negative LVDS differential data input	
15	CLKIN+	I	Positive LVDS differential data input	
16	GND	P	Ground	Note2
17	Link3-	I	Negative LVDS differential data input	Note3
18	Link3+	I	Positive LVDS differential data input	Note3
19	MODE	I	6-bit / 8-bit input select for LVDS interface. High : 8bit. Low or Open : 6bit.	Note4
20	SC	I	Reverse Scan control Low or Open: Normal scan High : Reverse scan	Note4 Note5

Table 3.1.2 Pin Assignment for LCD Interface

Note1:I---Input, O---Output, P--- Power/Ground

Note2: All of the GND Pins should be connected to the system ground.

Note3: Please set to GND if pin is NOT in use.

Note4: The circuit of module is shown below.

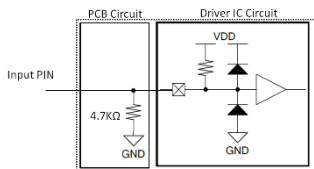

Note5: The function of the SC. The figure below is a front view.

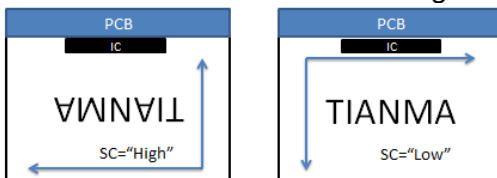

3.2 CN2 Pin assignment (Back Light)

Connector Information	
connector	FI-S6P-HFE-E1500(JAE)
Matching connector	FI-S6S

Table 3.2.1 Connector information

Pin	Symbol	I/O	Description	Remark
1	VL	P	Power Supply Input Voltage	-
2	VL	P	Power Supply Input Voltage	-
3	GND	P	GND	-
4	GND	P	GND	-
5	BLEN	I	Backlight ON-OFF (High : ON, Low : OFF)	-
6	V _{PDIM}	I	Light Dimming Control (PWM)Input Voltage	-

Table 3.2.2 Pin Assignment for Back Light Interface

4. Absolute Maximum Ratings

Item	Symbol	MIN	MAX	Unit	Remark
Power Voltage	VCC	-0.3	5	V	
Input voltage	VIN	-0.3	5	V	Note1
Backlight Power Voltage	VL	-0.3	26.5	V	
Input voltage	VLVDS	-0.3	2	V	Note2
Backlight Input voltage	VBLIN	-0.3	26.5	V	Note3
Operating Temperature	Top	-30	80	°C	-
Storage Temperature	Tst	-40	90	°C	-
Relative Humidity Note2	RH	--	≤95	%	Ta≤40°C
		--	≤85	%	40°C<Ta≤50°C
		--	≤55	%	50°C<Ta≤60°C
		--	≤36	%	60°C<Ta≤70°C
		--	≤24	%	70°C<Ta≤80°C
Absolute Humidity	AH	--	≤70	g/m ³	Ta>70°C

Table 4.1 Absolute Maximum Ratings

Note1: Input voltage include MODE,SC, VCC.

Note2: Including Link0-/+ , Link1-/+ , Link2-/+ , Link3-/+ ,CLKIN+/-

Note3: Backlight Input voltage include BLEN, VPDIM .

Note4: Ta means the ambient temperature.

It is necessary to limit the relative humidity to the specified temperature range.

Condensation on the module is not allowed

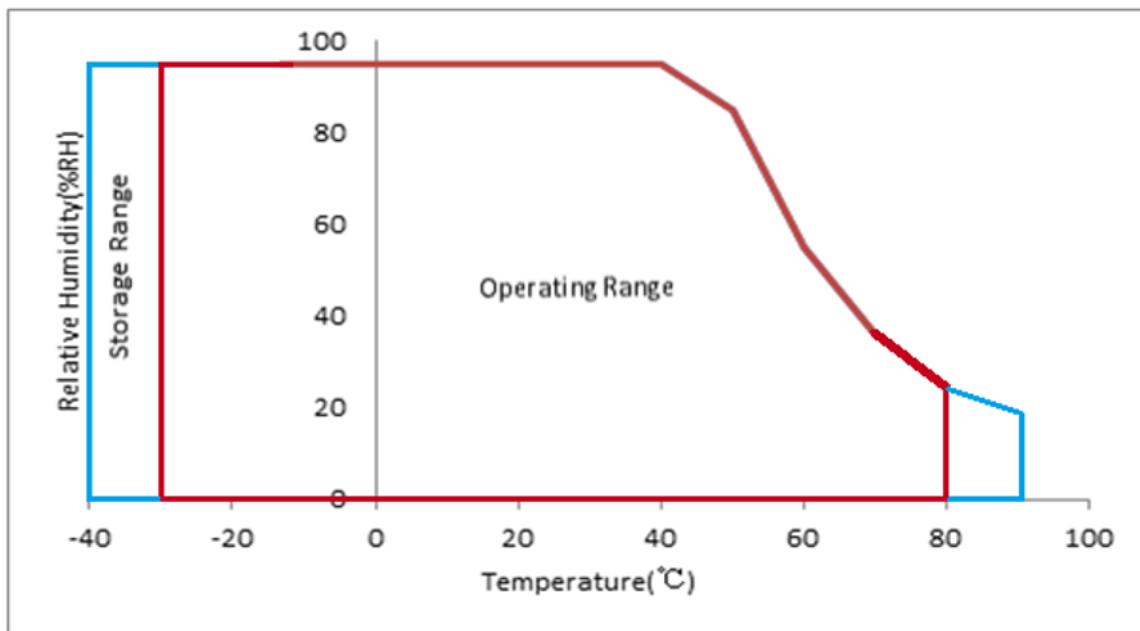

Figure 4.1 Absolute Maximum Ratings chart

5. Electrical Characteristics

5.1 DC Characteristics for Panel Driving

Item	Symbol	MIN	TYP	MAX	Unit	Remark
Power supply voltage	VCC	3.0	3.3	3.6	V	
Power Ground	GND	-	0	-	V	
Input High Voltage	VIH	0.7xVCC		VCC	V	Note1
Input Low Voltage	VIL	GND		0.3xVCC	V	
LVDS differential input high threshold voltage	RxVTH	-	-	+200	mV	Note2
LVDS differential input low threshold voltage	RxVTL	-200	-	-		
Differential input voltage	VID	200	-	600	mV	
Differential input common mode voltage	RxVCM	1.0	1.2	1.7- VID /2	V	
Current of VCC Power supply	IVCC	-	310	-	mA	Note3
Power consumption	P	-	1023	-	mW	
Inrush current of VCC	Irush	-	1.6		A	Note4

Table 5.1.1 Operating Voltages

Note1: Including MODE,SC.

Note2: Refers to the LVDS waveform as shown below:

Note3: Test in white pattern

Note4:VCC rising time >1ms.

Single-end Signal

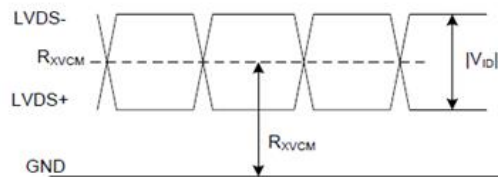

Differential Signal

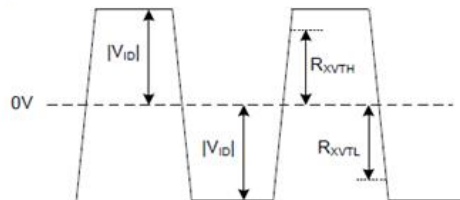

LVDS DC Diagram

Figure 5.1.1 LVDS DC Diagram

5.2 DC Characteristics for Backlight Driving

Parameter	Symbol	min.	typ.	max.	Unit	Remarks
Power supply voltage	VL	10.8	12.0	13.2	V	Note1,Note3
Power supply current	IVL	-	445	-	mA	Note2
Power consumption of Backlight	P	-	5340	-	mW	
Input voltage for V_{PDIM} (PWM) signal	High	V_{IH}	1.3	-	VL	V
	Low	V_{IL}	0	-	0.5	
Input voltage for BLEN signal	High	V_{IH}	1.3	-	VL	
	Low	V_{IL}	0	-	0.5	
V_{PDIM} (PWM) frequency	f_{PWM}	100	-	1000	Hz	
V_{PDIM} (PWM) duty ratio	DR_{PWM}	1	-	100	%	
LED Life time	LT	-	50000	--	Hrs	

Table 5.2.1 LED Backlight Characteristics

Note1: When designing of the power supply, take the measures for the prevention of surge voltage.

Note2: This value excludes peak current such as overshoot current. At the maximum luminance control.

Note3: The power supply lines (VL and GND) may have ripple voltage during luminance control of LED.

There is the possibility that the ripple voltage produces acoustic noise and signal wave noise in audio circuit and so on.

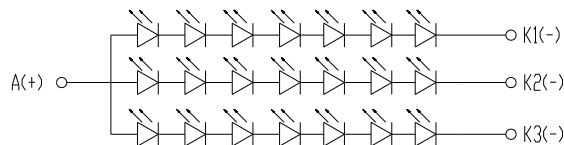

Figure 5.2.1 LED connection of backlight

5.3 Recommended Power ON/OFF Sequence

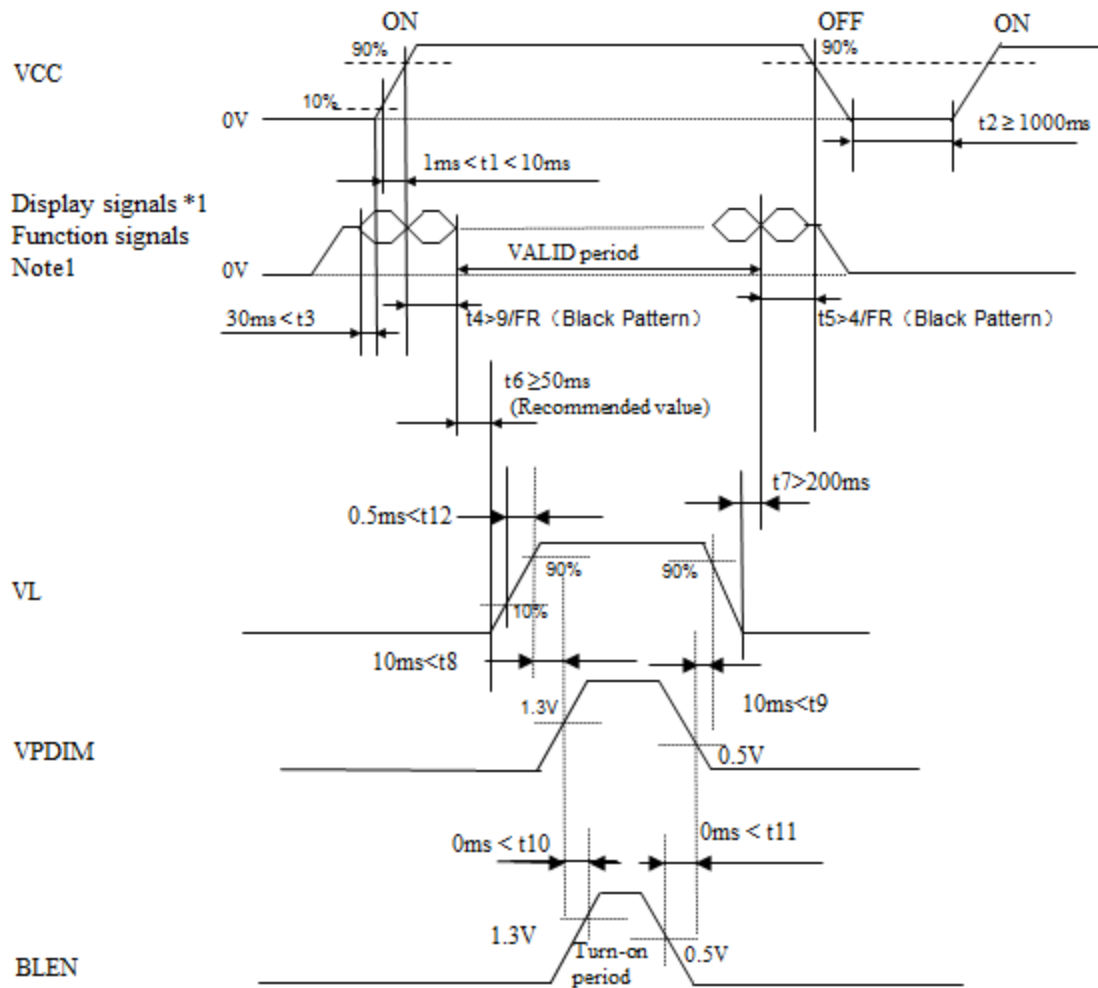

Figure 5.3.1 Power On/off sequence

Note1: If some of display and function signals of this product are cut while this product is working, even if the signal input to it once again, it might not work normally. If a customer stops the display and function signals, VCC also must be shut down.

Note2: The backlight should be turned on within the valid period of display and function signals, in order to avoid unstable data display.

Note3: FR=Frame rate=60Hz.

5.4 LCD Module Block Diagram

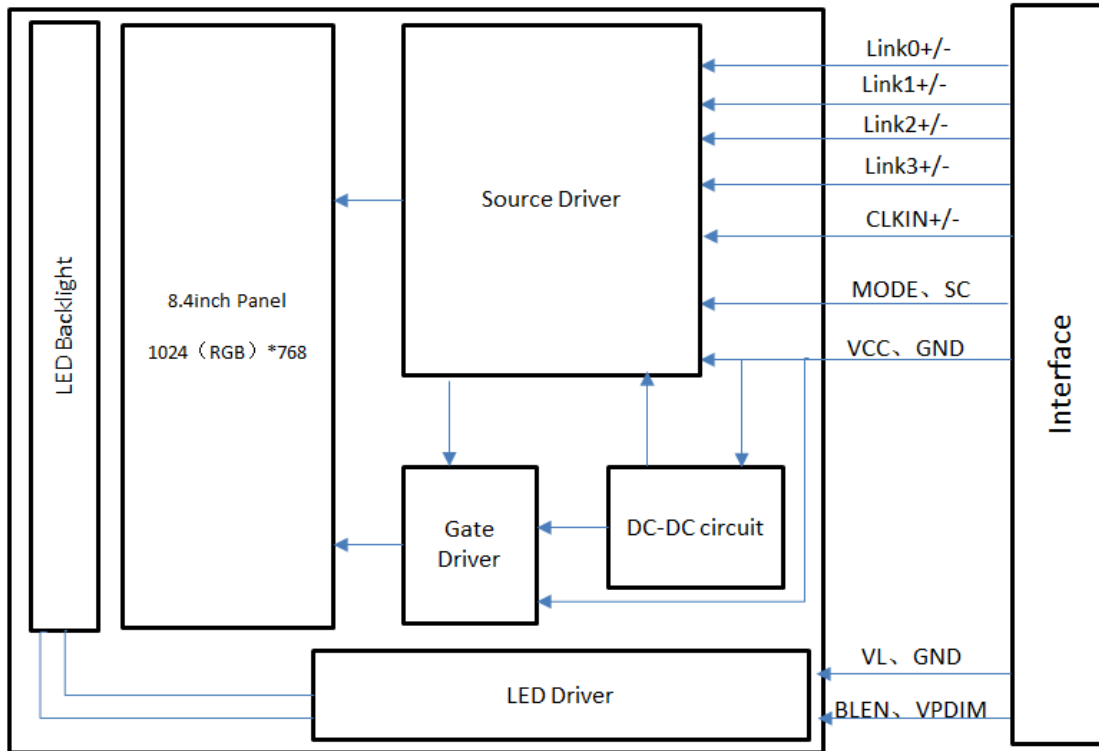

Figure 5.4.1 LCD Module Block Diagram

6. Timing Characteristics

6.1 LVDS Interface Timing Characteristics

LVDS Input Data Format 8-bit LVDS VESA

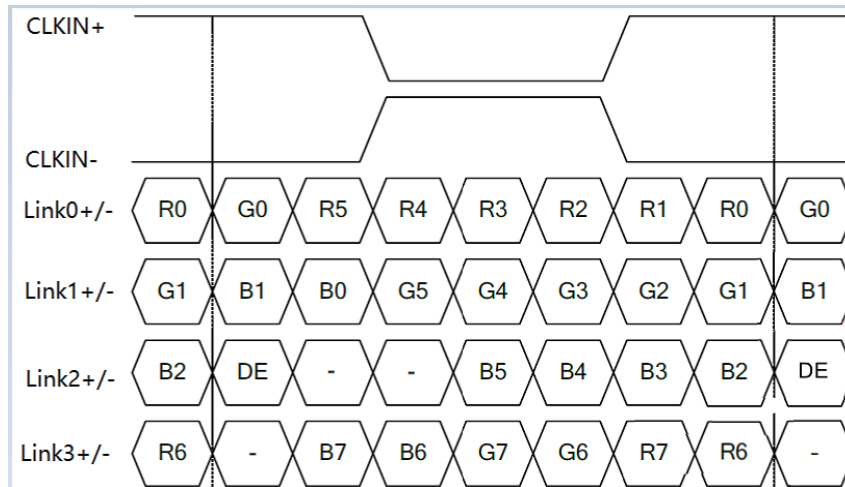

Figure 6.1.1 LVDS data map

LVDS Input Data Format 6-bit LVDS VESA

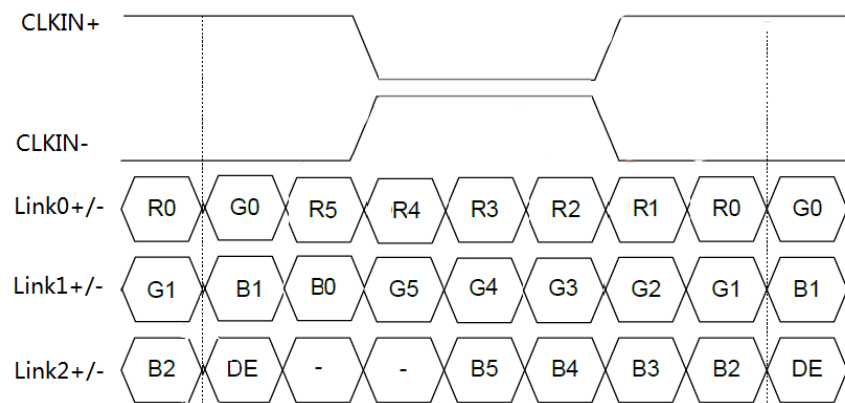

Figure 6.1.2 LVDS Data map

6.2 Data Input Timing Parameter Setting

DE mode for 1024RGBx768

Parameter	Symbol	Min.	Typ.	Max.	Unit
CLKIN+/- frequency	FCLK	50.3	50.7	65.3	MHz
Horizontal display area	THD	1024			CLK
HS period time	TH	1084	1088	1214	CLK
HS blanking	THFP+THBP	60	64	190	CLK
Vertical display area	TVD	768			H
VS period time	TV	774	776	897	H
VS blanking	TVBP+TVFP	6	8	129	H

Table 6.2.1 Data Input Timing Parameters

6.3 LVDS Input Timing Format

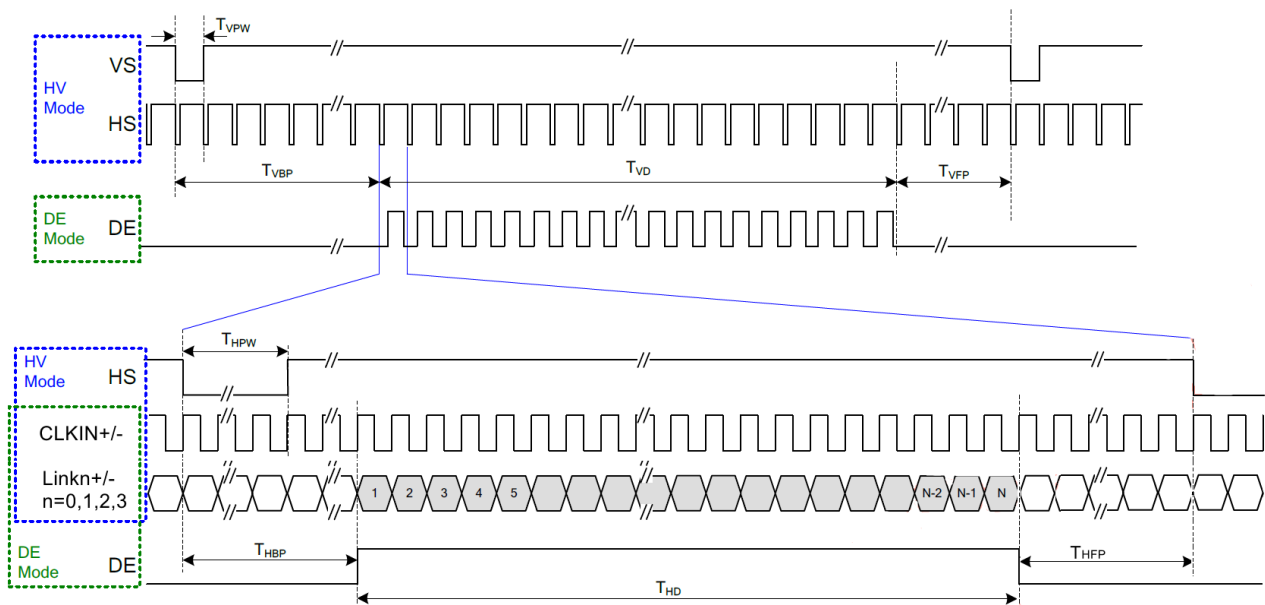

Table 6.3.1 Recommended input timing of LVDS transmitter

Note1: As shown in the figure above, the customer only needs to look at the DE mode section, instead of the SYNC section.

6.4 LVDS interface AC characteristic

Parameter	Symbol	Min.	Typ.	Max.	Unit	Condition
Clock frequency	FLVCLK	25	-	85	MHz	Refer to input timing table for each display resolution.
Clock Period	TLVCLK	11.76	-	40	nsec	
Clock high time	TLVCH	-	4/(7* RXFCLK)	-	ns	
Clock low time	TLVCL	-	3/(7* RXFCLK)	-	ns	
Input data skew margin	TRSKM	-	-	0.25	UI	VCC_IF=1.8V w/o SSC
Strobe width	TSW	0.5	-	-	UI	
1 data bit time	UI	-	1/7	-	TLVCLK	
Position 1	TPOS1	-0.25	0	0.25	UI	
Position 0	TPOS0	0.75	1	1.25	UI	
Position 6	TPOS6	1.75	2	2.25	UI	
Position 5	TPOS5	2.75	3	3.25	UI	
Position 4	TPOS4	3.75	4	4.25	UI	
Position 3	TPOS3	4.75	5	5.25	UI	
Position 2	TPOS2	5.75	6	6.25	UI	

Table 6.4.1 LVDS interface AC characteristic

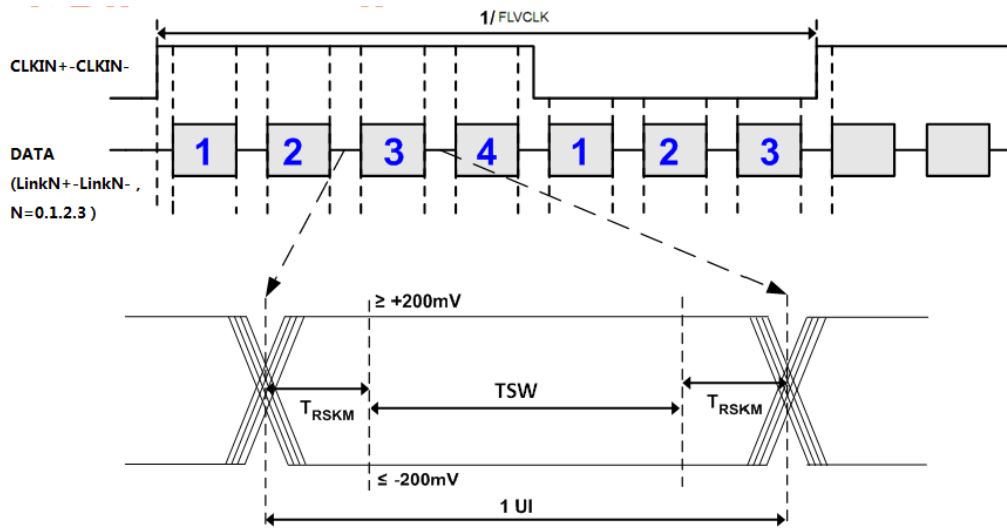

Figure 6.4.1 LVDS Data Skew

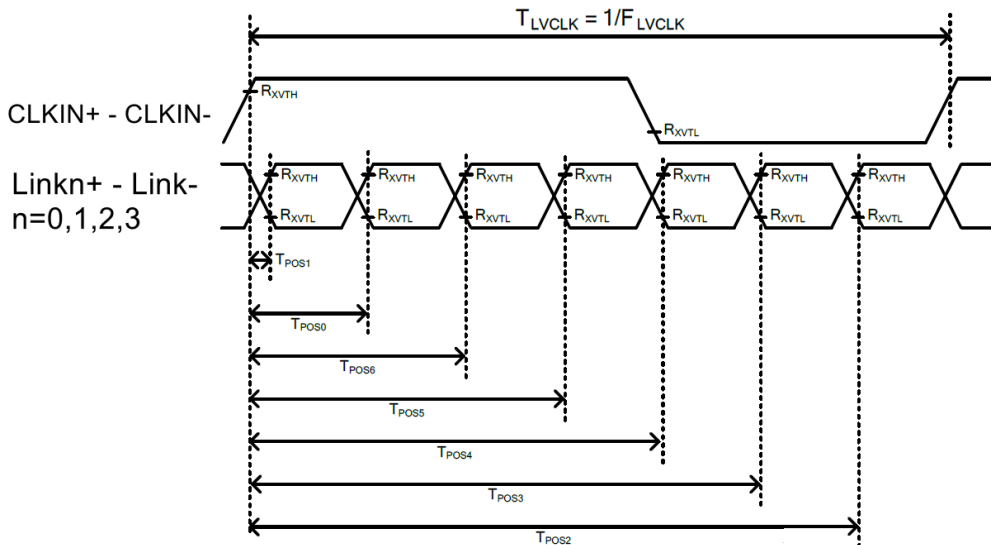

Figure 6.4.2 LVDS input timing

7. Optical Characteristics

Item	Symbol	Condition	Min	Typ	Max	Unit	Remark
View Angles	θT	$CR \geq 10$	80	88	--	Degree	Note2,3
	θB		80	88	--		
	θL		80	88	--		
	θR		80	88	--		
Contrast Ratio	CR	$\theta = 0^\circ$	800	1000	--		Note 3
Response Time	T_{ON}	25°C	--	25	30	ms	Note 4
	T_{OFF}						
Chromaticity	White	Backlight is on	x	0.239	0.289	0.339	Note 1,5
			y	0.258	0.308	0.358	
	Red		x	0.580	0.630	0.680	Note 1,5
			y	0.281	0.331	0.381	
	Green		x	0.252	0.302	0.352	Note 1,5
			y	0.575	0.625	0.675	
	Blue		x	0.103	0.153	0.203	Note 1,5
			y	0.012	0.062	0.112	
Luminance Uniformity	U		75	85		%	Note 6
NTSC			65	70	--	%	Note 5
Luminance	L		500	600		cd/m ²	Note 7

Table 7.1 Optical Parameters

Test Conditions:

1. IF= 70 mA/LED, and the ambient temperature is 25°C.
2. The test systems refer to Note1 and Note2.

Note1: Definition of optical measurement system.

The optical characteristics should be measured in dark room. After 5 Minutes operation, the optical characteristics are measured at the center point of the LCD screen.

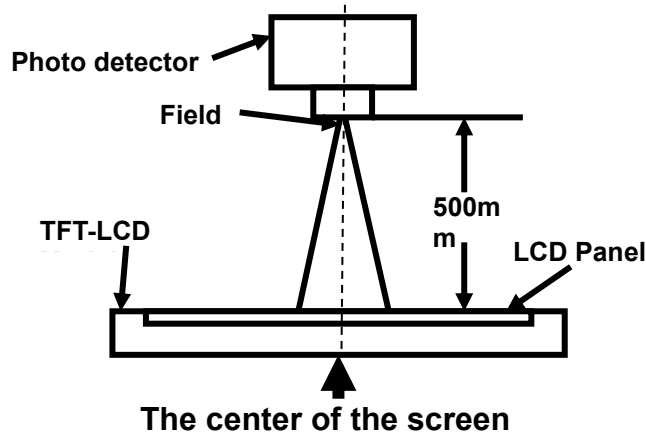

Fig1. Measurement Set Up

Note2: Definition of viewing angle range and measurement system. Viewing angle is measured at the center point of the LCD .

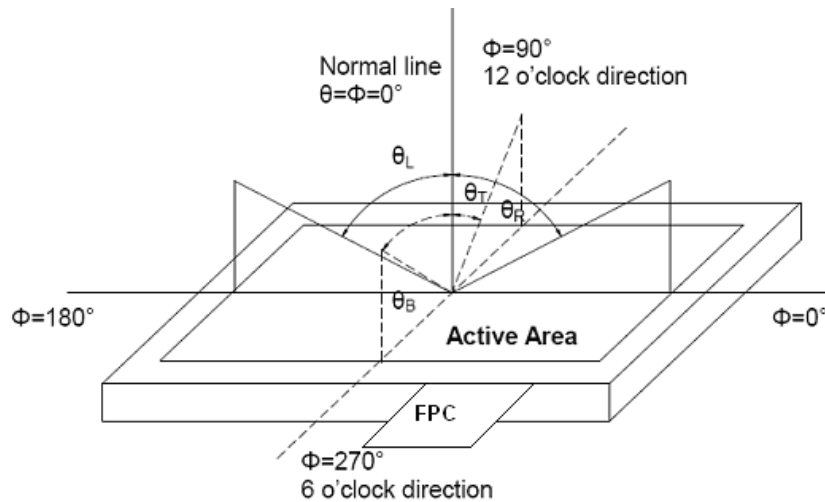

Fig2. Measurement viewing angle

Note3: Definition of contrast ratio

$$\text{Contrast ratio (CR)} = \frac{\text{Luminance measured when LCD is on the "White" state}}{\text{Luminance measured when LCD is on the "Black" state}}$$

Note4: Definition of Response time

For SFT LCM, the response time is defined as the LCD optical switching time interval between “White” state and “Black” state. Rise time (T_r) is the time between photo detector output intensity changed from 10% to 90%. And fall time (T_f) is the time between photo detector output intensity changed from 90% to 10%.

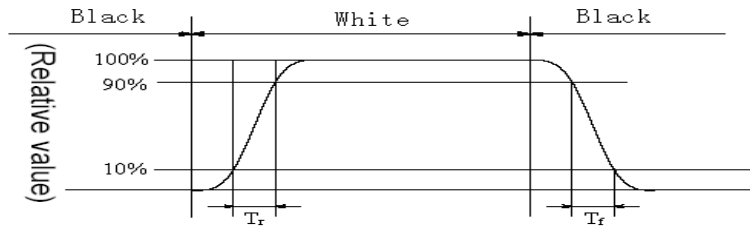

Fig3. Response Time Testing(SFT)

Note5: Definition of color chromaticity (CIE1931)

Color coordinates measured at center point of LCD.

Note6: Definition of Luminance Uniformity

Active area is divided into 9 measuring areas (Refer Fig.5). Every measuring point is placed at the center of each measuring area.

$$\text{Luminance Uniformity (U)} = \text{Lmin} / \text{Lmax}$$

Lmax: The measured Maximum luminance of all measurement position.

Lmin: The measured Minimum luminance of all measurement position.

L-----Active area length; W----- Active area width

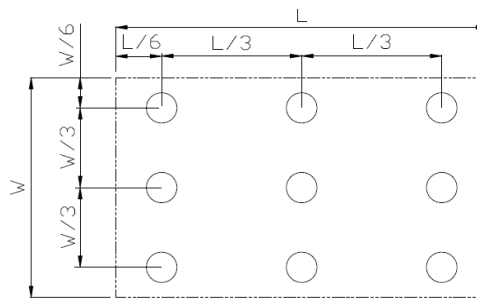

Fig4. Luminance Uniformity Measurement Locations(9 points)

Note7: Definition of Luminance:

Measure the luminance of white state at center point.

8. Reliability Test

No	Test Item	Condition	Remarks
1	High Temperature Operation	Ta = +80°C, 500 hours	IEC60068-2-1 GB2423.2
2	Low Temperature Operation	Ta = -30°C, 500 hours	IEC60068-2-1 GB2423.1
3	High Temperature Storage	Ta = +90°C, 500 hours	IEC60068-2-1 GB2423.2
4	Low Temperature Storage	Ta = -40°C, 500 hours	IEC60068-2-1 GB2423.1
5	Storage at High Temperature and Humidity	Ta = +60°C, 90% RH max, 500 hours	IEC60068-2-78 GB/T2423.3
6	Thermal Shock (non-operation)	-30°C 30 min~+80°C 30 min, Change time: 5min, 100 Cycle	Start with cold temperature, End with high temperature, IEC60068-2-14, GB2423.22
7	ESD	C=150pF, R=330Ω, 5point/panel Air: ±15Kv, 5times; Contact: ±8Kv, 5times (Environment: 15°C~35°C, 30%~60%. 86Kpa~106Kpa)	IEC61000-4-2 GB/T17626.2
8	Vibration Test (Non Op)	5~100HZ, 19.60m/s ² 1min/cycle 120times Per X\Y\Z	IEC60068-2-6 GB/T17626.6
9	Mechanical Shock (Non Op)	539m/s ² , 11ms 5times ±X、±Y、±Z	IEC60068-2-27 GB/T2423.5

Table 8.1 RA test condition

Note1: Ts is the temperature of panel's surface.

Note2: Ta is the ambient temperature of sample.

Note3: Before cosmetic and function test, the product must have enough recovery time, at least 24 hours at room temperature.

Note 4: In the standard condition, there shall be no practical problem that may affect the display function. After the reliability test, only guarantee the operation of the product, but don't guarantee all of the cosmetic specification.

9. Mechanical Drawing

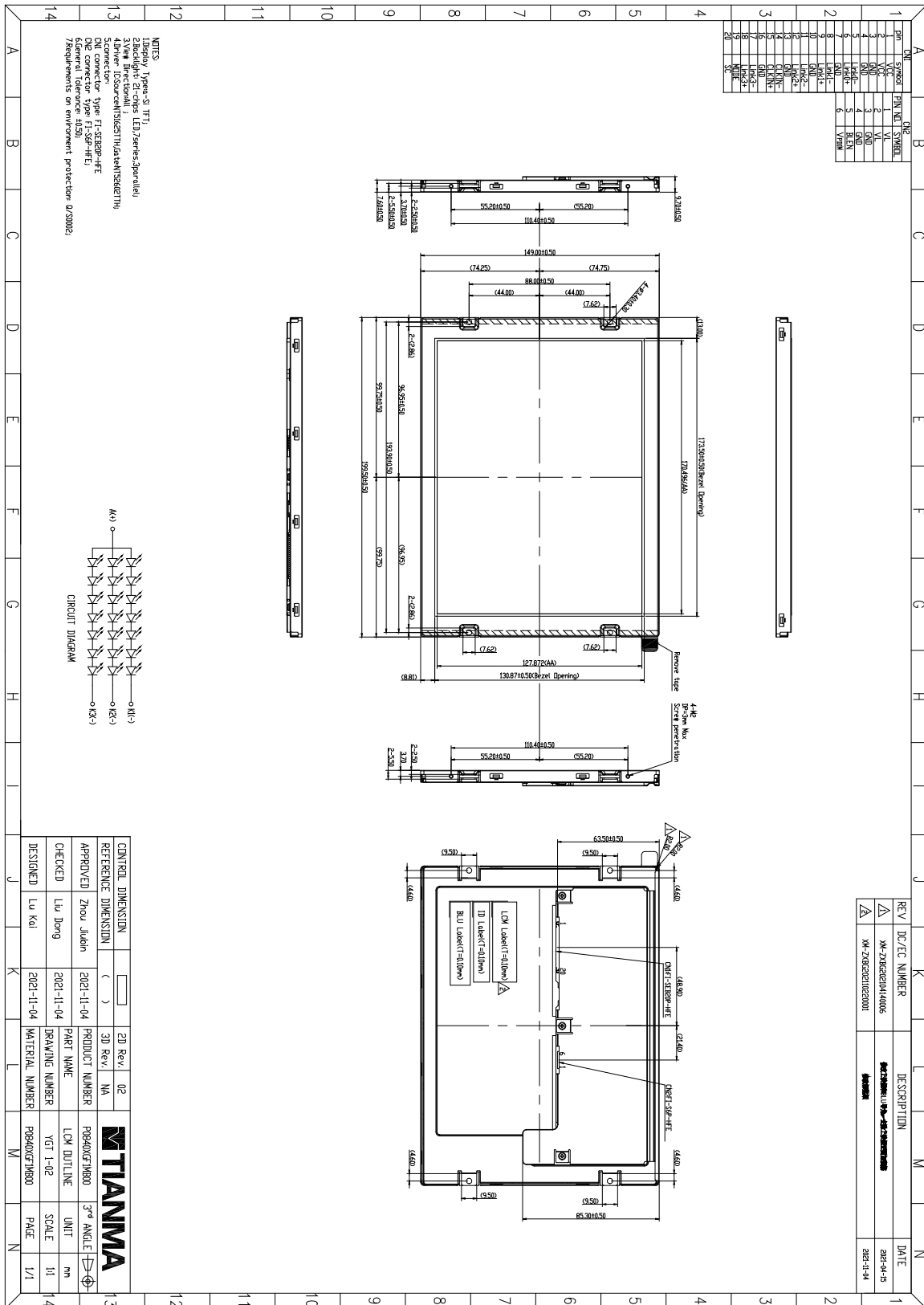
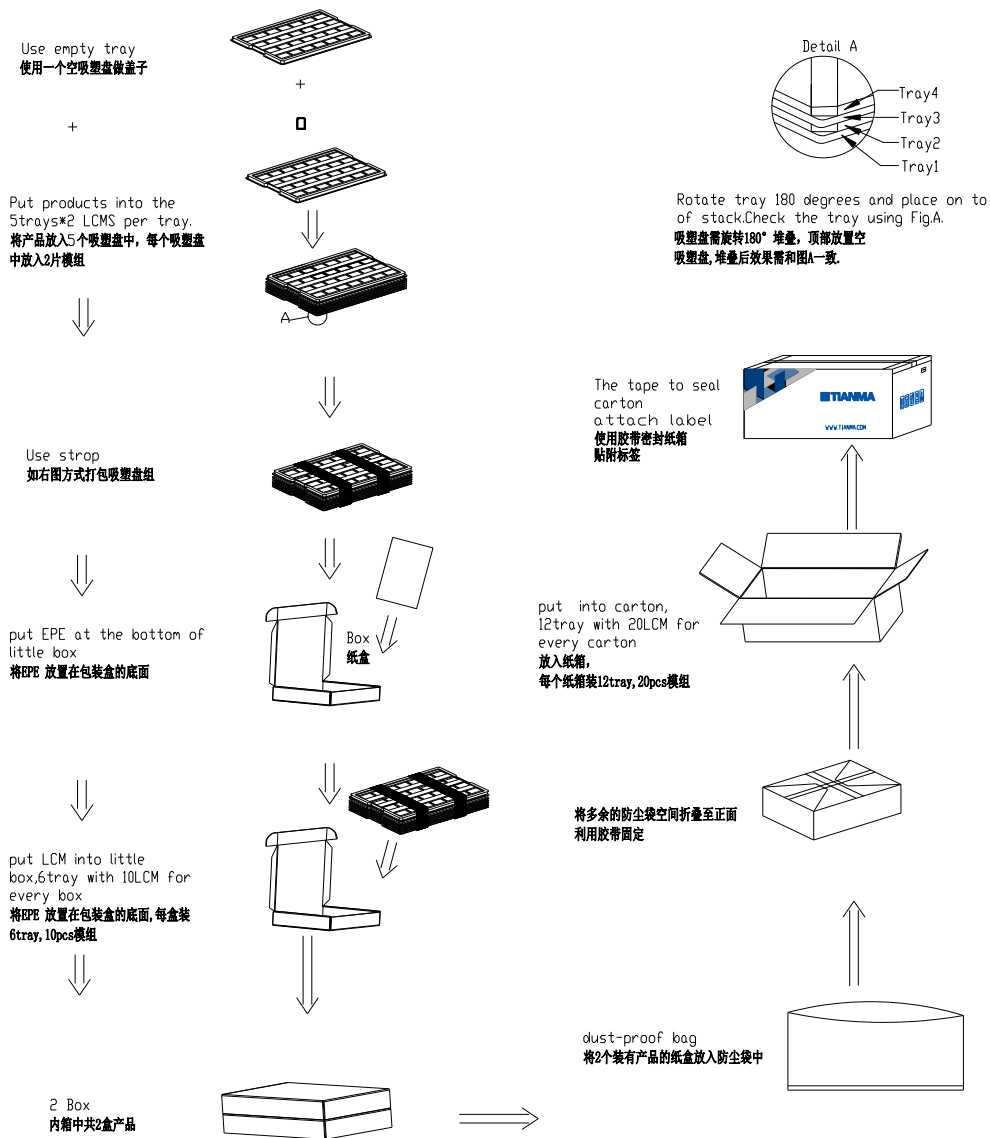

Figure 9.1 Mechanical Drawing

10. Packing Instruction

No	Item	Model (Material)	Dimensions(mm)	Unit Weight(Kg)	Quantity	Remark	
1	LCM module	P0840XGF1MB00	199.5×149×9.7	0.301	20		
2	Tray	PET	485×330×25	0.257	12		
3	Dust-proof Bag	PE	700×545×0.05	0.021	1		
4	Carton	Corrugated Paper	544×365×250	1.01	1		
5	BOX	Corrugated Paper	520×345×111	0.38	2		
6	Label		100×52	0.001	1		
7	EPE	EPE	485×330×5	0.016	2		
8	Total weight	10.95Kg±5%					



11. Precautions for Use of LCD Modules

11.1 Handling Precautions

- (1) The display panel is made of glass. Do not subject it to mechanical shock by dropping it, etc.
- (2) If the display panel is damaged and the liquid crystal fluid inside it leaks out be sure not to get any in your mouth. If the fluid comes into contact with your skin or clothes promptly wash it off using soap and water.
- (3) Do not apply excessive force to the display surface or the bezel since this may cause the color tone to vary.
- (4) The polarizer covering the display surface of the LCD module is soft and easily scratched. Handle the polarizer carefully.
- (5) If the display surface is contaminated, breathe on the surface and gently wipe it with a soft dry cloth. If it is still not completely clear use a moist cloth with one of the following solvents:
 - Isopropyl alcohol
 - Ethyl alcoholSolvents other than those mentioned above may damage the polarizer. Specifically, do not use the following:
 - Water
 - Ketone
 - Aromatic solvents
- (6) Do not disassemble the LCD Module.
- (7) If powered off, do not apply the input signals.
- (8) To prevent destruction of the module by static electricity, be careful to maintain an optimum work environment.
- (9) Be sure to ground your body when handling the LCD Modules.
- (10) Tools used for assembly, must be properly grounded.
- (11) To reduce the amount of static electricity generated, do not conduct assembly or other work under very low humidity conditions.
- (12) The LCD Module is covered with a film to protect the display surface, remove film slowly under the ionizer.

11.2 Storage precautions

- (1) When storing the LCD modules avoid exposure to direct sunlight or to the light of fluorescent lamps.
- (2) The LCD modules should be stored within the rated storage temperature range. The recommend condition is: Temperature: 0 ~ 35 °C at normal humidity.
- (3) The LCD modules should be stored in a room without acid, alkali or other harmful gas.

11.3 Transportation Precautions

The LCD modules should not be dropped or subject to violent mechanical shock during transportation. Also they should avoid excessive pressure, water, high humidity and direct sunlight.

11.4 Screen saver Precautions

Not display the fixed pattern for a long time. Use a screen saver, if the fixed pattern is displayed on the screen

11.5 Safety Precautions

- (1) When you waste damaged or unnecessary LCDs, it is recommended to crush LCDs into pieces and wash them off with solvents such as acetone and ethanol, which should later be burned
- (2) Be sure to turn off the power supply when inserting or disconnecting the LED backlight cable.
- (3) LED driver should be designed to limit or stop its function when over current is detected on the LED.

Our company network supports you worldwide with offices in Germany, Austria, Switzerland, the UK and the USA. For more information please contact:

Headquarters

Germany



FORTEC Elektronik AG

Augsburger Str. 2b
82110 Germering

Phone: +49 89 894450-0
E-Mail: info@fortecag.de
Internet: www.fortecag.de

Fortec Group Members

Austria



Distec GmbH Office Vienna

Nuschinggasse 12
1230 Wien

Phone: +43 1 8673492-0
E-Mail: info@distec.de
Internet: www.distec.de

Germany



Distec GmbH

Augsburger Str. 2b
82110 Germering

Phone: +49 89 894363-0
E-Mail: info@distec.de
Internet: www.distec.de

Switzerland



ALTRAC AG

Bahnhofstraße 3
5436 Würenlos

Phone: +41 44 7446111
E-Mail: info@altrac.ch
Internet: www.altrac.ch

United Kingdom



Display Technology Ltd.

Osprey House, 1 Osprey Court
Hichingbrooke Business Park
Huntingdon, Cambridgeshire, PE29 6FN

Phone: +44 1480 411600
E-Mail: info@displaytechnology.co.uk
Internet: www.displaytechnology.co.uk

USA



Apollo Display Technologies, Corp.

87 Raynor Avenue,
Unit 1 Ronkonkoma,
NY 11779

Phone: +1 631 5804360
E-Mail: info@apolloDisplays.com
Internet: www.apolloDisplays.com