



OUR GLOBAL
COMPETENCE
CENTRES

 APOLLO DISPLAY
TECHNOLOGIES



 DISTEC



 DISPLAY
TECHNOLOGY



Datasheet

Tianma

NL10276BC30-39

15" TFT Display

NL-60-089

The information contained in this document has been carefully researched and is, to the best of our knowledge, accurate. However, we assume no liability for any product failures or damages, immediate or consequential, resulting from the use of the information provided herein. Our products are not intended for use in systems in which failures of product could result in personal injury. All trademarks mentioned herein are property of their respective owners. All specifications are subject to change without notice.

NLT Technologies, Ltd.

TFT COLOR LCD MODULE

NL10276BC30-39

38cm (15.0 Type)

XGA

LVDS interface (1port)

DATA SHEET

DOD-PP-1612 (2nd edition)



**This DATA SHEET is updated document from
DATA SHEET DOD-PP-1397(1).**

**All information is subject to change without notice.
Please confirm the sales representative before
starting to design your system.**

INTRODUCTION

The Copyright to this document belongs to NLT Technologies, Ltd. (hereinafter called "NLT"). No part of this document will be used, reproduced or copied without prior written consent of NLT.

NLT does and will not assume any liability for infringement of patents, copyrights or other intellectual property rights of any third party arising out of or in connection with application of the products described herein except for that directly attributable to mechanisms and workmanship thereof. No license, express or implied, is granted under any patent, copyright or other intellectual property right of NLT.

Some electronic products would fail or malfunction at a certain rate. In spite of every effort to enhance reliability of products by NLT, the possibility of failures and malfunction might not be avoided entirely. To prevent the risks of damage to death, human bodily injury or other property arising out thereof or in connection therewith, each customer is required to take sufficient measures in its safety designs and plans including, but not limited to, redundant system, fire-containment and anti-failure.

The products are classified into three grades: "**Standard**", "**Special**", and "**Specific**".

Each quality grade is designed for applications described below. Any customer who intends to use a product for application other than that of Standard is required to contact an NLT sales representative in advance.

The **Standard**: Applications as any failure, malfunction or error of the products are free from any damage to death, human bodily injury or other property (Products Safety Issue) and not related the safety of the public (Social Issues), like general electric devices.

Examples: Office equipment, audio and visual equipment, communication equipment, test and measurement equipment, personal electronic equipment, home electronic appliances, car navigation system (with no vehicle control functions), seat entertainment monitor for vehicles and airplanes, fish finder (except marine radar integrated type), PDA, etc.

The **Special**: Applications as any failure, malfunction or error of the products might directly cause any damage to death, human bodily injury or other property (Products Safety Issue) and the safety of the public (Social Issues) and required high level reliability by conventional wisdom.

Examples: Vehicle/train/ship control system, traffic signals system, traffic information control system, air traffic control system, surgery/operation equipment monitor, disaster/crime prevention system, etc.

The **Specific**: Applications as any failure, malfunction or error of the products might severe cause any damage to death, human bodily injury or other property (Products Safety Issue) and the safety of the public (Social Issues) and developed, designed and manufactured in accordance with the standards or quality assurance program designated by the customer who requires extremely high level reliability and quality.

Examples: Aerospace system (except seat entertainment monitor), nuclear control system, life support system, etc.

The quality grade of this product is the "**Standard**" unless otherwise specified in this document.

CONTENTS

INTRODUCTION 2

1. OUTLINE 4

 1.1 STRUCTURE AND PRINCIPLE 4

 1.2 APPLICATION 4

 1.3 FEATURES 4

2. GENERAL SPECIFICATIONS 5

3. BLOCK DIAGRAM 6

4. DETAILED SPECIFICATIONS 8

 4.1 MECHANICAL SPECIFICATIONS 8

 4.2 ABSOLUTE MAXIMUM RATINGS 8

 4.3 ELECTRICAL CHARACTERISTICS 9

 4.3.1 LCD panel signal processing board 9

 4.3.2 Backlight lamp 10

 4.3.3 Power supply voltage ripple 11

 4.3.4 Fuse 11

 4.4 POWER SUPPLY VOLTAGE SEQUENCE 12

 4.4.1 LCD panel signal processing board 12

 4.4.2 LED driver board 12

 4.5 CONNECTIONS AND FUNCTIONS FOR INTERFACE PINS 13

 4.5.1 LCD panel signal processing board 13

 4.5.2 Backlight lamp 14

 4.5.3 Positions of plug and socket 14

 4.5.4 Connection between receiver and transmitter for LVDS 15

 4.6 DISPLAY COLORS AND INPUT DATA SIGNALS 17

 4.7 DISPLAY POSITIONS 18

 4.8 SCANNING DIRECTIONS 18

 4.9 INPUT SIGNAL TIMINGS 19

 4.9.1 Outline of input signal timings 19

 4.9.2 Timing characteristics 20

 4.9.3 Input signal timing chart 21

 4.10 OPTICS 22

 4.10.1 Optical characteristics 22

 4.10.2 Definition of contrast ratio 23

 4.10.3 Definition of luminance uniformity 23

 4.10.4 Definition of response times 23

 4.10.5 Definition of viewing angles 23

5. ESTIMATED LUMINANCE LIFETIME 24

6. RELIABILITY TESTS 25

7. PRECAUTIONS 26

 7.1 MEANING OF CAUTION SIGNS 26

 7.2 CAUTIONS 26

 7.3 ATTENTIONS 26

 7.3.1 Handling of the product 26

 7.3.2 Environment 27

 7.3.3 Characteristics 27

 7.3.4 Others 27

8. OUTLINE DRAWINGS 28

 8.1 FRONT VIEW 28

 8.2 REAR VIEW 29

1. OUTLINE

1.1 STRUCTURE AND PRINCIPLE

Color LCD module NL10276BC30-39 is composed of the amorphous silicon thin film transistor liquid crystal display (a-Si TFT LCD) panel structure with driver LSIs for driving the TFT (Thin Film Transistor) array and a backlight.

The a-Si TFT LCD panel structure is injected liquid crystal material into a narrow gap between the TFT array glass substrate and a color-filter glass substrate.

Color (Red, Green, Blue) data signals from a host system (e.g. signal generator, etc.) are modulated into best form for active matrix system by a signal processing board, and sent to the driver LSIs which drive the individual TFT arrays.

The TFT array as an electro-optical switch regulates the amount of transmitted light from the backlight assembly, when it is controlled by data signals. Color images are created by regulating the amount of transmitted light through the TFT array of red, green and blue dots.

1.2 APPLICATION

- For industrial use

1.3 FEATURES

- Ultra-wide viewing angle (Adoption of Ultra-Advanced Super Fine TFT (UA-SFT))
- Long life LED backlight type
- High contrast
- Wide color gamut
- LVDS interface
- Selectable LVDS input map
- Small foot print
- Replaceable lamp for backlight
- Acquisition product for UL60950-1 /CSA C22.2 No.60950-1-03 (File number: E170632)
- Compliant with the European RoHS directive (2002/95/EC)

2. GENERAL SPECIFICATIONS

Display area	304.128 (H) × 228.096 (V) mm	
Diagonal size of display	38cm (15.0 inches)	
Drive system	a-Si TFT active matrix	
Display color	16,777,216 colors (6bit+FRC)	
Pixel	1,024 (H) × 768 (V) pixels	
Pixel arrangement	RGB (Red dot, Green dot, Blue dot) vertical stripe	
Dot pitch	0.099 (H) × 0.297 (V) mm	
Pixel pitch	0.297 (H) × 0.297 (V) mm	
Module size	326.5 (W) × 253.5 (H) × 11.7 (D) mm (typ.)	
Weight	970g (typ.)	
Contrast ratio	900:1 (typ.)	
Viewing angle	<i>At the contrast ratio ≥ 10:1</i> <ul style="list-style-type: none"> • Horizontal: Right side 88° (typ.), Left side 88° (typ.) • Vertical: Up side 88° (typ.), Down side 88° (typ.) 	
Designed viewing direction	Viewing angle with optimum grayscale ($\gamma=2.2$): Normal axis (perpendicular)	
Polarizer surface	Antiglare	
Polarizer pencil-hardness	3H (min.) [by JIS K5600]	
Color gamut	<i>At LCD panel center</i> 72% (typ.) [against NTSC color space]	
Response time	<i>Ton+Toff (10%←→90%)</i> 25ms (typ.)	
Luminance	Luminance 1	330cd/m ² (typ.), <i>At IL= 50mA /One circuit</i>
	Luminance 2	350cd/m ² (typ.), <i>At IL= 55mA /One circuit</i>
Signal system	LVDS 1port (Receiver: Equivalent of THC63LVDF84B, THine Electronics Inc.) [8-bit digital signals for data of RGB colors, Dot clock (CLK), Data enable (DE)]	
Power supply voltage	LCD panel signal processing board: 3.3V	
Backlight	LED Backlight type: Replaceable part <ul style="list-style-type: none"> • Lamp holder set: Type No.: 150LHS38 Recommended LED driver board (Option) <ul style="list-style-type: none"> • LED driver board Luminance 1: Type No.: 150PW02F Luminance 2: user • Corresponding wiring harness Luminance 1: Type No.: 150CBL02 Luminance 2: user 	
Power consumption	Luminance 1	<i>At IL= 50mA /One circuit, Checkered flag pattern,</i> 9.8W (typ.)
	Luminance 2	<i>At IL= 55mA /One circuit, Checkered flag pattern,</i> 10.7W (typ.)

☆

☆

3. BLOCK DIAGRAM

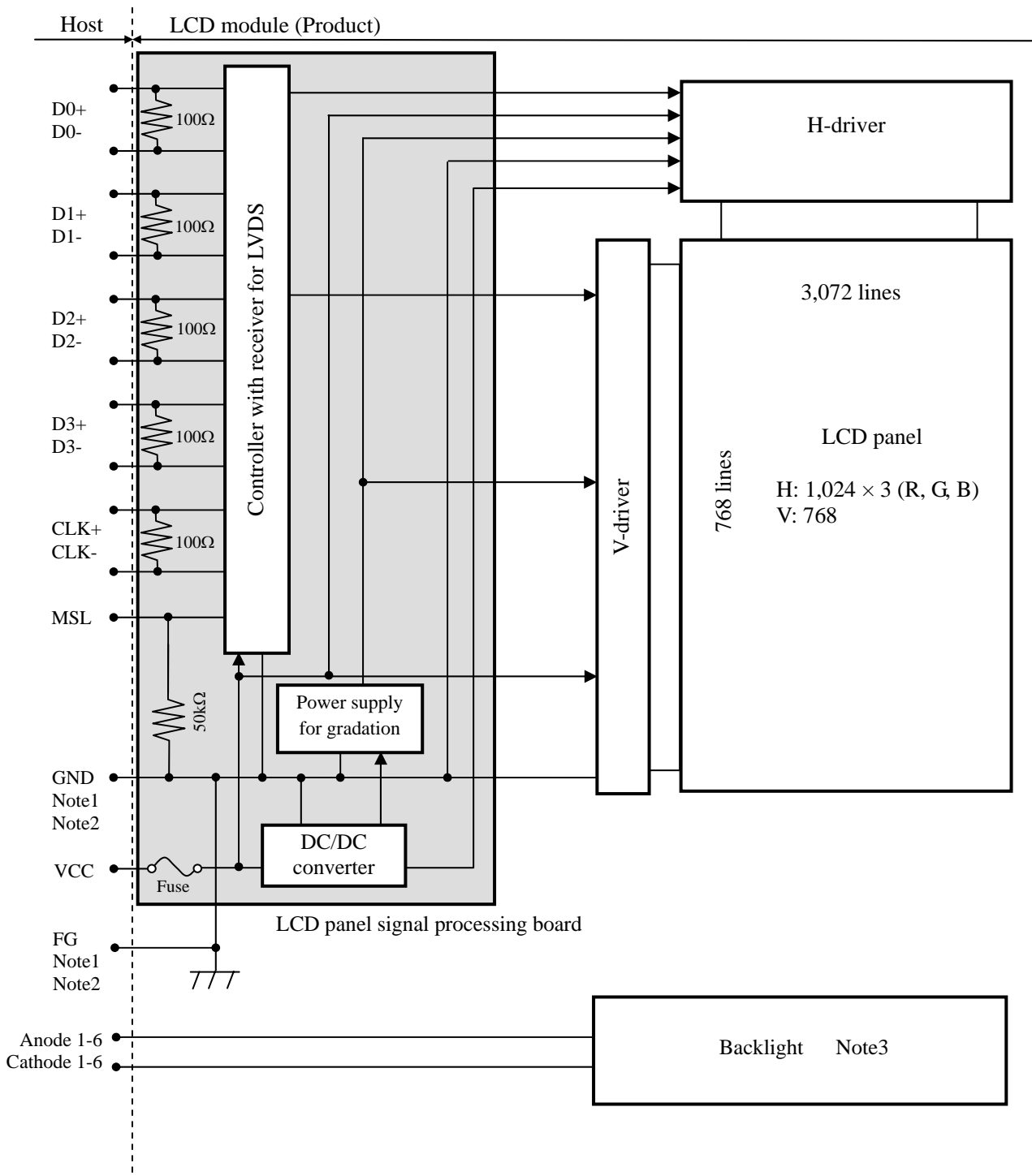

Note1: Relations between GND (Signal ground), FG (Frame ground) in the LCD module is as follows.

GND - FG	Connected
----------	-----------

Note2: GND and FG must be connected to customer equipment's ground, and it is recommended that these grounds be connected together in customer equipment.

Note3: Detail of backlight

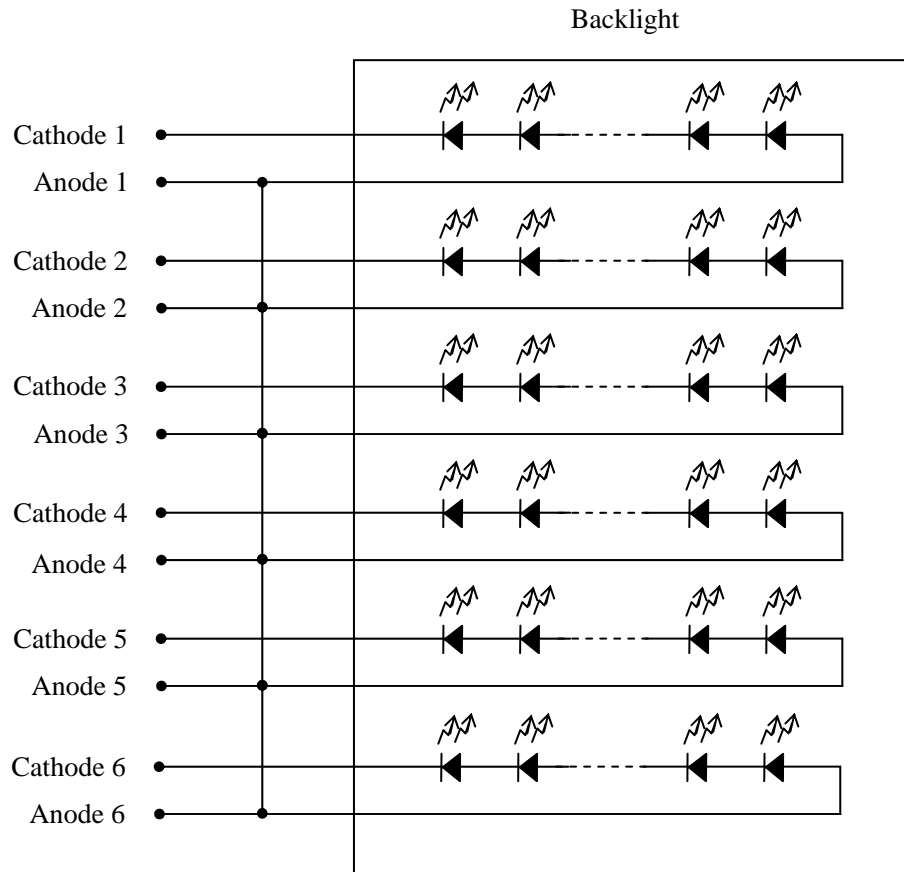

4. DETAILED SPECIFICATIONS

4.1 MECHANICAL SPECIFICATIONS

Parameter	Specification	Unit
Module size	326.5 ± 0.5 (W) × 253.5 ± 0.5 (H) × 11.7 ± 0.5 (D) Note1	mm
Display area	304.128 (H) × 228.096 (V) Note1	mm
Weight	970 (typ.), 1,050 (max.)	g

Note1: See "8. OUTLINE DRAWINGS".

4.2 ABSOLUTE MAXIMUM RATINGS

Parameter		Symbol	Rating	Unit	Remarks	
Power supply voltage	LCD panel signal processing board	VCC	-0.3 to +4.0	V		
Input voltage for signals	Display signals Note1	VD	-0.3 to VCC +0.3	V	-	
	Function signal Note2	VF				
Backlight	Luminance 1	Forward current	IL	60	per one circuit	
	Luminance 2			65		
Storage temperature		Tst	-20 to +80	°C	-	
Operating temperature	Luminance 1	Front surface	TopF	-20 to +70	°C	Note3
		Rear surface	TopR	-20 to +70	°C	Note4
	Luminance 2	Front surface	TopF	-20 to +60	°C	Note5
		Rear surface	TopR	-20 to +60	°C	Note6
Relative humidity Note7		RH	≤ 95	%	Ta ≤ 40°C	
			≤ 85	%	40°C < Ta ≤ 50°C	
			≤ 55	%	50°C < Ta ≤ 60°C	
			≤ 36	%	60°C < Ta ≤ 70°C	
Absolute humidity Note7		AH	≤ 70 Note8	g/m ³	Ta > 70°C	
Operating altitude		-	≤ 4,850	m	-20°C ≤ Ta ≤ 70°C	
Storage altitude		-	≤ 13,600	m	-20°C ≤ Ta ≤ 80°C	

Note1: D0+/-, D1+/-, D2+/-, D3+/- and CLK+/-

Note2: MSL

Note3: Measured at center of LCD panel surface (including self-heat)

Note4: Measured at center of LCD module's rear shield surface (including self-heat)

Note5: Measured at center of LCD panel surface (including self-heat)

Note6: Measured at center of LCD module's rear shield surface (including self-heat)

Note7: No condensation

Note8: Water amount at Ta= 70°C and RH= 36%

4.3 ELECTRICAL CHARACTERISTICS

4.3.1 LCD panel signal processing board

(Ta= 25°C)

Parameter	Symbol	min.	typ.	max.	Unit	Remarks	
Power supply voltage	VCC	3.0	3.3	3.6	V	-	
Power supply current	ICC	-	500 Note1	700 Note2	mA	at VCC= 3.3V	
Permissible ripple voltage	VRP	-	-	100	mVp-p	for VCC	
Differential input threshold voltage for LVDS receiver	High	VTH	-	-	+100	mV	at VCM= 1.2V Note3
	Low	VTL	-100	-	-	mV	
Input voltage swing for LVDS receiver	Vi	0	-	2.4	V	-	
Terminating resistance	RT	-	100	-	Ω	-	
Input voltage for MSL signal	High	VFH	2.0	-	VCC	V	-
	Low	VFL	0	-	0.8	V	
Input current for MSL signal	High	IFH	-	-	300	μA	-
	Low	IFL	-300	-	-	μA	

Note1: Checkered flag pattern [by EIAJ ED-2522]

Note2: Pattern for maximum current

Note3: Common mode voltage for LVDS receiver

4.3.2 Backlight lamp

1. Luminance 1: 330 cd/m² (typ.)

(Ta= 25°C, Note1, Note2, Note3, Note4)

Parameter	Symbol	min.	typ.	max.	Unit	Remarks
Forward current	IL	-	50	55	mA	-
Forward voltage	VL	23.9	27.0	30.6	V	Ta= +25°C at IL= 50mA/ One circuit
		21.1	-	-	V	Ta= +70°C at IL= 50mA/ One circuit
		-	-	33.0	V	Ta= -20°C at IL= 50mA/ One circuit
		-	-	33.3	V	Ta= -20°C at IL= 55mA/ One circuit

2. Luminance 2: 350 cd/m² (typ.)

(Ta= 25°C, Note1, Note2, Note3, Note4)



Parameter	Symbol	min.	typ.	max.	Unit	Remarks
Forward current	IL	-	55	60	mA	-
Forward voltage	VL	24.1	27.3	29.1	V	Ta= +25°C at IL= 55mA/ One circuit
		22.4	-	-	V	Ta= +60°C at IL= 55mA/ One circuit
		-	-	30.8	V	Ta= -20°C at IL= 55mA/ One circuit
		-	-	31.3	V	Ta= -20°C at IL= 60mA/ One circuit

Note1: Please drive with constant current.

Note2: The above specifications are for one LED circuit of the backlight.

Note3: The Luminance uniformity may be changed depending on the current variation between 6 circuits. It is recommended that the current value difference among the circuits be less than 5%.

4.3.3 Power supply voltage ripple

This product works if the ripple voltage levels are over the permissible values as the following table, but there might be noise on the display image.

Power supply voltage		Ripple voltage (Measure at input terminal of power supply)	Note1	Unit
VCC	3.3V	≤ 100		mVp-p

Note1: The permissible ripple voltage includes spike noise.

4.3.4 Fuse

Parameter	Fuse		Rating	Fusing current	Remarks
	Type	Supplier			
VCC	FCC16202AB	KAMAYA ELECTRIC Co., Ltd	2.0A	4.0A	Note1
			36V		

Note1: The power supply's rated current must be more than the fusing current. If it is less than the fusing current, the fuse may not blow in a short time, and then nasty smell, smoke and so on may occur.

4.4 POWER SUPPLY VOLTAGE SEQUENCE

4.4.1 LCD panel signal processing board

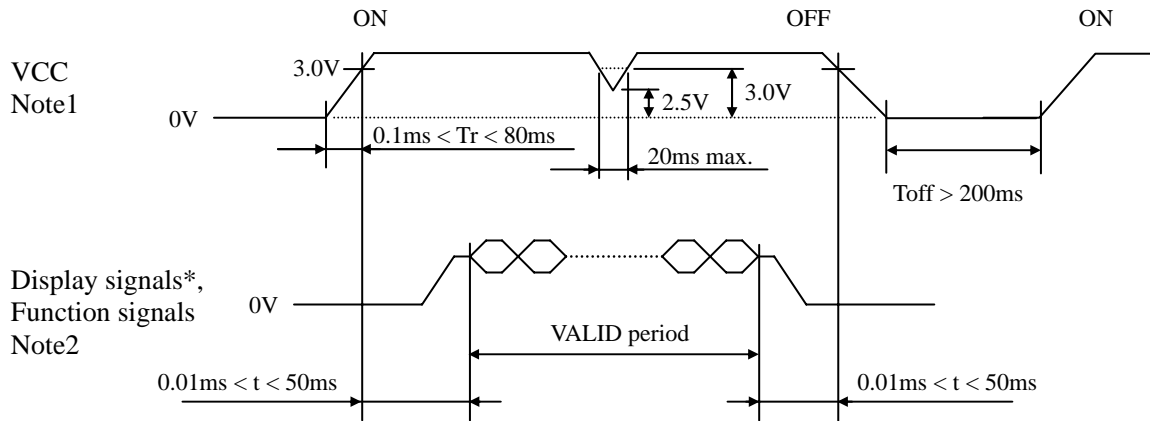

* These signals should be measured at the terminal of 100Ω resistance.

Note1: If there is a voltage variation (voltage drop) at the rising edge of VCC below 3.0V, there is a possibility that a product does not work due to a protection circuit.

Note2: Display signals (D0+/-, D1+/-, D2+/-, D3+/-, CLK+/-) and function signal (MSL) must be set to Low or High impedance, except the VALID period (See above sequence diagram), in order to avoid the circuitry damage.

If some of display and function signals of this product are cut while this product is working, even if the signal input to it once again, it might not work normally. If a customer stops the display and function signals, VCC also must be shut down.

4.4.2 LED driver board

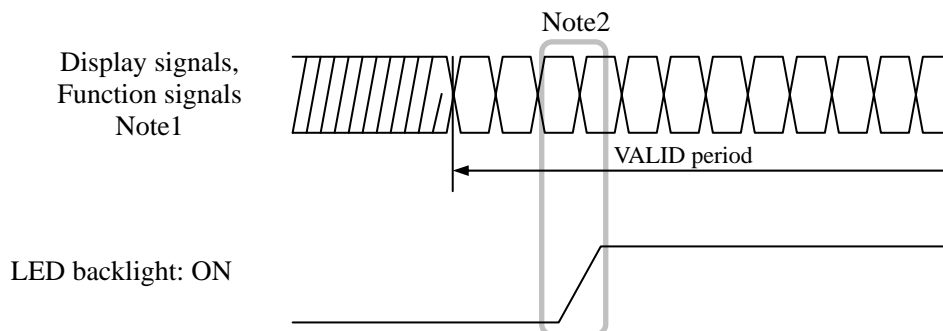

Note1: These are the display and function signals for LCD panel signal processing board.

Note2: The backlight should be turned on within the valid period of display and function signals, in order to avoid unstable data display.

4.5 CONNECTIONS AND FUNCTIONS FOR INTERFACE PINS

4.5.1 LCD panel signal processing board

CN1 socket (LCD module side): DF14H-20P-1.25H (Hirose Electric Co., Ltd. (HRS))

Adaptable plug: DF14-20S-1.25C (Hirose Electric Co., Ltd. (HRS))

Pin No.	Symbol	Signal	Remarks
1	VCC	Power supply	Note1
2	VCC		
3	GND	Ground	Note1
4	GND		
5	D0-	Pixel data	Note2
6	D0+		
7	GND	Ground	Note1
8	D1-	Pixel data	Note2
9	D1+		
10	GND	Ground	Note1
11	D2-	Pixel data	Note2
12	D2+		
13	GND	Ground	Note1
14	CLK-	Pixel clock	Note2
15	CLK+		
16	GND	Ground	Note1
17	D3-	Pixel data	Note2
18	D3+		
19	RSVD	Reserved	Keep this pin open.
20	MSL	Selection of LVDS input map	High: Input map A Low or Open: Input map B Note3, Note4

Note1: All GND and VCC terminals should be used without any non-connected lines.

Note2: Twist pair wires with 100Ω (Characteristic impedance) should be used between LCD panel signal processing board and LVDS transmitter.

Note3: See "4.5.4 Connection between receiver and transmitter for LVDS".

Note4: This terminal is pulled-down in the product. (Pull-down resistance: 50kΩ)

4.5.2 Backlight lamp

CN2 plug (LCD module side): SM12B-SRSS-TB (J.S.T. Mfg. Co., Ltd.)

Adaptable socket: SHR-12V-S (J.S.T. Mfg. Co., Ltd.)

Pin No.	Symbol	Signal	Remarks
1	A1	Anode1	-
2	K1	Cathode1	-
3	A2	Anode2	-
4	K2	Cathode2	-
5	A3	Anode3	-
6	K3	Cathode3	-
7	A4	Anode4	-
8	K4	Cathode4	-
9	A5	Anode5	-
10	K5	Cathode5	-
11	A6	Anode6	-
12	K6	Cathode6	-

4.5.3 Positions of plug and socket

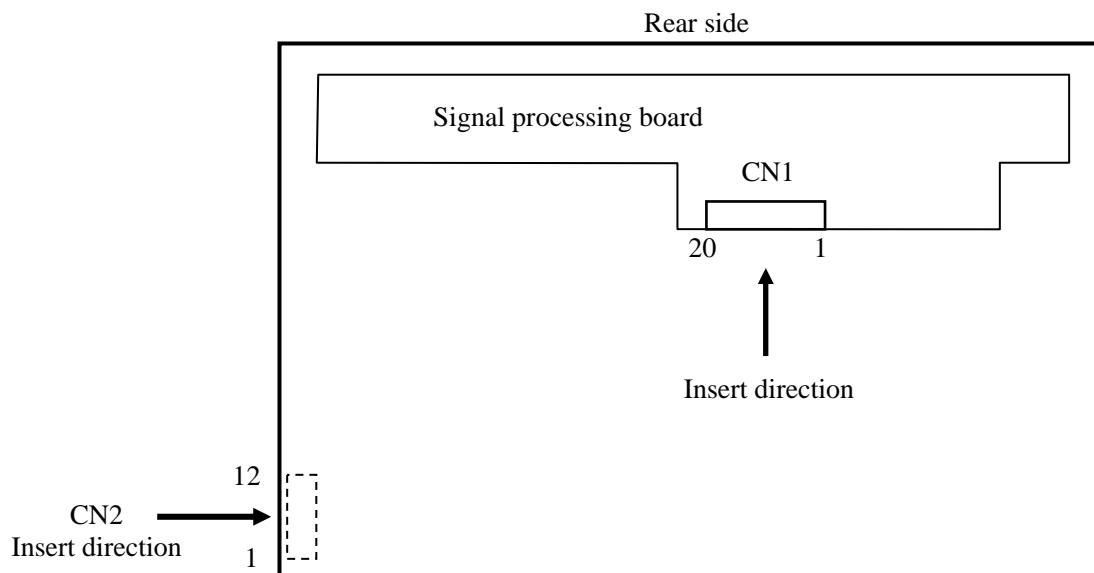

4.5.4 Connection between receiver and transmitter for LVDS

(1) Input LVDS map A (MSL: "High")

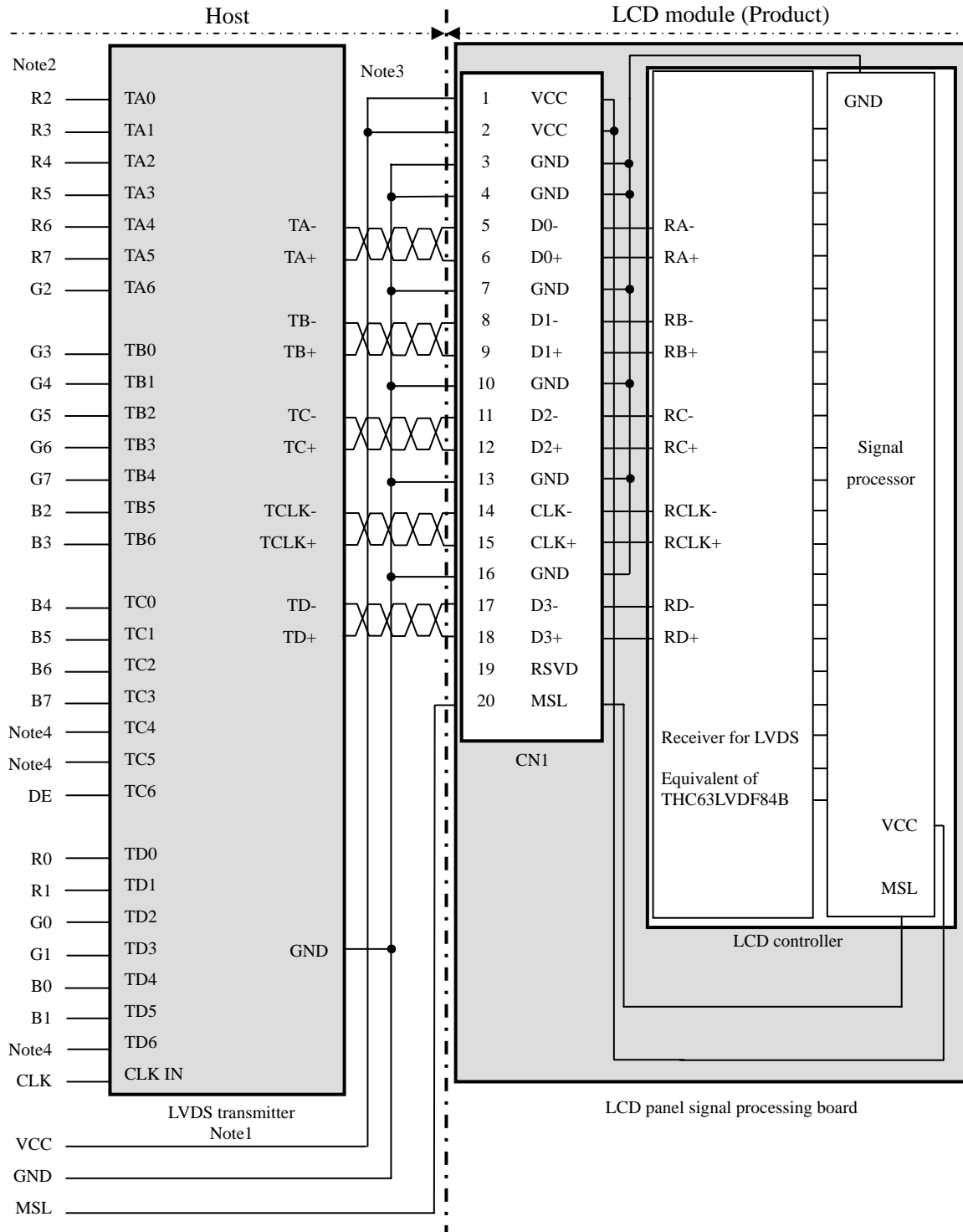

Note1: Recommended transmitter: THC63LVDM83D (THine Electronics Inc.) or equivalent

Note2: LSB (Least Significant Bit) – R0, G0, B0 MSB (Most Significant Bit) – R7, G7, B7

Note3: Twist pair wires with 100Ω (Characteristic impedance) should be used between LCD panel signal processing board and LVDS transmitter.

Note4: Input signals to TC4, TC5 and TD6 are not used inside the product, but do not keep TC4, TC5 and TD6 open to avoid noise problem.

(2) Input LVDS map B (MSL: "Low" or "Open")

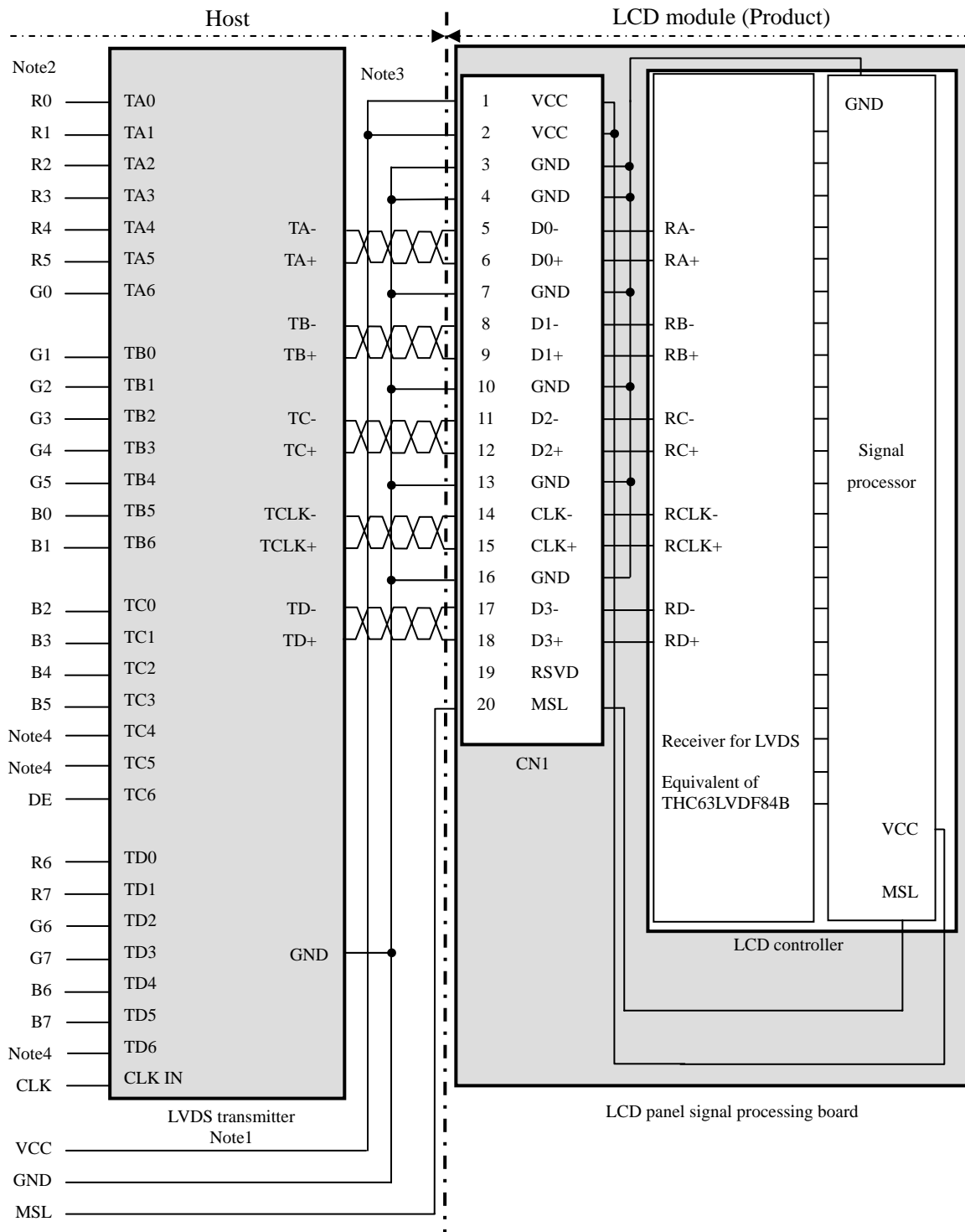

Note1: Recommended transmitter: THC63LVDM83D (THine Electronics Inc.) or equivalent

Note2: LSB (Least Significant Bit) – R0, G0, B0 MSB (Most Significant Bit) – R7, G7, B7

Note3: Twist pair wires with 100Ω (Characteristic impedance) should be used between LCD panel signal processing board and LVDS transmitter.

Note4: Input signals to TC4, TC5 and TD6 are not used inside the product, but do not keep TC4, TC5 and TD6 open to avoid noise problem.

4.6 DISPLAY COLORS AND INPUT DATA SIGNALS

This product can display 16,777,216 colors equivalent with 256 gray scales. Also the relation between display colors and input data signals is as follows;

Display colors		Data signal (0: Low level, 1: High level)																							
		R7	R6	R5	R4	R3	R2	R1	R0	G7	G6	G5	G4	G3	G2	G1	G0	B7	B6	B5	B4	B3	B2	B1	B0
Basic Colors	Black	0	0	0	0	0	0	0	0	0	0	0	0	0	0	0	0	0	0	0	0	0	0	0	0
	Blue	0	0	0	0	0	0	0	0	0	0	0	0	0	0	0	0	1	1	1	1	1	1	1	1
	Red	1	1	1	1	1	1	1	1	0	0	0	0	0	0	0	0	0	0	0	0	0	0	0	0
	Magenta	1	1	1	1	1	1	1	1	0	0	0	0	0	0	0	0	1	1	1	1	1	1	1	1
	Green	0	0	0	0	0	0	0	0	1	1	1	1	1	1	1	1	0	0	0	0	0	0	0	0
	Cyan	0	0	0	0	0	0	0	0	1	1	1	1	1	1	1	1	1	1	1	1	1	1	1	1
	Yellow	1	1	1	1	1	1	1	1	1	1	1	1	1	1	1	1	0	0	0	0	0	0	0	0
	White	1	1	1	1	1	1	1	1	1	1	1	1	1	1	1	1	1	1	1	1	1	1	1	1
Red gray scale	Black	0	0	0	0	0	0	0	0	0	0	0	0	0	0	0	0	0	0	0	0	0	0	0	0
		0	0	0	0	0	0	0	1	0	0	0	0	0	0	0	0	0	0	0	0	0	0	0	0
	dark	0	0	0	0	0	0	1	0	0	0	0	0	0	0	0	0	0	0	0	0	0	0	0	0
	↑																								
	↓																								
	bright	1	1	1	1	1	1	0	1	0	0	0	0	0	0	0	0	0	0	0	0	0	0	0	0
Red	1	1	1	1	1	1	1	0	0	0	0	0	0	0	0	0	0	0	0	0	0	0	0	0	
Red	1	1	1	1	1	1	1	1	0	0	0	0	0	0	0	0	0	0	0	0	0	0	0	0	
Green gray scale	Black	0	0	0	0	0	0	0	0	0	0	0	0	0	0	0	0	0	0	0	0	0	0	0	0
		0	0	0	0	0	0	0	0	0	0	0	0	0	0	0	1	0	0	0	0	0	0	0	0
	dark	0	0	0	0	0	0	0	0	0	0	0	0	0	0	1	0	0	0	0	0	0	0	0	0
	↑																								
	↓																								
	bright	0	0	0	0	0	0	0	0	1	1	1	1	1	1	0	1	0	0	0	0	0	0	0	0
Green	0	0	0	0	0	0	0	0	1	1	1	1	1	1	1	0	0	0	0	0	0	0	0	0	
Green	0	0	0	0	0	0	0	0	1	1	1	1	1	1	1	1	0	0	0	0	0	0	0	0	
Blue gray scale	Black	0	0	0	0	0	0	0	0	0	0	0	0	0	0	0	0	0	0	0	0	0	0	0	0
		0	0	0	0	0	0	0	0	0	0	0	0	0	0	0	0	0	0	0	0	0	0	0	1
	dark	0	0	0	0	0	0	0	0	0	0	0	0	0	0	0	0	0	0	0	0	0	0	1	0
	↑																								
	↓																								
	bright	0	0	0	0	0	0	0	0	0	0	0	0	0	0	0	0	1	1	1	1	1	1	0	1
Blue	0	0	0	0	0	0	0	0	0	0	0	0	0	0	0	0	1	1	1	1	1	1	1	0	
Blue	0	0	0	0	0	0	0	0	0	0	0	0	0	0	0	0	1	1	1	1	1	1	1	1	

4.7 DISPLAY POSITIONS

The following table is the coordinates per pixel (See "4.8 SCANNING DIRECTIONS").

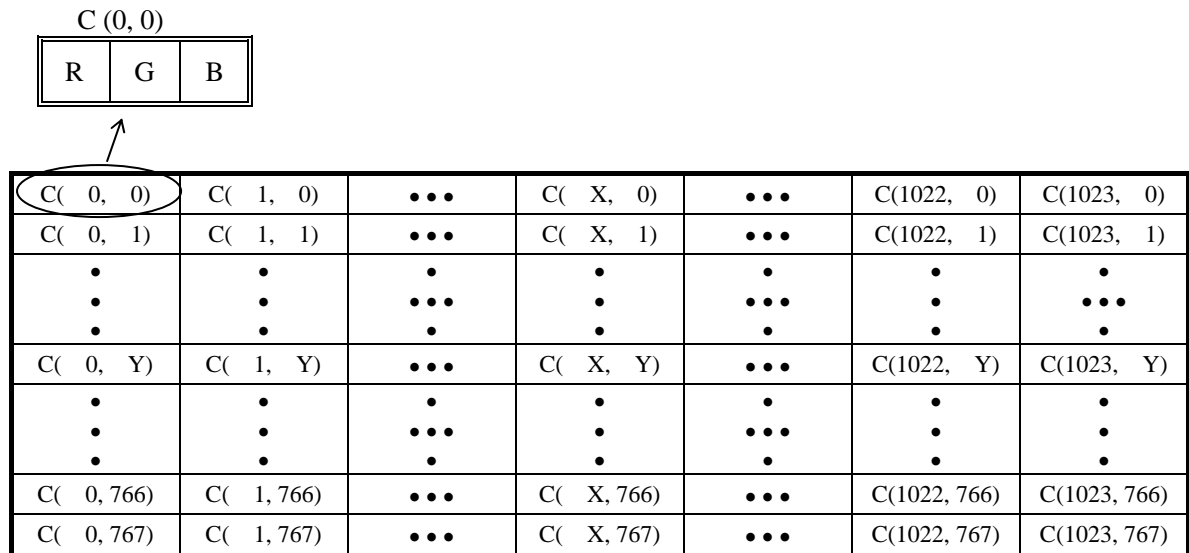

4.8 SCANNING DIRECTIONS

The following figures are seen from a front view.

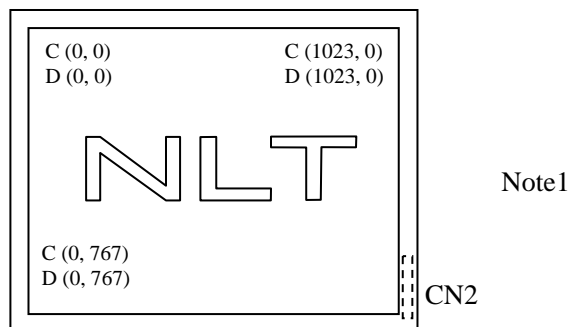

Note1: Meaning of C (X, Y) and D (X, Y)

C (X, Y): The coordinates of the display position (See "4.7 DISPLAY POSITIONS".)

D (X, Y): The data number of input signal for LCD panel signal processing board

4.9 INPUT SIGNAL TIMINGS

4.9.1 Outline of input signal timings

- Horizontal signal
Note1

- Vertical signal
Note1

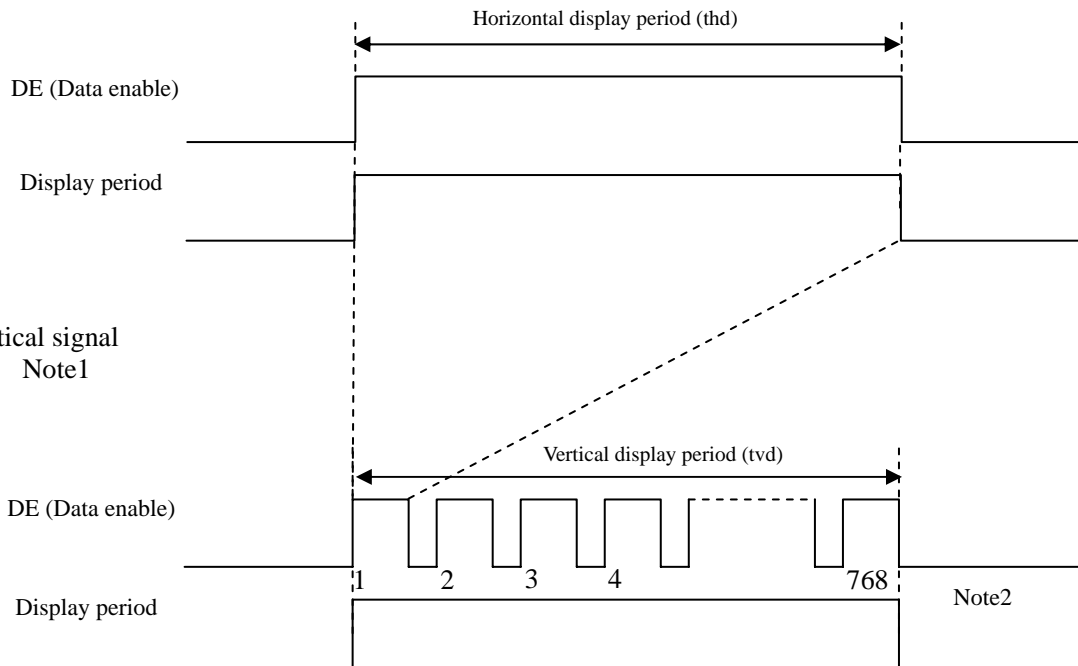

Note1: This diagram indicates virtual signal for set up to timing.
Note2: See "4.9.3 Input signal timing chart" for the pulse number.

4.9.2 Timing characteristics

(Note1, Note2, Note3)

Parameter		Symbol	min.	typ.	max.	Unit	Remarks	
CLK	Frequency	1/tc	60.0	65.0	80.0	MHz	15.384 ns (typ.)	
	Duty	-	-			-	-	
	Rise time, Fall time	-				ns		
DATA	CLK-DATA	Setup time	-			ns	-	
		Hold time				ns		
	Rise time, Fall time	-				ns		
DE	Horizontal	Cycle	th	16.000	20.676	-	μs	48.363 kHz (typ.)
		Display period	thd	1,100	1,344	1,800	CLK	
	Vertical	Cycle	tv	-	16.666	20.0	ms	60.000 Hz (typ.)
		Display period	tvd	771	806	-	H	
	CLK-DE	Setup time	-	-			ns	-
		Hold time	-				ns	
Rise time, Fall time		-	ns					

Note1: Definition of parameters is as follows.

tc= 1CLK, th= 1H

Note2: See the data sheet of LVDS transmitter.

Note3: Vertical cycle (tv) should be specified in integral multiple of Horizontal cycle (th).

4.9.3 Input signal timing chart

Horizontal timing

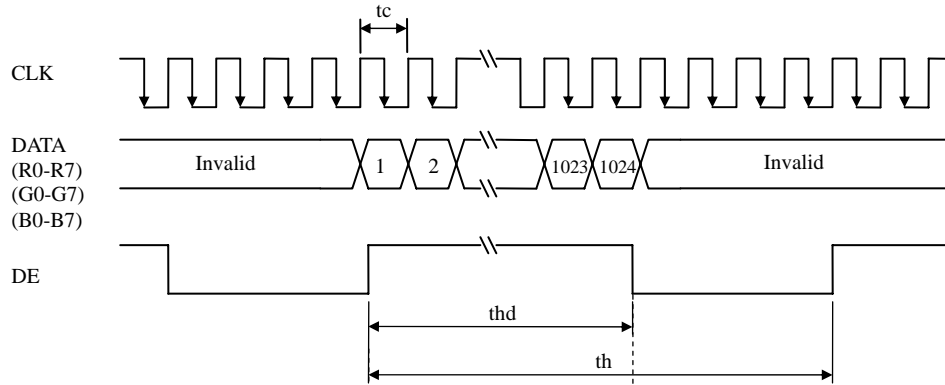

Vertical timing

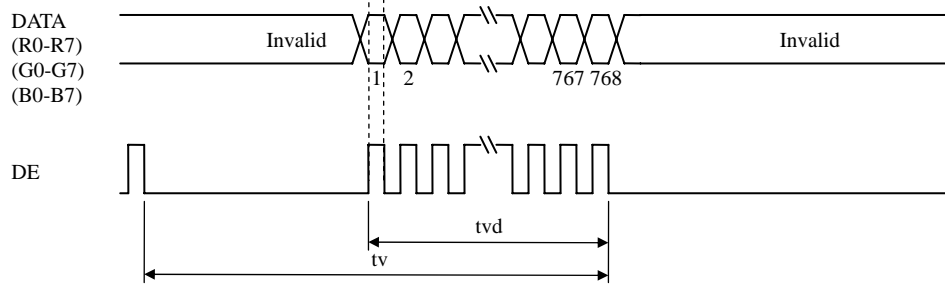

4.10 OPTICS

4.10.1 Optical characteristics

(Note1, Note2)

Parameter	Condition	Symbol	min.	typ.	max.	Unit	Measuring instrument	Remarks	
Luminance 1	White at center $\theta R=0^\circ, \theta L=0^\circ, \theta U=0^\circ, \theta D=0^\circ$	L1	250	330	-	cd/m ²	SR-3 or BM-5A	Note3 ☆	
Luminance 2	White at center $\theta R=0^\circ, \theta L=0^\circ, \theta U=0^\circ, \theta D=0^\circ$	L2	270	350	-	cd/m ²	SR-3 or BM-5A	Note4 ☆	
Contrast ratio	White/Black at center $\theta R=0^\circ, \theta L=0^\circ, \theta U=0^\circ, \theta D=0^\circ$	CR	500	900	-	-	SR-3 or BM-5A	Note5	
Luminance uniformity	White $\theta R=0^\circ, \theta L=0^\circ, \theta U=0^\circ, \theta D=0^\circ$	LU	-	1.2	1.35	-	BM-5A	Note6	
Chromaticity	White	x coordinate	Wx	0.263	0.313	0.363	-	SR-3	Note7 ☆
		y coordinate	Wy	0.279	0.329	0.379	-		
	Red	x coordinate	Rx	-	0.638	-	-		
		y coordinate	Ry	-	0.342	-	-		
	Green	x coordinate	Gx	-	0.311	-	-		
		y coordinate	Gy	-	0.622	-	-		
Blue	x coordinate	Bx	-	0.150	-	-			
	y coordinate	By	-	0.068	-	-			
Color gamut	$\theta R=0^\circ, \theta L=0^\circ, \theta U=0^\circ, \theta D=0^\circ$ at center, against NTSC color space	C	65	72	-	%			
Response time	Black to White	Ton	-	14	20	ms	BM-5A	Note8	
	White to Black	Toff	-	11	20	ms		Note9	
Viewing angle	Right	$\theta U=0^\circ, \theta D=0^\circ, CR \geq 10$	θR	70	88	-	BM-5A or EZ Contrast	Note10	
	Left	$\theta U=0^\circ, \theta D=0^\circ, CR \geq 10$	θL	70	88	-			
	Up	$\theta R=0^\circ, \theta L=0^\circ, CR \geq 10$	θU	70	88	-			
	Down	$\theta R=0^\circ, \theta L=0^\circ, CR \geq 10$	θD	70	88	-			

Note1: These are initial characteristics.

Note2: Measurement conditions are as follows.

Ta= 25°C, VCC= 3.3V, IL= 50mA (Luminance 1) or 55mA (Luminance 2) / One circuit, ☆
 Display mode: XGA, Horizontal cycle= 1/48.363kHz, Vertical cycle= 1/60.0Hz

Optical characteristics are measured at luminance saturation 20minutes after the product works in the dark room. Also measurement methods are as follows.

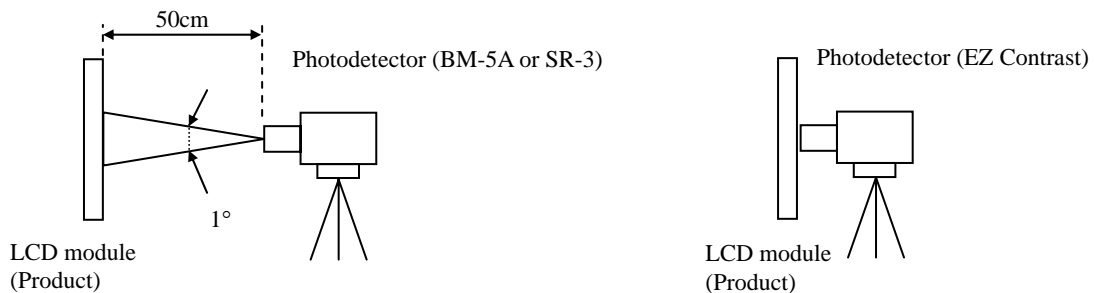

Note3: At IL = 50mA / One Circuit

Note4: At IL = 55mA / One Circuit

Note5: See "4.10.2 Definition of contrast ratio".

Note6: See "4.10.3 Definition of luminance uniformity".

Note7: These coordinates are found on CIE 1931 chromaticity diagram.

Note8: Product surface temperature: TopF= 30°C

Note9: See "4.10.4 Definition of response times".

Note10: See "4.10.5 Definition of viewing angles".

4.10.2 Definition of contrast ratio

The contrast ratio is calculated by using the following formula.

$$\text{Contrast ratio (CR)} = \frac{\text{Luminance of white screen}}{\text{Luminance of black screen}}$$

4.10.3 Definition of luminance uniformity

The luminance uniformity is calculated by using following formula.

$$\text{Luminance uniformity (LU)} = \frac{\text{Maximum luminance from ① to ⑤}}{\text{Minimum luminance from ① to ⑤}}$$

The luminance is measured at near the 5 points shown below.

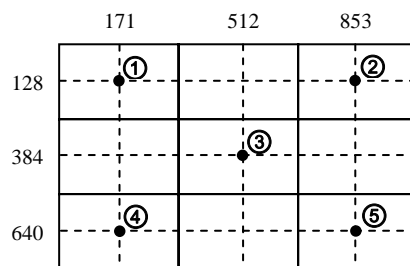

4.10.4 Definition of response times

Response time is measured at the time when the luminance changes from "black" to "white", or "white" to "black" on the same screen point, by photo-detector. Ton is the time when the luminance changes from 10% up to 90%. Also Toff is the time when the luminance changes from 90% down to 10% (See the following diagram.).

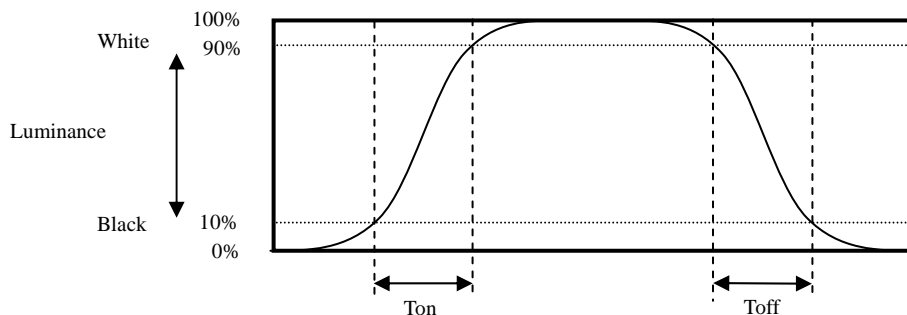

4.10.5 Definition of viewing angles

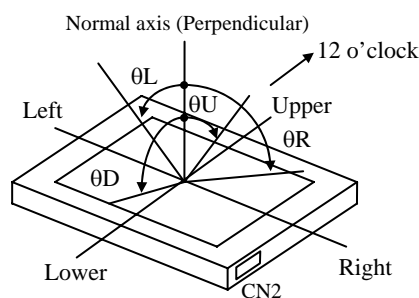

5. ESTIMATED LUMINANCE LIFETIME

The luminance lifetime is the time from initial luminance to half-luminance.

This lifetime is the estimated value, and is not guarantee value.

1. Luminance 1: 330 cd/m² (typ.)

Condition		Estimated luminance lifetime (Life time expectancy) Note1, Note2, Note3	Unit
LED elementary substance	25°C (Ambient temperature of the product) Continuous operation, IL= 50mA/One circuit	70,000	h
	70°C (Surface temperature at screen center) Continuous operation, IL= 50mA/One circuit	60,000	h

2. Luminance 2: 350 cd/m² (typ.)



Condition		Estimated luminance lifetime (Life time expectancy) Note1, Note2, Note3	Unit
LED elementary substance	25°C (Ambient temperature of the product) Continuous operation, IL= 55mA/One circuit	70,000	h
	60°C (Surface temperature at screen center) Continuous operation, IL= 55mA/One circuit	60,000	h

Note1: Life time expectancy is mean time to half-luminance.

Note2: Estimated luminance lifetime is not the value for an LCD module but the value for LED elementary substance.

Note3: By ambient temperature, the lifetime changes particularly. Especially, in case the product works under high temperature environment, the lifetime becomes short.

6. RELIABILITY TESTS

Test item	Condition	Note2	Judgment	Note
High temperature and humidity (Operation)	① 60 ± 2°C, RH= 90%, 240hours		No display malfunctions	
	② Display data is white.			
High temperature (Operation)	① 70 ± 3°C, 240hours			
	② Display data is white.			
Heat cycle (Operation)	① -20 ± 3°C 1hour 70 ± 3°C 1hour			
	② 50cycles, 4hours/cycle			
	③ Display data is white.			
Thermal shock (Non operation)	① -20 ± 3°C 30minutes 80 ± 3°C 30minutes		No display malfunctions No physical damages	
	② 100cycles, 1hour/cycle			
	③ Temperature transition time is within 5 minutes.			
ESD (Operation)	① 150pF, 150Ω, ±10kV			
	② 9 places on a panel surface	Note3		
	③ 10 times each places at 1 sec interval			
Dust (Operation)	① Sample dust: No. 15 (by JIS-Z8901)			
	② 15 seconds stir			
	③ 8 times repeat at 1 hour interval			
Vibration (Non operation)	① 5 to 100Hz, 11.76m/s ²			
	② 1 minute/cycle			
	③ X, Y, Z directions			
Mechanical shock (Non operation)	① 294m/s ² , 11ms			
	② X, Y, Z directions			
	③ 3 times each directions			
Low pressure	Operation	① 53.3kPa (Equivalent to altitude 4,850m)	No display malfunctions	
		② -20°C±3°C 24 hours		
	③ 70°C±3°C 24 hours			
Non-operation	① 15kPa (Equivalent to altitude 13,600m)			
	② -20°C±3°C 24 hours			
	③ 80°C±3°C 24 hours			

Note1: Display and appearance are checked under environmental conditions equivalent to the inspection conditions of defect criteria.

Note2: IL= 50mA / One circuit

Note3: See the following figure for discharge points.

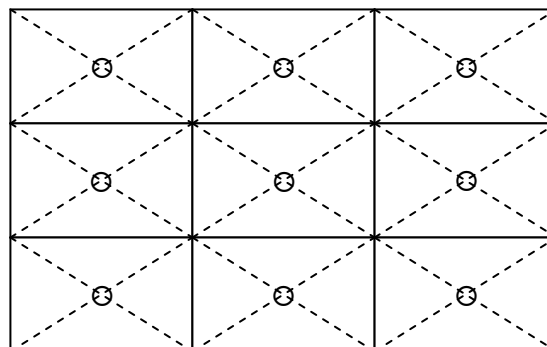

7. PRECAUTIONS

7.1 MEANING OF CAUTION SIGNS

The following caution signs have very important meaning. **Be sure to read "7.2 CAUTIONS" and "7.3 ATTENTIONS"!**

	This sign has the meaning that a customer will be injured or the product will sustain damage if the customer practices wrong operations.
---	--

	This sign has the meaning that a customer will be injured, if the customer practices wrong operations.
---	--

7.2 CAUTIONS

	<p>* Do not shock and press the LCD panel and the backlight! There is a danger of breaking, because they are made of glass. (Shock: Equal to or no greater than 294m/s² and equal to or no greater than 11ms, Pressure: Equal to or no greater than 19.6 N (φ16mm jig))</p>
---	---

7.3 ATTENTIONS 

7.3.1 Handling of the product

- ① Take hold of both ends without touching the circuit board when the product (LCD module) is picked up from inner packing box to avoid broken down or misadjustment, because of stress to mounting parts on the circuit board.
- ② When the product is put on the table temporarily, display surface must be placed downward.
- ③ When handling the product, take the measures of electrostatic discharge with such as earth band, ionic shower and so on, because the product may be damaged by electrostatic.
- ④ The torque for product mounting screws must never exceed 0.343N·m. Higher torque might result in distortion of the bezel. And the length of product mounting screws must be ≤ 2.8mm.
- ⑤ The product must be installed using mounting holes without undue stress such as bends or twist (See outline drawings). And do not add undue stress to any portion (such as bezel flat area). Bends or twist described above and undue stress to any portion may cause display mura.
- ⑥ Do not press or rub on the sensitive product surface. When cleaning the panel surface, wipe it with a soft dry cloth.
- ⑦ Do not push or pull the interface connectors while the product is working.
- ⑧ When handling the product, use of an original protection sheet on the product surface (polarizer) is recommended for protection of product surface. Adhesive type protection sheet may change color or characteristics of the polarizer.
- ⑨ Usually liquid crystals don't leak through the breakage of glasses because of the surface tension of thin layer and the construction of LCD panel. But, if you contact with liquid crystal by any chance, please wash it away with soap and water.

7.3.2 Environment

- ① Do not operate or store in high temperature, high humidity, dewdrop atmosphere or corrosive gases. Keep the product in packing box with antistatic pouch in room temperature to avoid dusts and sunlight, when storing the product.
- ② In order to prevent dew condensation occurred by temperature difference, the product packing box must be opened after enough time being left under the environment of an unpacking room. Evaluate the storage time sufficiently because dew condensation is affected by the environmental temperature and humidity. (Recommended storage time: 6 hours or more with the original packing state after a customer receives the package)
- ③ Do not operate in high magnetic field. Circuit boards may be broken.
- ④ This product is not designed as radiation hardened.

7.3.3 Characteristics

The following items are neither defects nor failures.

- ① Characteristics of the LCD (such as response time, luminance, color uniformity and so on) may be changed depending on ambient temperature. If the product is stored under condition of low temperature for a long time, it may cause display mura. In this case, the product should be operated after enough time being left under condition of operating temperature.
- ② Display mura, flickering, vertical streams or tiny spots may be observed depending on display patterns.
- ③ Do not display the fixed pattern for a long time because it may cause image sticking. Use a screen saver, if the fixed pattern is displayed on the screen.
- ④ The display color may be changed depending on viewing angle because of the use of condenser sheet in the backlight.
- ⑤ Optical characteristics may be changed depending on input signal timings.

7.3.4 Others

- ① All GND and VCC terminals should be used without any non-connected lines.
- ② Do not disassemble a product or adjust variable resistors.
- ③ See "REPLACEMENT MANUAL FOR LAMP HOLDER SET", when replacing lamp holder set.
- ④ Pack the product with the original shipping package, in order to avoid any damages during transportation, when returning the product to NLT for repairing and so on.
- ⑤ The information of China RoHS directive six hazardous substances or elements in this product is as follows.

China RoHS directive six hazardous substances or elements					
Lead (Pb)	Mercury (Hg)	Cadmium (Cd)	Hexavalent Chromium (Cr VI)	Polybrominated Biphenyls (PBB)	Polybrominated Biphenyl Ethers (PBDE)
×	○	○	○	○	○

Note1: ○: This indicates that the poisonous or harmful material in all the homogeneous materials for this part is equal or below the limitation level of SJ/T11363-2006 standard regulation.

×: This indicates that the poisonous or harmful material in all the homogeneous materials for this part is above the limitation level of SJ/T11363-2006 standard regulation.

8. OUTLINE DRAWINGS

8.1 FRONT VIEW

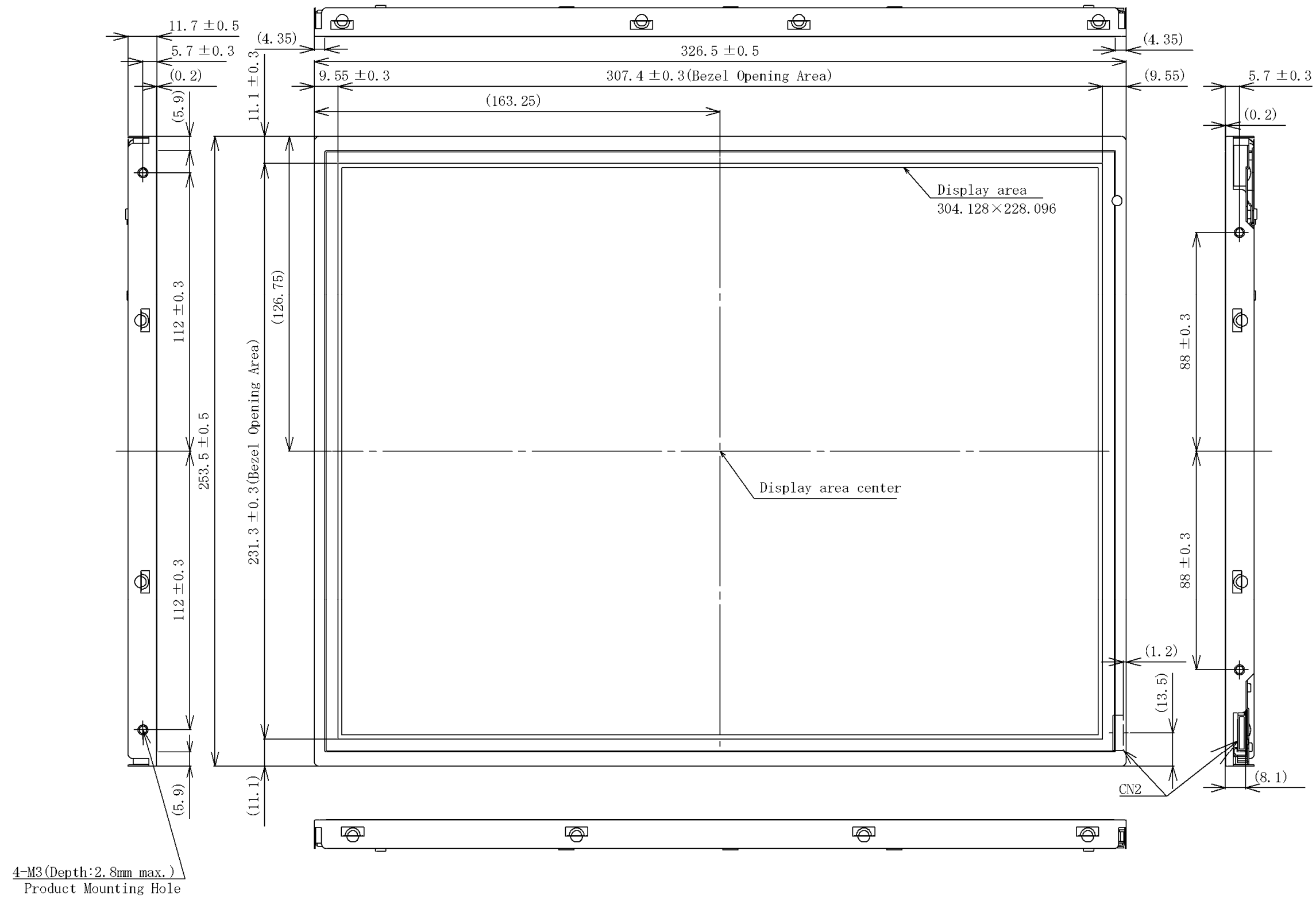

Note1: The values in parentheses are for reference.

Note2: The torque for product mounting screws must never exceed 0.343N·m. And the length of product mounting screws must be ≤ 2.8 mm.

Unit: mm

8.2 REAR VIEW

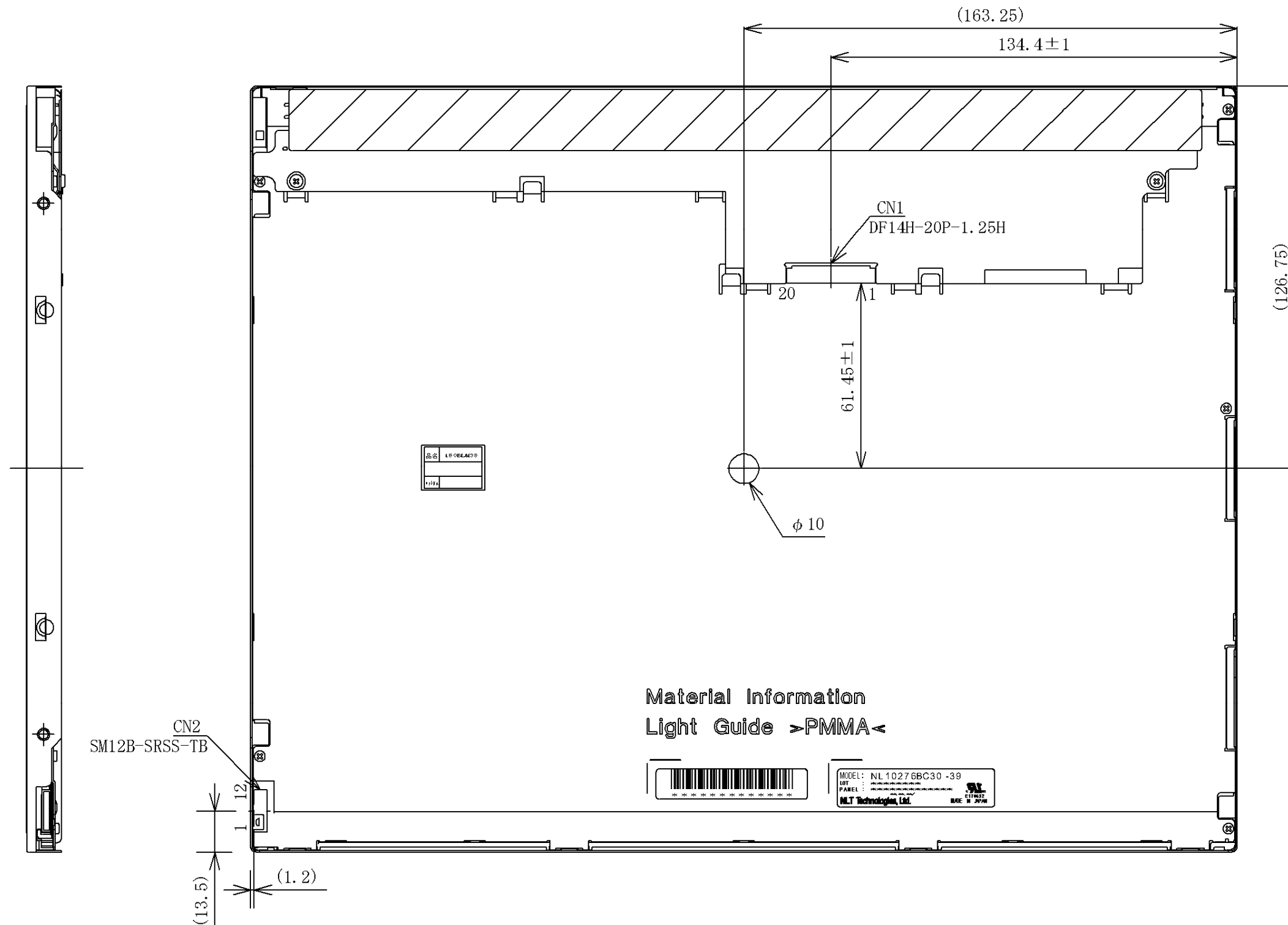

Note1: The values in parentheses are for reference.

Note2: The torque for product mounting screws must never exceed 0.343N·m. And the length of product mounting screws must be ≤ 2.8mm.

Unit: mm

Our company network supports you worldwide with offices in Germany, Austria, Switzerland, the UK and the USA. For more information please contact:

Headquarters

Germany



FORTEC Elektronik AG

Lechwiesenstr. 9
86899 Landsberg am Lech

Phone: +49 8191 91172-0
E-Mail: sales@forteca.de
Internet: www.forteca.de

Fortec Group Members

Austria



FORTEC Elektronik AG

Office Vienna

Nuschinggasse 12
1230 Wien

Phone: +43 1 8673492-0
E-Mail: office@fortec.at
Internet: www.fortec.at

Germany



Distec GmbH

Augsburger Str. 2b
82110 Germering

Phone: +49 89 894363-0
E-Mail: info@distec.de
Internet: www.distec.de

Switzerland



ALTRAC AG

Bahnhofstraße 3
5436 Würenlos

Phone: +41 44 7446111
E-Mail: info@altrac.ch
Internet: www.altrac.ch

United Kingdom



Display Technology Ltd.

Osprey House, 1 Osprey Court
Hichingbrooke Business Park
Huntingdon, Cambridgeshire, PE29 6FN

Phone: +44 1480 411600
E-Mail: info@displaytechnology.co.uk
Internet: www.displaytechnology.co.uk

USA



Apollo Display Technologies, Corp.

87 Raynor Avenue,
Unit 1 Ronkonkoma,
NY 11779

Phone: +1 631 5804360
E-Mail: info@apolloDisplays.com
Internet: www.apolloDisplays.com