



OUR GLOBAL  
COMPETENCE  
CENTRES

 APOLLO DISPLAY  
TECHNOLOGIES



 DISTEC



 DISPLAY  
TECHNOLOGY



# Datasheet

## SGD

**GTTQ57SN762E0**

SG-01-010





Product Specification				
	Model: GTTQ57SN762E0	Rev. No.	Issued Date.	Page.
		A	April. 30, 10	1 / 19

Thin-Film-Transistor LCD Module  
Model: GTTQ57SN762E0

Acceptance

**Solomon Goldentek Display Corp.**  
NO. 18 Ta-Yeh St., Ta-Fa Industrial Park, Ta-Liao  
Hsiang, Kaohsiung Hsien 831, TAIWAN , R.O.C.  
FAX: 886-7-7886800

Approved and Checked by

Approved by	Checked by		Made by
			

## Product Specification

	Model: GTTQ57SN762E0	Rev. No.	Issued Date.	Page.
		A	April. 30, 10	2 / 19

### Revise Records

Rev.	Date	Contents	Written	Approved
A	2007/09/11	Preliminary Specification	Kavin Chang	James Lu
B	2010/04/30	Revise the wrongly written character	Kavin Chang	Sychang

### Special Notes

Note1.	
Note2.	
Note3.	
Note4.	
Note5.	

Product Specification				
	Model: GTTQ57SN762E0	Rev. No.	Issued Date.	Page.
		A	April. 30, 10	3 / 19

## Contents

- 1. General Description and Features .....4**
  - 1.1 Features .....4
  - 1.2 LCD Module .....4
- 2. Mechanical Information .....4**
- 3. Electrical Specifications.....5**
  - 3.1 Absolute Max. Ratings .....5
  - 3.2 Electrical Characteristics .....7
  - 3.3 AC Timing Characteristic of The LCD .....8
  - 3.4 Back-Light Unit.....10
- 4. Optical Characteristics ..... 11**
  - 4.1 Optical characteristic of the LCD..... 11
- 5. I/O Terminal .....14**
  - 5.1 Pin Assignment .....14
  - 5.2 Block Diagram .....16
  - 5.3 Back-light Unit (BLU) .....16
  - 5.4 Basic Display Color and Gray Scale.....17
- 6. Test.....18**
- 7. Dimensional Outlines.....19**

## Product Specification

	Model: GTTQ57SN762E0	Rev. No.	Issued Date.	Page.
		A	April. 30, 10	4 / 19

### 1. General Description and Features

GTTQ57SN762E0 is a transmissive type color active matrix TFT (Thin Film Transistor) liquid crystal display (LCD) that uses amorphous silicon TFT as a switching device. This model is composed of a TFT-LCD module, a driver circuit and a back-light unit. Graphics and texts can be displayed on a QVGA 320 (W) x 3 x 240 (H) dots with 262,144 colors by supplying 18 bits data signal (6bits/each color). The following table described the features of GTTQ57SN762E0.

#### 1.1 Features

- Transmissive and back-light with 30th LEDs are available.
- TN (Twisted Nematic) mode.
- Digital RGB (6bits/color) data transfer.

#### 1.2 LCD Module

Item	Specification	Unit
Screen Size	5.7 inches	Diagonal
Display Resolution	320 (H) x 240 (V)	Pixel
Active Area	115.20 (H) x 86.40 (V)	mm
Outline Dimension	144.00 (H) x 104.60 (V) x 13.0 (T)	mm
Display Mode	Normally white mode/ Transmissive/ Wide view	--
Pixel Arrangement	R,G,B Vertical Tripe	--
Pixel size	120 x 360	um
Display Color	262K Colors	--
Viewing Direction	6 o'clock	--
Input Interface	Digital RGB (6bits/color) Data Transfer	--

### 2. Mechanical Information

Item	Min.	Typ.	Max.	Unit	Note	
Module Size	Horizontal (H)	--	144.00	--	mm	(1,2,3)
	Vertical (V)	--	104.60	--	mm	(2)
	Thickness (T)	--	13.0	--	mm	(1,3)
Weight	--	TBD	--	g	--	

Note (1) Not include FPC. Refer to the Outline Dimension Drawing as attached.

(2) Back-light unit is included.

(3) Excluding backlight cables.

## Product Specification

	Model: GTTQ57SN762E0	Rev. No.	Issued Date.	Page.
		A	April. 30, 10	5 / 19

### 3. Electrical Specifications

#### 3.1 Absolute Max. Ratings

##### 3.1.1 Absolute Ratings of Environment

If the operating condition exceeds the following absolute maximum ratings, the TFT LCD module may be damaged permanently.

(Ta=25±2°C, V<sub>SS</sub>=GND=0)

Item	Symbol	Min.	Max.	Unit	Note
Storage temperature	T <sub>STG</sub>	-30	80	°C	(1)
Operating temperature	T <sub>OPR</sub>	-20	70	°C	(1,2,3)

Note (1) 95 % RH Max. ( 40 °C ≥ Ta ). Maximum wet-bulb temperature at 39 °C or less. (Ta > 40 °C) No condensation.

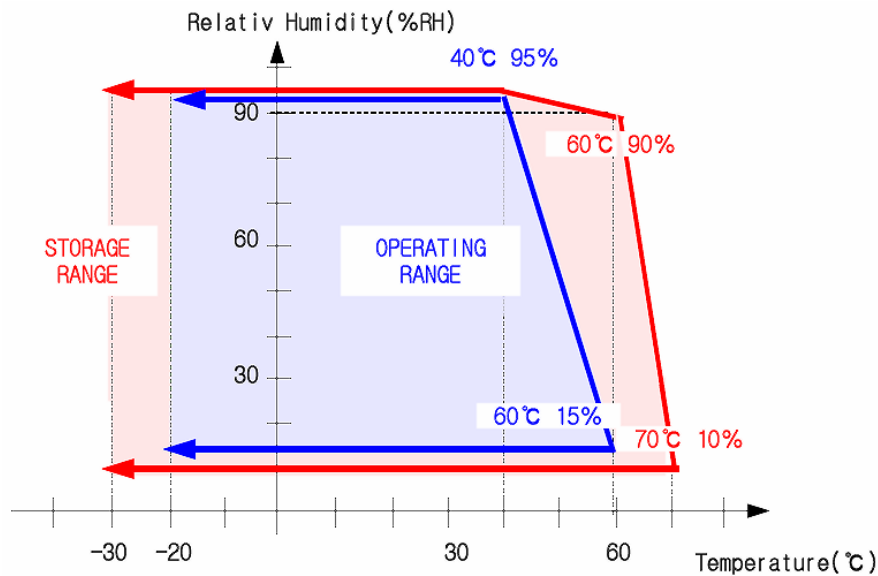

Note (2) In case of below 0°, the response time of liquid crystal (LC) becomes slower and the color of panel becomes darker than normal one. Level of retardation depends on temperature, because of LC's character

Note (3) Only operation is guaranteed at operating temperature. Contrast, response time, another display quality are evaluated at +25°C.

## Product Specification

	Model: GTTQ57SN762E0	Rev. No.	Issued Date.	Page.
		A	April. 30, 10	6 / 19

### 3.1.2 Electrical Absolute Maximum Ratings

( $V_{SS}=GND=0$ )

Parameter	Symbol	Min.	Max.	Unit	Remark
Power supply voltage	$V_{CC}$	-0.3	5.0	V	
Signal input voltage	R0-R5,G0-G5, B0-B5,DCLK,DE	-0.3	$V_{CC}+0.3$	V	--
Permissive input ripple voltage	$V_{RF}$	--	100	mVp-p	$V_{CC} = +3.3V$

Display On/Off Sequence :

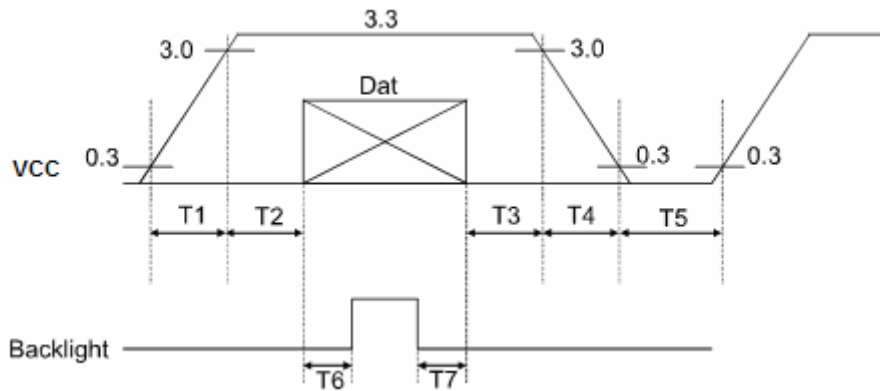

Data: DCLK, R0 ~ R5, G0 ~ G5, B0 ~ B5, DE

$T1 \leq 10ms$ ,  $50ms \leq T2$ ,  $0 < T3 \leq 50ms$ ,  $0 < T4 \leq 10ms$ ,  $1s \leq T5$ ,  $200ms \leq T6$ ,  $200ms \leq T7$



## Product Specification

	Model: GTTQ57SN762E0	Rev. No.	Issued Date.	Page.
		A	April. 30, 10	7 / 19

### 3.2 Electrical Characteristics

#### 3.2.1 DC Electrical Characteristics of the TFT LCD

(Ta=25±2°C, V<sub>SS</sub>=GND=0)

Item	Symbol	Min.	Typ.	Max.	Unit	Remark
Power supply	VCC	3.0	3.3	3.6	V	Note 1
Input Voltage for logic	H Level	0.7VDD	-	VDD	V	
	L Level	0	-	0.3VDD	V	
Power Supply current	ICC		(65)	TBD	mA	Note 2

Note1: Vcc-dip conditions

Vcc-dip conditions should also follow the Vcc-turn-on conditions

Td ≤ 10ms

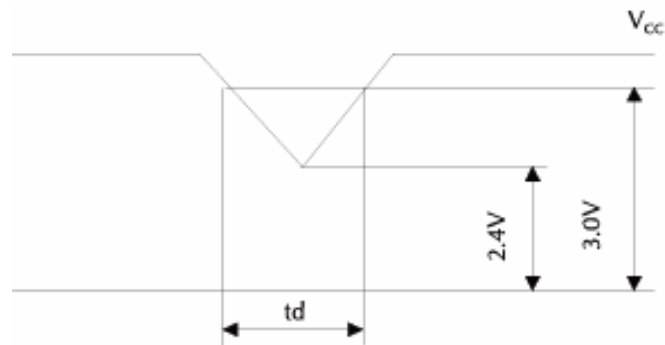

Note2: fv =60Hz , Ta=25°C , Display pattern : 64 Gray pattern

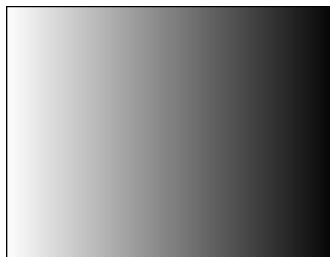

## Product Specification

	Model: GTTQ57SN762E0	Rev. No.	Issued Date.	Page.
		A	April. 30, 10	8 / 19

### 3.3 AC Timing Characteristic of The LCD

#### 3.3.1 Timing Condition

Signal	Parameter	Symbol	Min.	Typ.	Max.	Unit.	Remark	
DCLK	DCLK period	TOSC	-	156	-	ns		
	Frequency	FOSC	-	6.4	-	MHz		
	DCLK High plus width	TCH	-	78	-	ns		
	DCLK Low plus width	TCL	-	78	-	ns		
RGB DATA	Data setup time	TSU	12	-	-	ns		
	Data hold time	THD	12	-	-	ns		
Hsync	Hsync period	TH	-	408	-	TOSC		
	Hsync pulse width	THS	5	30	-	TOSC		
	Back-Porch	THB		38		TOSC		
	Front-Porch	THF		20		TOSC		
	Hsync rising time	TCr	-	-	700	ns		
	Hsync falling time	TCf	-	-	300	ns		
Vsync	Vsync period	NTSC	-	262	-	TH		
		PAL	-	312	-	TH		
	Vsync pulse width	TVS	1	3	5	TH		
	Back-Porch	NTSC	TVB		15		TH	
		PAL			23		TH	
	Display Period	TVD		240		TH		
	Front Porch	NTSC	TVF		5		TH	
		PAL			46		TH	
	Vsync rising time	TVr	-	-	700	ns		
	Vsync falling time	TVf	-	-	1.5	μs		
Vsync falling to Hsync rising time for odd field	THVO	1	-	-	TOSC			
Vsync falling to Hsync falling time for even field	THVE	1	-	-	TOSC			
DEN	Vsync-DEN time	NTSC	TVSE	-	18	-	TH	
		PAL	TVSE	-	26	-	TH	
	Hsync-DEN time	THE	36	68	88	TOSC		
	DEN plus width	TEP	-	320	-	TOSC		

Note : If DEN is fixed to low, the SYNC mode is used. Otherwise DE mode is used. When SYNC mode is used, 1st data start from 68th CLK after H-sync falling

# Product Specification

	Model: GTTQ57SN762E0	Rev. No.	Issued Date.	Page.
		A	April. 30, 10	9 / 19

### 3.3.2 Horizontal Display Timing

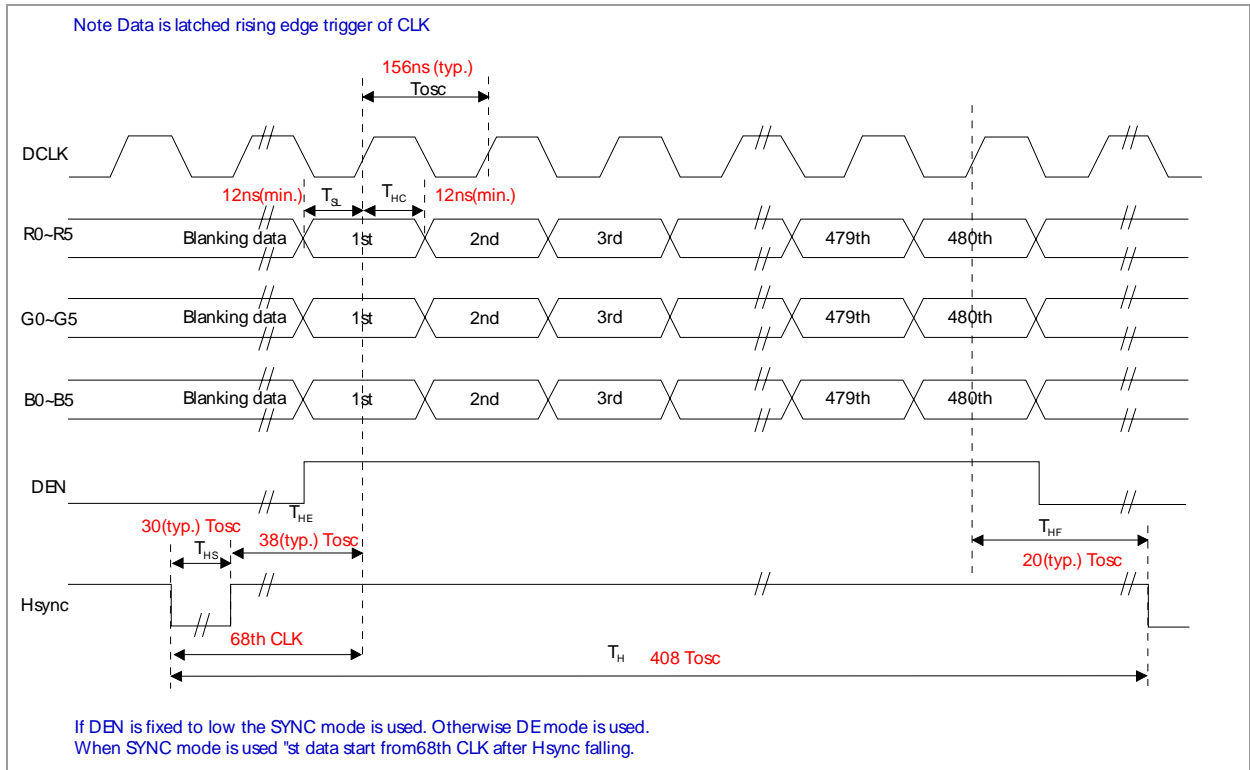

### 3.3.3 Vertical Display Timing

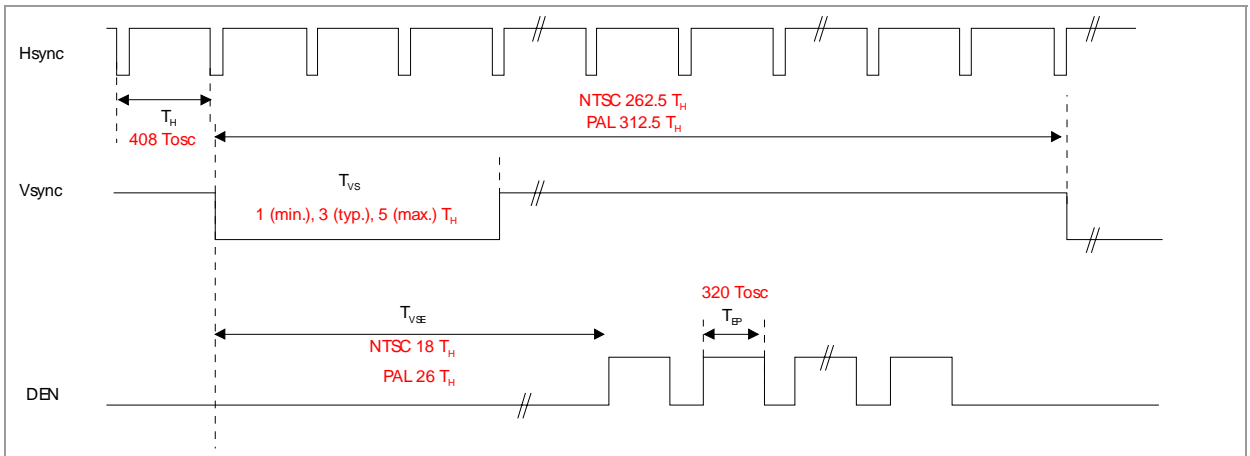

## Product Specification

	Model: GTTQ57SN762E0	Rev. No.	Issued Date.	Page.
		A	April. 30, 10	10 / 19

### 3.3.4 Hsync and Vsync Timing

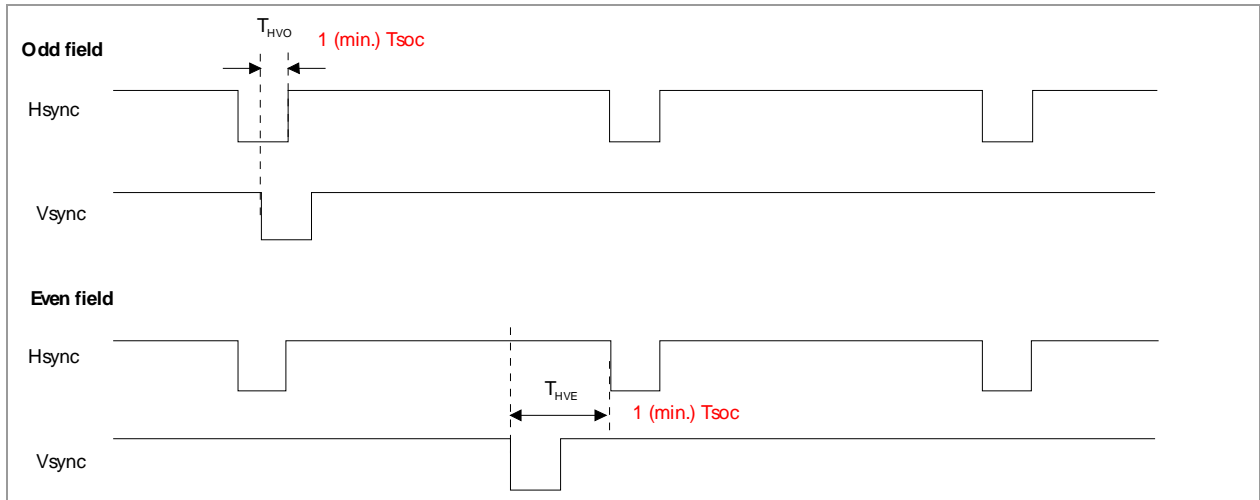

### 3.4 Back-Light Unit

The Back-light system is an edge-lighting type with 30 white LED(Light Emitting Diode)s. The characteristics of 30 white LEDs are shown in the following tables.

(Ta= Room Temp)

Characteristics		Symbol	Min.	Typ.	Max.	Unit	Note
Current		$I_B$	-	200	TBD	mA	(1)
Voltage Forward		$V_F$	-	(9.6)		V	
Power Consumption		$P_{BL}$	-	(1920)		mW	(2)
LED Life Time	25°C	-	(40000)	-	-	hr	(3)

Note (1) LEDS in 3 series x 10 parallel type.

(2) Where  $I_B = 200\text{mA}$ ,  $V_F = 9.6$ ,  $P_{BL} = V_F \times I_B$

(3) The environmental conducted under ambient air flow ,at  $T_a=25\pm 2^\circ\text{C}$ ,  $60\%\text{RH}\pm 5\%$

## Product Specification

	Model: GTTQ57SN762E0	Rev. No.	Issued Date.	Page.
		A	April. 30, 10	11 / 19

### 4. Optical Characteristics

#### 4.1 Optical characteristic of the LCD

The following items are measured under stable conditions. The optical characteristics should be measured in a dark room or equivalent state with the methods shown in Note (1).

Measuring equipment: BM-5A, BM-7

Item	Symbol	Condition	Min	Type	Max	Unit	Note
Brightness			480	600	--	cd/m <sup>2</sup>	
Response time	T <sub>r</sub>	θ=0°	-	15	20	ms	.
	T <sub>f</sub>		--	25	35	ms	
Contrast ratio	CR	At optimized viewing angle	300	(450)	--	--	
Color Gamut	NTSC %	--	--	50	--	%	
Color Chromaticity (CIE 1931)	Red	R <sub>x</sub>	θ=0° Normal Viewing Angle	0.610	0.640	0.670	--
		R <sub>y</sub>		0.314	0.344	0.374	
	Green	G <sub>x</sub>		0.268	0.298	0.328	--
		G <sub>y</sub>		0.553	0.583	0.613	
	Blue	B <sub>x</sub>		0.107	0.137	0.167	--
		B <sub>y</sub>		0.139	0.159	0.179	
	White	W <sub>x</sub>		0.282	0.312	0.342	--
		W <sub>y</sub>		0.309	0.339	0.369	
Viewing Angle (6H)	Hor.	θ <sub>R</sub>	CR≥10	55	65	--	Degree
		θ <sub>L</sub>		55	65	--	
	Ver.	φ <sub>H</sub>		40	50	--	
		φ <sub>L</sub>		55	65	--	

#### a. Test equipment setup

After stabilizing and leaving the panel alone shall be warmed up for the stable operation of LCM, the measurement should be executed. Measurement should be executed in a stable, windless, and dark room. Optical specifications are measured by Topcon BM-7(fast) with a viewing angle of 2° at a distance of 50cm and normal direction.

## Product Specification

	Model: GTTQ57SN762E0	Rev. No.	Issued Date.	Page.
		A	April. 30, 10	12 / 19

b. Definition of response time: Tr and Tf

The response time is defined as the following figure and shall be measured by switching the input signal for "black" and "white".

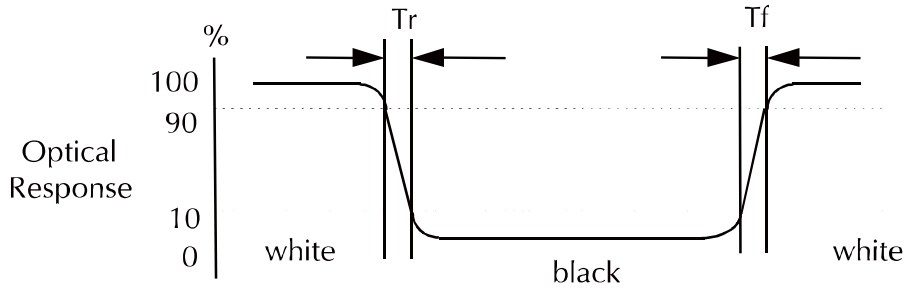

c. Definition of contrast ratio:

$$\text{Contrast Ratio (CR)} = \frac{\text{Brightness measured when LCD is at "white state"}}{\text{Brightness measured when LCD is at "black state"}}$$

d. Measured at the center area of the panel when all the input terminals of LCD panel are electrically opened.

## Product Specification

	Model: GTTQ57SN762E0	Rev. No.	Issued Date.	Page.
		A	April. 30, 10	13 / 19

e. View Angle

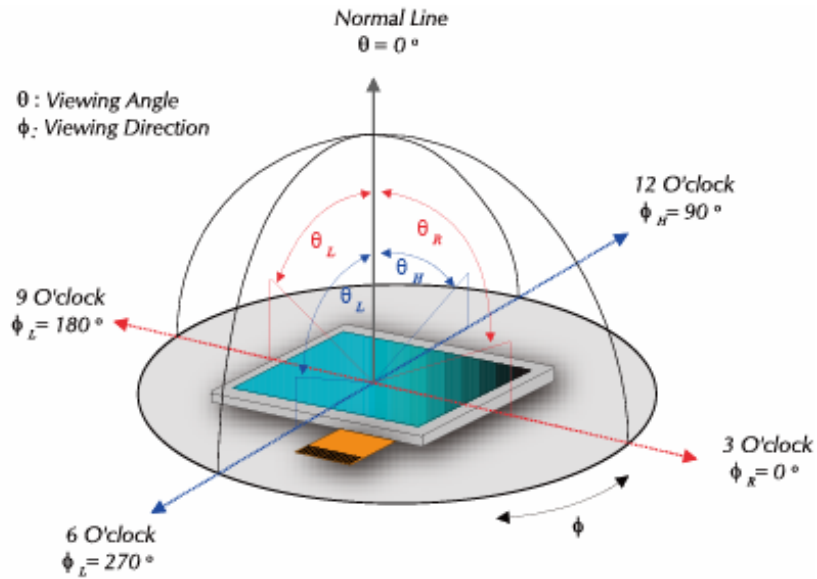

f. Definition of Luminance of White: Luminance of white at the center points

Light Source of Back-Light Unit	LED Type
---------------------------------	----------

g. Definition of White Uniformity

$$\text{White Uniformity} = \frac{\text{Min. luminance of white among 9-points}}{\text{Max. luminance of white among 9-points}}$$

h. The definition of Color Gamut -Color Chromaticity CIE 1931

Color coordinate of white & red, green, blue at center point.

Color Gamut : NTSC(%) = ( RGB Triangle Area / NTSC Triangle Area ) x 100

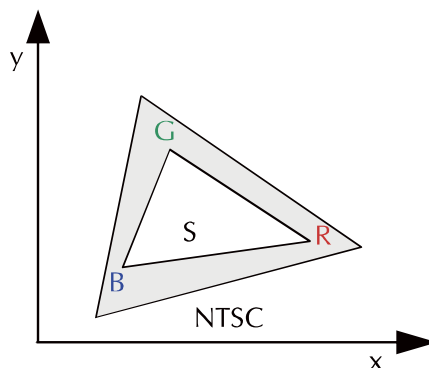

## Product Specification

	Model: GTTQ57SN762E0	Rev. No.	Issued Date.	Page.
		A	April. 30, 10	14 / 19

### 5. I/O Terminal

#### 5.1 Pin Assignment

Pin No.	Symbol	I/O	Function	Remark
1	DGND	--	GND	
2	DCLK	I	Clock signal for sampling each data signal	
3	Hsync	I	Horizontal synchronous signal (Negative)	
4	Vsync	I	Vertical synchronous signal (Negative)	
5	GND	I	GND	
6	R0	I	RED data signal (LSB)	
7	R1	I	RED data signal	
8	R2	I	RED data signal	
9	R3	I	RED data signal	
10	R4	I	RED data signal	
11	R5	I	RED data signal (MSB)	
12	GND	--	GND	
13	G0	I	GREEN data signal (LSB)	
14	G1	I	GREEN data signal	
15	G2	I	GREEN data signal	
16	G3	I	GREEN data signal	
17	G4	I	GREEN data signal	
18	G5	I	GREEN data signal (MSB)	
19	GND	--	GND	
20	B0	I	BLUE data signal(LSB)	
21	B1	I	BLUE data signal	
22	B2	I	BLUE data signal	
23	B3	I	BLUE data signal	
24	B4	I	BLUE data signal	
25	B5	I	BLUE data signal(MSB)	
26	GND	--	GND	
27	DEN	I	Signal to settle the horizontal display position (Positive)	Note5-1
28	VCC	--	3.3V power supply	
29	VCC	--	3.3V power supply	
30	LRC	I	Horizontal display mode select signal H: Normal L: Left / Right reverse mode	Note5-2
31	UDC	I	Vertical display mode select signal L: Normal H: Up / Down reverse mode	Note5-2
32	NC	--	No Connection	
33	GND	I	GND	



# Product Specification



Model: GTTQ57SN762E0

Rev. No.

Issued Date.

Page.

A

April. 30, 10

15 / 19

Note5 - 1 The horizontal display start timing is settled in accordance with a rising timing of ENAB signal. In case ENAB is fixed "Low", the horizontal start timing is determined. Don't keep ENAB "High" during operation.

Note 5 - 2

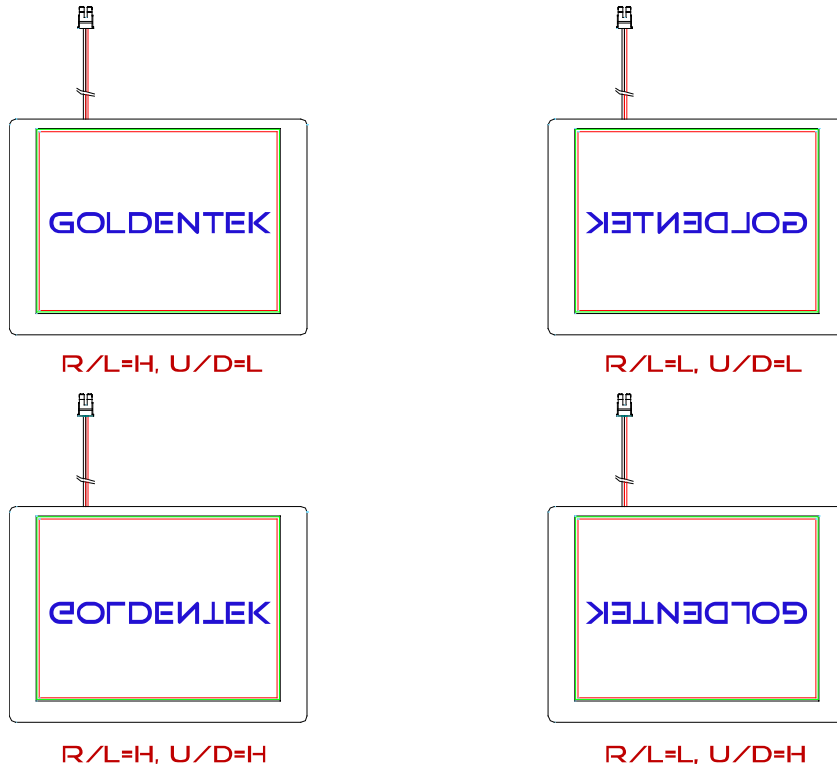

## Product Specification

	Model: GTTQ57SN762E0	Rev. No.	Issued Date.	Page.
		A	April. 30, 10	16 / 19

### 5.2 Block Diagram

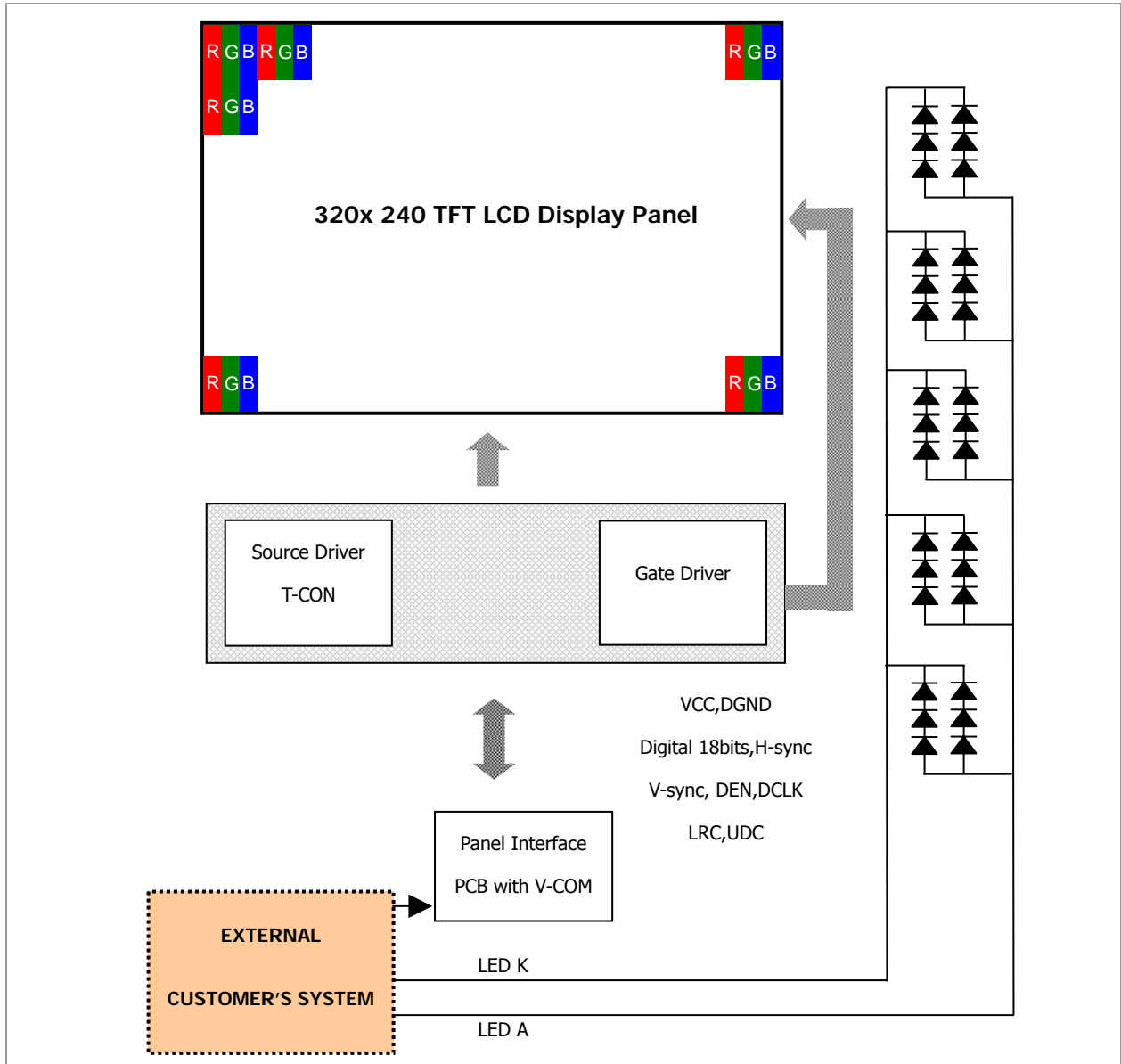

### 5.3 Back-light Unit (BLU)

Pin No.	Symbol	Function	Remark
1	LEDA	Power Supply for LED backlight	Red
2	LEDK	GND for LED backlight	Black

Connector: JST BHSR-02VS-1

## Product Specification

	Model: GTTQ57SN762E0	Rev. No.	Issued Date.	Page.
		A	April. 30, 10	17 / 19

### 5.4 Basic Display Color and Gray Scale

	Color & Gray Scale	Data Signal																	
		R5	R4	R3	R2	R1	R0	G5	G4	G3	G2	G1	G0	B5	B4	B3	B2	B1	B0
Basic Color	Black	0	0	0	0	0	0	0	0	0	0	0	0	0	0	0	0	0	0
	Red(0)	1	1	1	1	1	1	0	0	0	0	0	0	0	0	0	0	0	0
	Green(0)	0	0	0	0	0	0	1	1	1	1	1	1	0	0	0	0	0	0
	Blue(0)	0	0	0	0	0	0	0	0	0	0	0	0	1	1	1	1	1	1
	Cyan	0	0	0	0	0	0	1	1	1	1	1	1	1	1	1	1	1	1
	Magenta	1	1	1	1	1	1	0	0	0	0	0	0	1	1	1	1	1	1
	Yellow	1	1	1	1	1	1	1	1	1	1	1	1	0	0	0	0	0	0
	White	1	1	1	1	1	1	1	1	1	1	1	1	1	1	1	1	1	1
Red	Black	0	0	0	0	0	0	0	0	0	0	0	0	0	0	0	0	0	0
	Red(62)	0	0	0	0	0	1	0	0	0	0	0	0	0	0	0	0	0	0
	Red(61)	0	0	0	0	1	0	0	0	0	0	0	0	0	0	0	0	0	0
	:	:	:	:	:	:	:	:	:	:	:	:	:	:	:	:	:	:	:
	Red(31)	0	1	1	1	1	1	0	0	0	0	0	0	0	0	0	0	0	0
	:	:	:	:	:	:	:	:	:	:	:	:	:	:	:	:	:	:	:
	Red(1)	1	1	1	1	1	0	0	0	0	0	0	0	0	0	0	0	0	0
	Red(0)	1	1	1	1	1	1	0	0	0	0	0	0	0	0	0	0	0	0
Green	Black	0	0	0	0	0	0	0	0	0	0	0	0	0	0	0	0	0	0
	Green(62)	0	0	0	0	0	0	0	0	0	0	0	1	0	0	0	0	0	0
	Green(61)	0	0	0	0	0	0	0	0	0	0	1	0	0	0	0	0	0	0
	:	:	:	:	:	:	:	:	:	:	:	:	:	:	:	:	:	:	:
	Green(31)	0	0	0	0	0	0	0	1	1	1	1	0	0	0	0	0	0	0
	:	:	:	:	:	:	:	:	:	:	:	:	:	:	:	:	:	:	:
	Green(1)	0	0	0	0	0	0	1	1	1	1	1	0	0	0	0	0	0	0
	Green(0)	0	0	0	0	0	0	1	1	1	1	1	1	0	0	0	0	0	0
Blue	Black	0	0	0	0	0	0	0	0	0	0	0	0	0	0	0	0	0	0
	Blue(62)	0	0	0	0	0	0	0	0	0	0	0	0	0	0	0	0	0	1
	Blue(61)	0	0	0	0	0	0	0	0	0	0	0	0	0	0	0	0	1	0
	:	:	:	:	:	:	:	:	:	:	:	:	:	:	:	:	:	:	:
	Blue(31)	0	0	0	0	0	0	0	0	0	0	0	0	0	1	1	1	1	1
	:	:	:	:	:	:	:	:	:	:	:	:	:	:	:	:	:	:	:
	Blue(1)	0	0	0	0	0	0	0	0	0	0	0	0	1	1	1	1	1	0
	Blue(0)	0	0	0	0	0	0	0	0	0	0	0	0	1	1	1	1	1	1

Each basic color can be displayed in 64 gray scales from 6 bit data signals. With the combination of total 18 bit data signals, the 262,144-color display can be achieved on the screen.

## Product Specification

	Model: GTTQ57SN762E0	Rev. No.	Issued Date.	Page.
		A	April. 30, 10	18 / 19

### 6. Test

No change on display and in operation under the following test condition.

Condition: Unless otherwise specified, tests will be conducted under the following condition.

Temperature: 20±5°C.

Humidity: 65±5%RH.

Tests will be not conducted under functioning state.

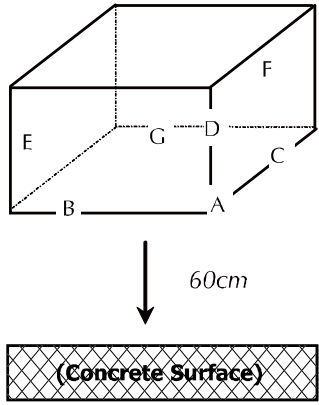
No.	Parameter	Condition	Notes
1	High Temperature Operating	70°C±2°C, 240hrs (Operation state).	-
2	Low Temperature Operating	-20°C±2°C, 240hrs (Operation state).	-
3	High Temperature Storage	80°C±2°C, 240hrs.	-
4	Low Temperature Storage	-30°C±2°C, 240hrs.	-
5	High Temperature and High Humidity Operation Test	60°C±2°C, 90%, 240hrs.	-
6	Vibration Test	Total fixed amplitude: 1.5mm. Vibration Frequency: 10~55Hz. One cycle 60 seconds to 3 direction of X, Y, Z each 15 minutes.	-
7.	Drop Test	To be measured after dropping from 60cm high on the concrete surface in packing state. 	-

# Product Specification



Model: GTTQ57SN762E0

Rev. No.

Issued Date.

Page.

A

April. 30, 10

19 / 19

## 7. Dimensional Outlines

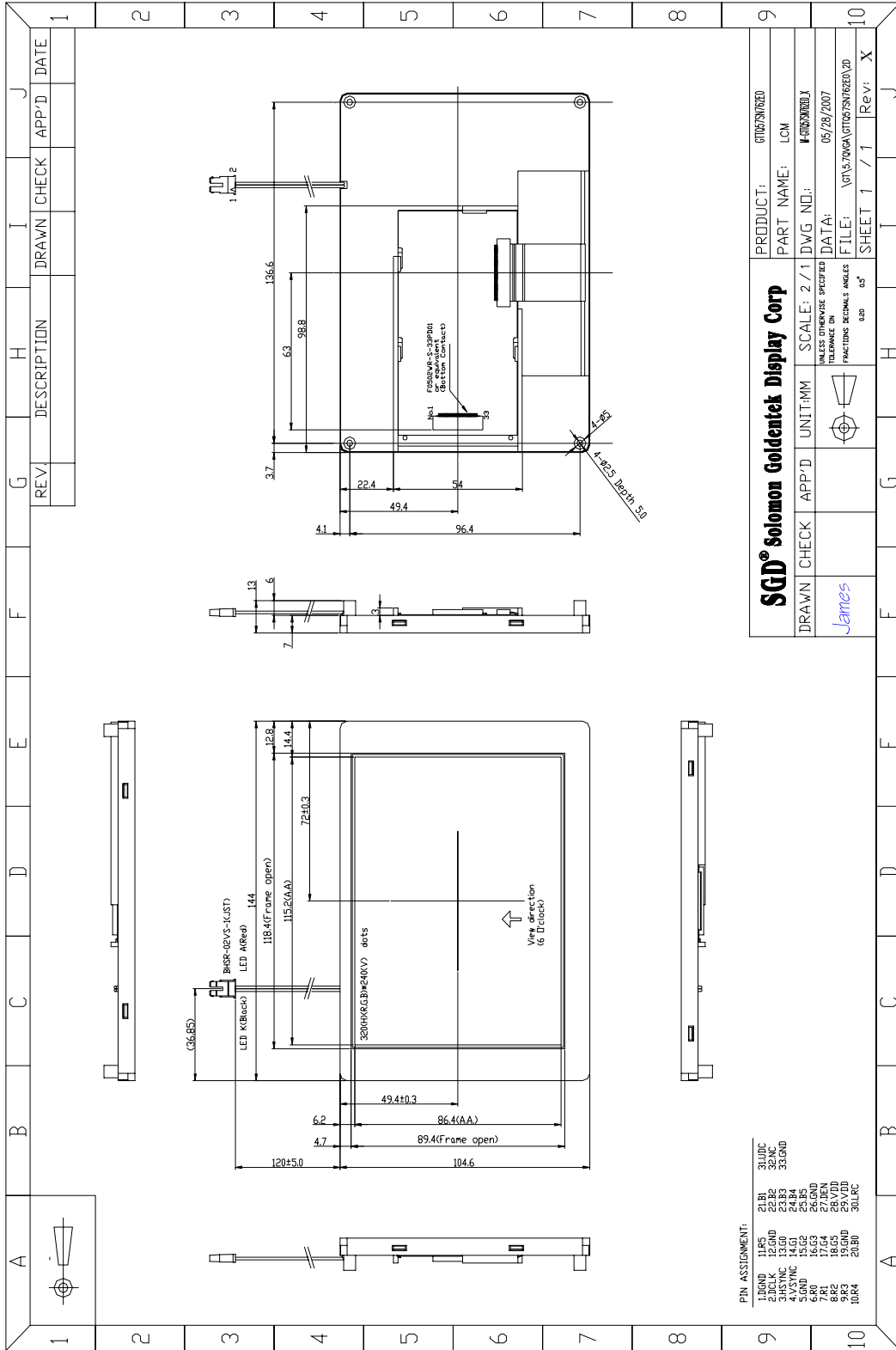

REV	DESCRIPTION	DRAWN	CHECK	APP'D	DATE

<b>SGD® Solomon Goldentek Display Corp</b>		PRODUCT:	GTTQ57SN762E0
DRAWN	CHECK	PART NAME:	LCM
James		DWG NO.:	#H19000001
		DATE:	05/28/2007
		FILE:	GTG15.700EA\GTTQ57SN762E0.D
		SHEET	1 / 1
		Rev:	X

UNIT:MM	SCALE: 2 / 1	DWG NO.:	#H19000001
		DATE:	05/28/2007
		FILE:	GTG15.700EA\GTTQ57SN762E0.D
		SHEET	1 / 1
		Rev:	X

PIN ASSIGNMENT:	21 IN	31 IN
1.0VDD	12P50	32AVC
2.0VDD	12P50	32AVC
3.0VDD	12P50	32AVC
4.0VDD	12P50	32AVC
5.0VDD	12P50	32AVC
6.0VDD	12P50	32AVC
7.0VDD	12P50	32AVC
8.0VDD	12P50	32AVC
9.0VDD	12P50	32AVC
10.0VDD	12P50	32AVC
11.0VDD	12P50	32AVC
12.0VDD	12P50	32AVC
13.0VDD	12P50	32AVC
14.0VDD	12P50	32AVC
15.0VDD	12P50	32AVC
16.0VDD	12P50	32AVC
17.0VDD	12P50	32AVC
18.0VDD	12P50	32AVC
19.0VDD	12P50	32AVC
20.0VDD	12P50	32AVC

Our company network supports you worldwide with offices in Germany, Austria, Switzerland, the UK and the USA. For more information please contact:

## Headquarters

### Germany



#### FORTEC Elektronik AG

Augsburger Str. 2b  
82110 Germering

Phone: +49 89 894450-0  
E-Mail: [info@fortecag.de](mailto:info@fortecag.de)  
Internet: [www.fortecag.de](http://www.fortecag.de)

## Fortec Group Members

### Austria



#### Distec GmbH Office Vienna

Nuschinggasse 12  
1230 Wien

Phone: +43 1 8673492-0  
E-Mail: [info@distec.de](mailto:info@distec.de)  
Internet: [www.distec.de](http://www.distec.de)

### Germany



#### Distec GmbH

Augsburger Str. 2b  
82110 Germering

Phone: +49 89 894363-0  
E-Mail: [info@distec.de](mailto:info@distec.de)  
Internet: [www.distec.de](http://www.distec.de)

### Switzerland



#### ALTRAC AG

Bahnhofstraße 3  
5436 Würenlos

Phone: +41 44 7446111  
E-Mail: [info@altrac.ch](mailto:info@altrac.ch)  
Internet: [www.altrac.ch](http://www.altrac.ch)

### United Kingdom



#### Display Technology Ltd.

Osprey House, 1 Osprey Court  
Hichingbrooke Business Park  
Huntingdon, Cambridgeshire, PE29 6FN

Phone: +44 1480 411600  
E-Mail: [info@displaytechnology.co.uk](mailto:info@displaytechnology.co.uk)  
Internet: [www.displaytechnology.co.uk](http://www.displaytechnology.co.uk)

### USA



#### Apollo Display Technologies, Corp.

87 Raynor Avenue,  
Unit 1 Ronkonkoma,  
NY 11779

Phone: +1 631 5804360  
E-Mail: [info@apolloDisplays.com](mailto:info@apolloDisplays.com)  
Internet: [www.apolloDisplays.com](http://www.apolloDisplays.com)