



OUR GLOBAL  
COMPETENCE  
CENTRES

 APOLLO DISPLAY  
TECHNOLOGIES



 DISTEC



 DISPLAY  
TECHNOLOGY



# Datasheet

## SGD

; ?±, \$BB87% \$

ÜÖËËËË



Product Specification				
	Model: GKIX80NNDC1F0	Rev. No.	Issued Date.	Page.
		A	2016, Jan. 06	1 / 24

Thin-Film-Transistor LCD Module  
Model: GKIX80NNDC1F0

Acceptance

**Solomon Goldentek Display Corp.**  
**NO. 18 Ta-Yeh St., Ta-Fa Industrial Park, Ta-Liao**  
**Hsiang, Kaohsiung Hsien 831, TAIWAN , R.O.C.**  
FAX: 886-7-7886800

Approved and Checked by

Approved by	Checked by		Made by
			



<b>Product Specification</b>			
	Model: GKIX80NNDC1F0	Rev. No.	Issued Date.
		A	2016, Jan. 06
			Page.
			3 / 24

## Contents

<b>1.</b>	<b>General Description and Features</b>	4
1.1	Features	4
1.2	LCD Module	4
<b>2.</b>	<b>Mechanical Information</b>	4
<b>3.</b>	<b>Electrical Specifications</b>	5
3.1	Absolute Max. Ratings	5
3.2	Timing Characteristics	8
3.3	Back-Light Unit	12
<b>4.</b>	<b>Optical Characteristics</b>	13
4.1	Optical characteristic of the LCD	13
<b>5.</b>	<b>I/O Terminal</b>	16
5.1	Pin Assignment (connector part No: MSB24013P20HA or equivalent.)	16
5.2	Back Light Unit (Connector Part No: JST:BHSR-02VS-01(N) or equivalent.)	17
5.3	Block Diagram	17
<b>6.</b>	<b>Displayed Color and Input Data</b>	18
<b>7.</b>	<b>Reliability Condition</b>	19
<b>8.</b>	<b>Dimensional Outlines</b>	20
<b>9.</b>	<b>Incoming Inspection Standards</b>	21

## Product Specification

	Model: GKIX80NNDC1F0	Rev. No.	Issued Date.	Page.
		A	2016, Jan. 06	4 / 24

### 1. General Description and Features

GKIX80NNDC1F0 is a Normally block TFT (Thin Film Transistor) liquid crystal display (LCD) that uses amorphous silicon TFT as a switching device. This model is composed of a TFT-LCD module, a receiver circuit and a back-light unit. Graphics and texts can be displayed on a XGA 1024 (W) x RGB x 768 (H) dots (4:3 aspect ratio) with 16.7M colors. The following table described the features of GKIX80NNDC1F0.

#### 1.1 Features

- Normally block and back-light with 28 LEDs are available.
- IPS
- LVDS Receiver 6/8 bit Interface
- ROHS Compliance

#### 1.2 LCD Module

Item	Specification	Unit
Screen Size	8.0 inches	Diagonal
Display Resolution	1024(H) x 768 (V)	Pixel
Active Area	162.048 (H) x 121.536 (V)	mm
Outline Dimension	183 (H) x 141 (V) x 5.8 (T)	mm
Display Mode	Normally block	--
Pixel Arrangement	R,G,B Vertical Stripe	--
Dot pitch	0.05275 x 0.15825	mm
Surface Treatment	Anti-Glare and Hard Coating(3H)	
Display Color	262K/16.7M	--
Viewing Direction	FREE	--
Input Interface	LVDS Receiver 6/8 bit Interface	--

### 2. Mechanical Information

Item	Min.	Typ.	Max.	Unit	Note
Module Size	Horizontal (H)	--	183	--	mm
	Vertical (V)	--	141	--	mm
	Thickness (T)	--	5.8	--	mm (1)
Weight	--	(250)	--	g	--

Note (1) Not Include Component. Refer to the Outline Dimension Drawing as attached.

## Product Specification

	Model: GKIX80NNDC1F0	Rev. No.	Issued Date.	Page.
		A	2016, Jan. 06	5 / 24

### 3. Electrical Specifications

#### 3.1 Absolute Max. Ratings

##### 3.1.1 Absolute Ratings of Environment

If the operating condition exceeds the following absolute maximum ratings, the TFT LCD module may be damaged permanently.

(Ta=25±2°C, V<sub>SS</sub>=GND=0)

Item	Symbol	Min.	Max.	Unit	Note
Storage temperature	T <sub>STG</sub>	-20	60	°C	(1)
Operating temperature	T <sub>OPR</sub>	-10	50	°C	(1,2,3)

Note (1) 95 % RH Max. ( 40 °C ≥ Ta ). Maximum wet-bulb temperature at 39 °C or less. (Ta > 40 °C) No condensation.

Note (2) In case of below 0°, the response time of liquid crystal (LC) becomes slower and the color of panel becomes darker than normal one. Level of retardation depends on temperature, because of LC's character

Note (3) Only operation is guaranteed at operating temperature. Contrast, response time, another display quality are evaluated at +25°C.

##### 3.1.2 Electrical Absolute Maximum Ratings

###### 3.1.2.1 TFT-LCD Module

(V<sub>SS</sub>=GND=0)

Parameter	Symbol	Min.	Max.	Unit	Remark
Power supply voltage	V <sub>CC</sub>	-0.3	5.0	V	
	A <sub>VDD</sub>	6.5	13.5	V	--
	V <sub>GH</sub>	-0.3	40	V	
	V <sub>GL</sub>	-20	0.3	V	
	V <sub>GH</sub> -V <sub>GL</sub>	-	40	V	

###### 3.1.2.2 Backlight Unit

(V<sub>SS</sub>=GND=0)

Parameter	Symbol	Min.	Max.	Unit	Remark
Current of Backlight Unit	IB	--	120	mA	
Voltage of Backlight Unit	VB	--	23.1	V	

## Product Specification

	Model: GKIX80NNDC1F0	Rev. No.	Issued Date.	Page.
		A	2016, Jan. 06	6 / 24

### 3.1.3 DC Electrical Characteristics of the TFT LCD

( $T_a=25\pm 2^{\circ}\text{C}$ ,  $V_{SS}=\text{GND}=0$ )

Item	Symbol	Min.	Typ.	Max.	Unit	Remark
Power supply	$V_{CC}$	3.0	3.3	3.6	V	Note 1
Input logic high voltage	$V_{IH}$	$0.7V_{CC}$	-	$V_{CC}$		
Input logic low voltage	$V_{IL}$	0	-	$0.3V_{CC}$		Note 2
Power Supply current	$I_{CC}$	-	(220)	(250)	mA	Note 3

Note1: VCC setting should match the signals output voltage (refer to Note 2) of customer' s system board

Note2 Typical Vcom is only a reference value, it must be optimized according to each LCM, please use VR and

base on below application circuit

Note3 RESET, STBYB, SELB, L/R, U/D, CABCE0, CABCE1



## Product Specification



Model: GKIX80NNDC1F0

Rev. No.

Issued Date.

Page.

A

2016, Jan. 06

7 / 24

### 3.1.4 Power Signal sequence

Power On

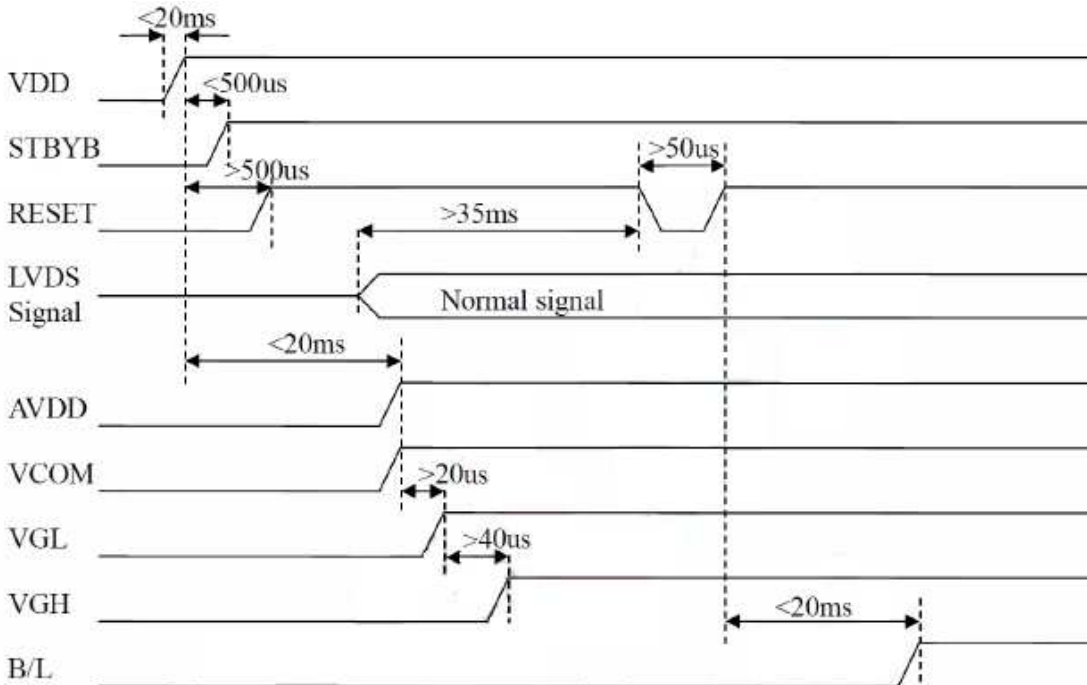

Power Off

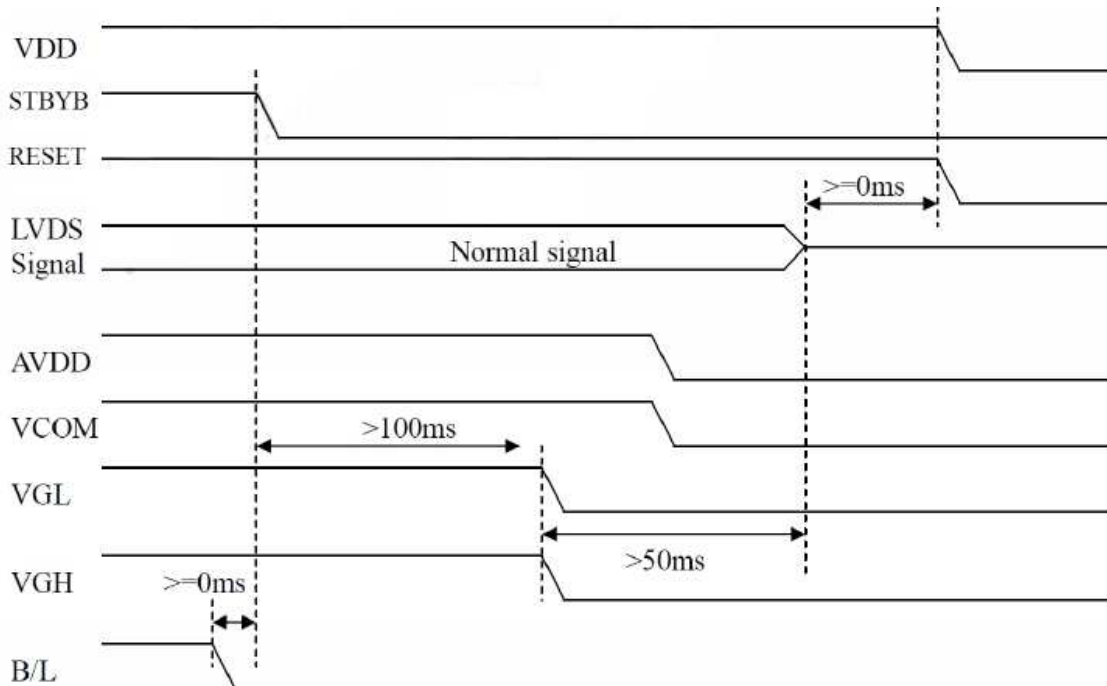

## Product Specification



Model: GKIX80NNDC1F0

Rev. No.

Issued Date.

Page.

A

2016, Jan. 06

8 / 24

### 3.2 Timing Characteristics

#### 3.2.1 AC Electrical Characteristics

Parameter	Symbol	Values			Unit.	Remark
		Min.	Typ.	Max.		
Clock Frequency	$R_{XFCLK}$	20	--	71	MHz	--
Input data skew margin	$T_{RSKM}$	500	--	--	Ps	--
Clock high time	$T_{LVCH}$	--	$4/(7 * R_{XFCLK})$	--	Ns	--
Clock low time	$T_{LVCL}$	--	$3/(7 * R_{XFCLK})$	--	ns	--

#### 3.2.2 Input Clock and Data Timing Diagram

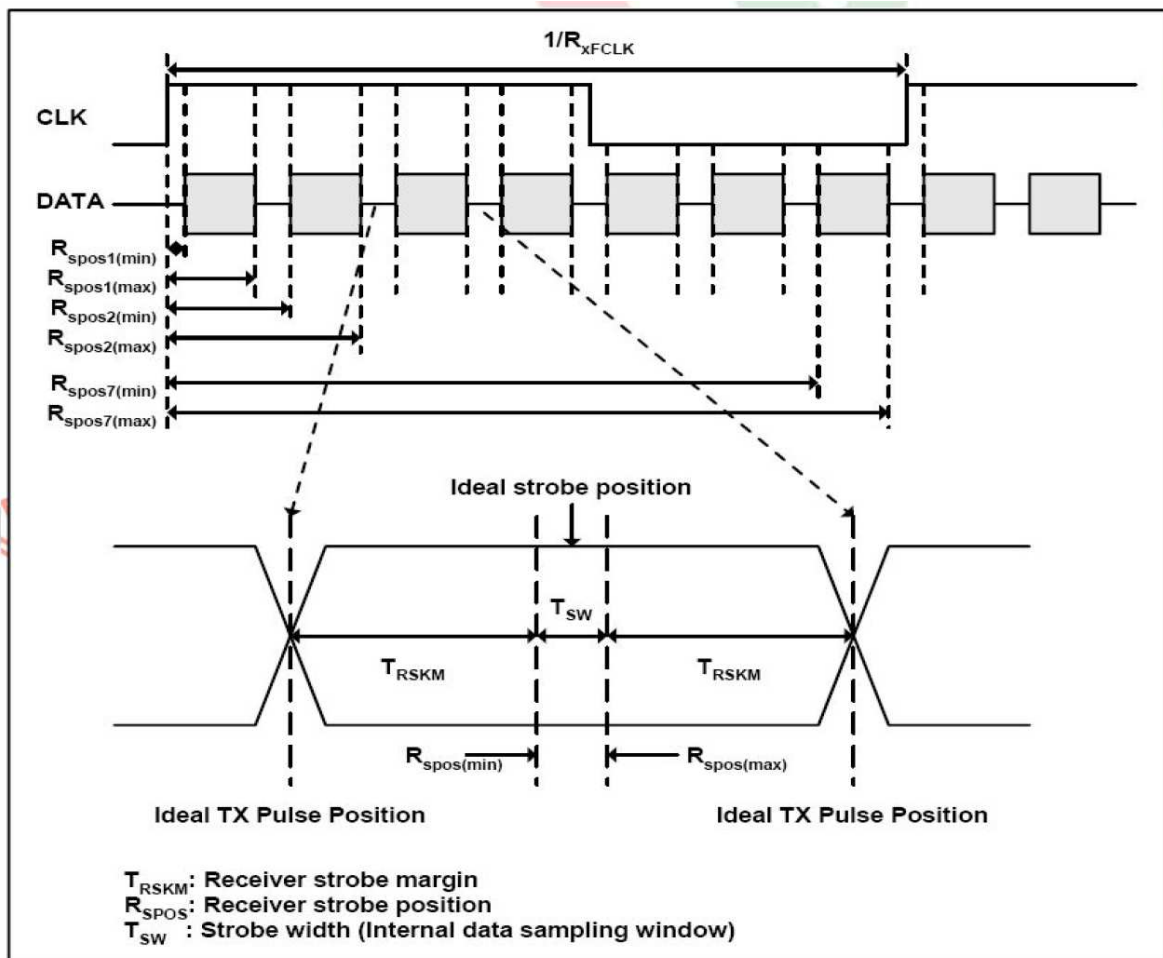

## Product Specification



Model: GKIX80NNDC1F0

Rev. No.

Issued Date.

Page.

A

2016, Jan. 06

9 / 24

### 3.2.3 DC Electrical Characteristics

Parameter	Symbol	Values			Unit.	Remark
		Min.	Typ.	Max.		
Differential input high Threshold voltage	$R_{xVTH}$	--	--	+0.1	V	$R_{xVCM}=1.2V$
Differential input low Threshold voltage	$R_{xVTL}$	-0.1	--	--	V	
Input voltage range (singled-end)	$R_{xVIN}$	0	--	2.4	V	--
Differential input common mode voltage	$R_{xVCM}$	$ VID /2$	--	$2.4- VID /2$	V	--
Differential voltage	$ VID $	0.2	--	0.6	V	--
Differential input leakage current	$R_{VxIz}$	-10	--	+10	$\mu A$	--

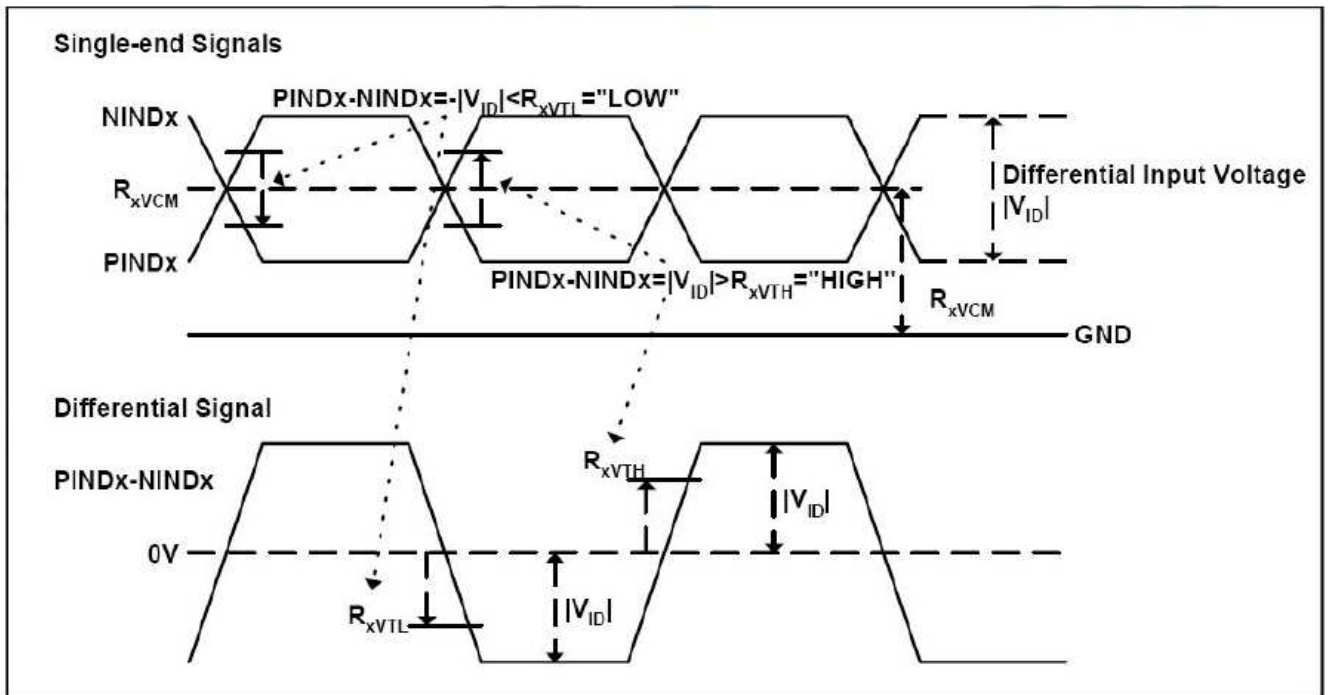

## Product Specification

	Model: GKIX80NNDC1F0	Rev. No.	Issued Date.	Page.
		A	2016, Jan. 06	10 / 24

### 3.2.4 Timing

Item	Symbol	Min.	Typ.	Max.	Unit.	Remark
Clock Frequency	$f_{clk}$	52	65	71	MHz	
Horizontal display area	$t_{hd}$	1024			DCLK	
HS period time	$T_h$	1114	1344	1400	DCLK	
HS Blanking	$T_{hb}+t_{hfp}$	90	320	376	DCLK	
Vertical display area	$T_{vd}$	768			H	
VS period time	$t_{vd}$	778	806	845	H	
VS Blanking	$T_{vb}+t_{vfp}$	10	38	77	H	

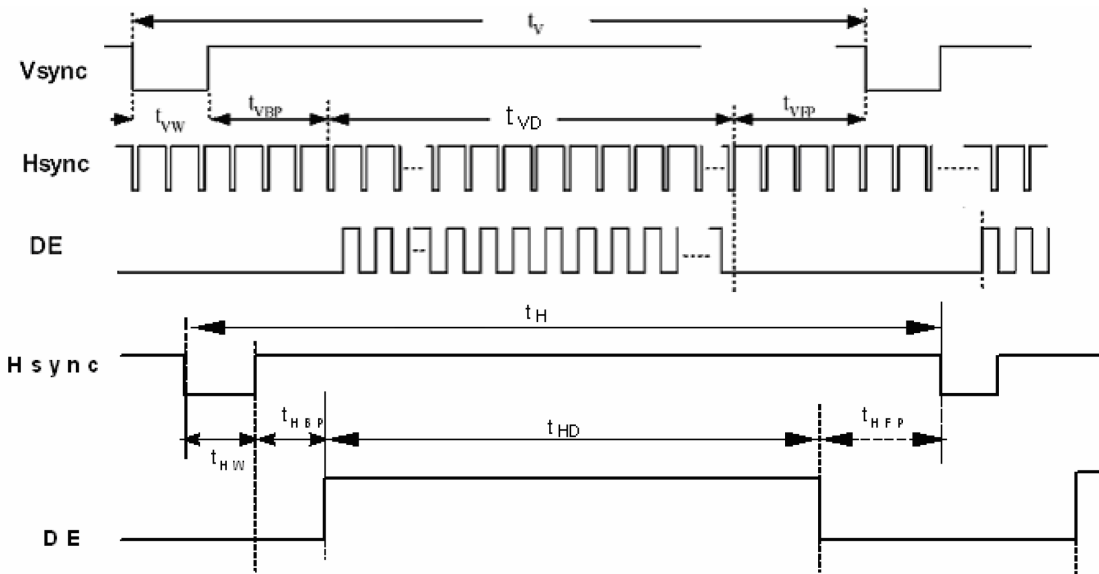

# Product Specification



Model: GKIX80NNDC1F0

Rev. No.

Issued Date.

Page.

A

2016, Jan. 06

11 / 24

## Data input Format

### 6bit LVDS input

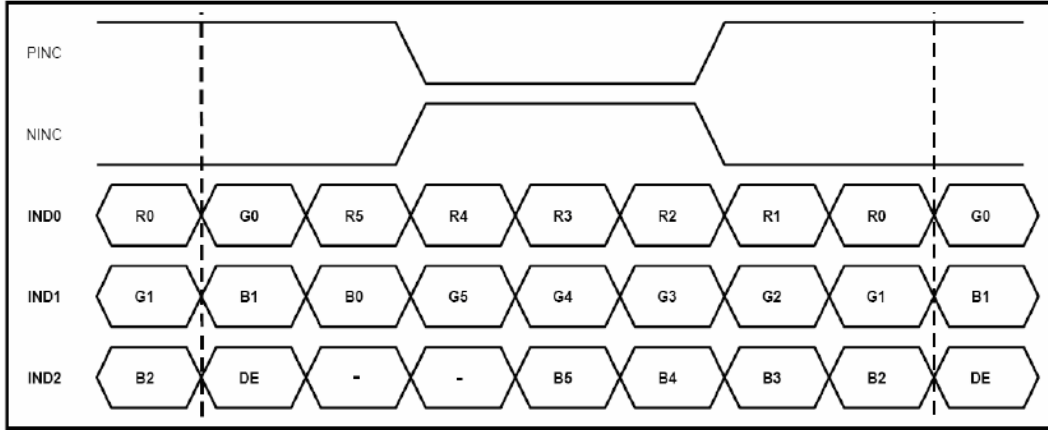

### 8bit LVDS input

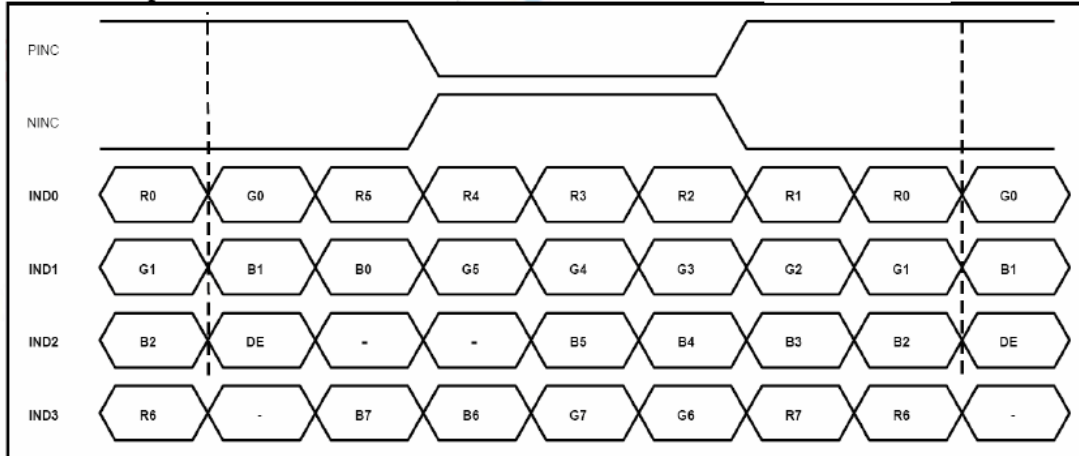

Note: Support DE timing mode only, SYNC mode not supported.

## Product Specification

	Model: GKIX80NNDC1F0	Rev. No.	Issued Date.	Page.
		A	2016, Jan. 06	12 / 24

### 3.3 Back-Light Unit

The Back-light system is an edge-lighting type with 28 white LED (Light Emitting Diode)s. The characteristics of 28 white LEDs are shown in the following tables.

(Ta= Room Temp)

Characteristics	Symbol	Min.	Typ.	Max.	Unit	Note
Forward Voltage	VB	21	23.1	24.5	V	
Forward Current	IB	-	120	-	mA	(1)
Power Consumption	P <sub>BL</sub>	-	2.772	-	W	(2)
LED life time	-	(40000)	-	-	hr	(3)

Note (1) LEDs in 7series x 4 parallel type.

(2) Where  $IB = 120\text{mA}$ ,  $VB = 23.1$ ,  $P_{BL} = VB \times IB$

(3) The environmental conducted under ambient air flow ,at  $Ta=25\pm 2^{\circ}\text{C}$ ,  $60\%RH\pm 5\%$

## Product Specification

	Model: GKIX80NNDC1F0	Rev. No.	Issued Date.	Page.
		A	2016, Jan. 06	13 / 24

### 4. Optical Characteristics

#### 4.1 Optical characteristic of the LCD

The following items are measured under stable conditions. The optical characteristics should be measured in a dark room or equivalent state with the methods.

Measuring equipment: BM-7A

Item	Symbol	Condition	Min	Type	Max	Unit	Note
Brightness	B		(350)	(400)	--	cd/m <sup>2</sup>	
Response time	T <sub>r</sub>	θ=0°	--	10	20	ms	.
	T <sub>f</sub>		--	20	30	ms	
Contrast ratio	CR	At optimized viewing angle	600	800	--	--	
Luminance Uniformity	ΔL		70	75		%	
Color Chromaticity (CIE 1931)	White	W <sub>x</sub>	(0.260)	(0.310)	(0.360)	--	BM-7A
		W <sub>y</sub>	(0.280)	(0.330)	(0.380)		
Viewing Angle (6H)	Hor.	θ <sub>R</sub>	CR≥10	75	85	--	Degree
		θ <sub>L</sub>		75	85	--	
	Ver.	θ <sub>U</sub>		75	85	--	
		θ <sub>D</sub>		75	85	--	

## Product Specification

	Model: GKIX80NNDC1F0	Rev. No.	Issued Date.	Page.
		A	2016, Jan. 06	14 / 24

a. Test equipment setup

After stabilizing and leaving the panel alone shall be warmed up for the stable operation of LCM, the measurement should be executed. Measurement should be executed in a stable, windless, and dark room. Optical specifications are measured by Topcon BM-7(fast) with a viewing angle of 2° at a distance of 50cm and normal direction.

b. Definition of response time: Tr and Tf

The response time is defined as the following figure and shall be measured by switching the input signal for "black" and "white".

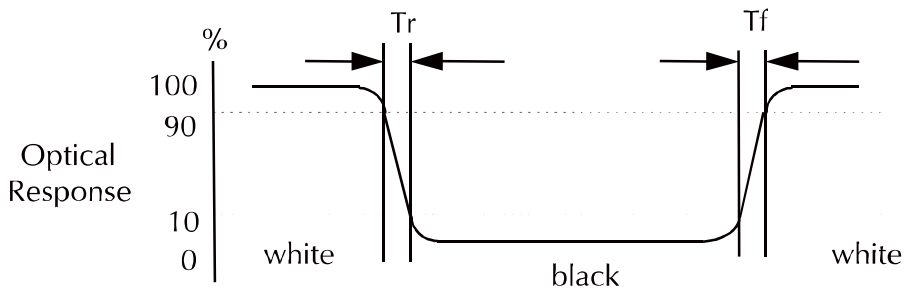

c. Definition of contrast ratio:

$$\text{Contrast Ratio (CR)} = \frac{\text{Brightness measured when LCD is at "white state"}}{\text{Brightness measured when LCD is at "black state"}}$$

d. Measured at the center area of the panel when all the input terminals of LCD panel are electrically opened.



## Product Specification



Model: GKIX80NNDC1F0

Rev. No.

Issued Date.

Page.

A

2016, Jan. 06

15 / 24

e. View Angle

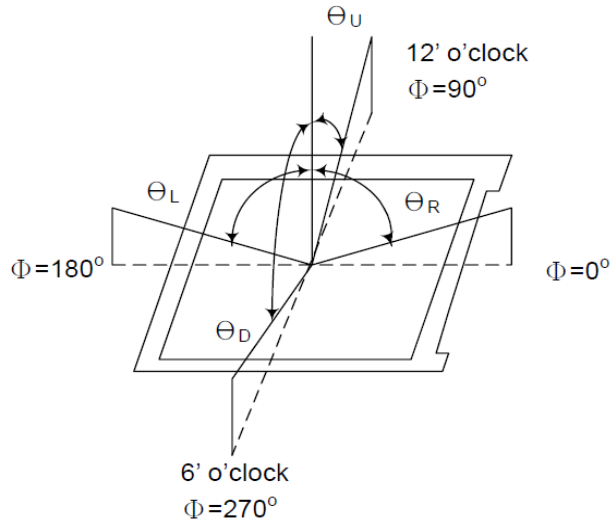

f. Definition of Luminance of White: Luminance of white at the center points

Light Source of Back-Light Unit	LED Type
---------------------------------	----------

g. Definition of White Uniformity

$$\text{White Uniformity} = \frac{\text{Min. luminance of white among 9-points}}{\text{Max. luminance of white among 9-points}} \times 100\%$$

## Product Specification



Model: GKIX80NNDC1F0

Rev. No.

Issued Date.

Page.

A

2016, Jan. 06

16 / 24

### 5. I/O Terminal

#### 5.1 Pin Assignment (connector part No: MSB24013P20HA or equivalent.)

Pin No.	Symbol	I/O	Function	Remark
1	VCC	P	Power Supply +3.3V	
2	VCC	P	Power Supply +3.3V	
3	SELB	P	6bit/8bit mode select	
4	GND	P	Ground	
5	RXIN0-	I	Negative LVDS differential data input	
6	RXIN0+	I	Positive LVDS differential data input	
7	GND	P	Ground	
8	RXIN1-	I	Negative LVDS differential data input	
9	RXIN1+	I	Positive LVDS differential data input	
10	GND	P	Ground	
11	RXIN2-	I	Negative LVDS differential data input	
12	RXIN2+	I	Positive LVDS differential data input	
13	GND	P	Ground	
14	CLK-	I	Negative LVDS differential clock input	
15	CLK+	I	Positive LVDS differential clock input	
16	GND	P	Ground	
17	RXIN3-	I	Negative LVDS differential data input	
18	RXIN3+	I	Positive LVDS differential data input	
19	GND	P	Ground	
20	GND	P	Ground	

I: Input, P: Power

Notes:

- 1) NC Pin must be retained; this pin can't contact GND or other signal.
- 2) If LVDS input data is 6 bits ,SELB must be set to High;  
If LVDS input data is 8 bits ,SELB must be set to Low.

## Product Specification



Model: GKIX80NNDC1F0

Rev. No.

Issued Date.

Page.

A

2016, Jan. 06

17 / 24

### 5.2 Back Light Unit (Connector Part No: JST:BHSR-02VS-01(N) or equivalent.)

Pin No.	Symbol	Function	Remark
1	LEDA	Power Supply for LED backlight	RED
2	LEDK	GND for LED backlight	BLACK

### 5.3 Block Diagram

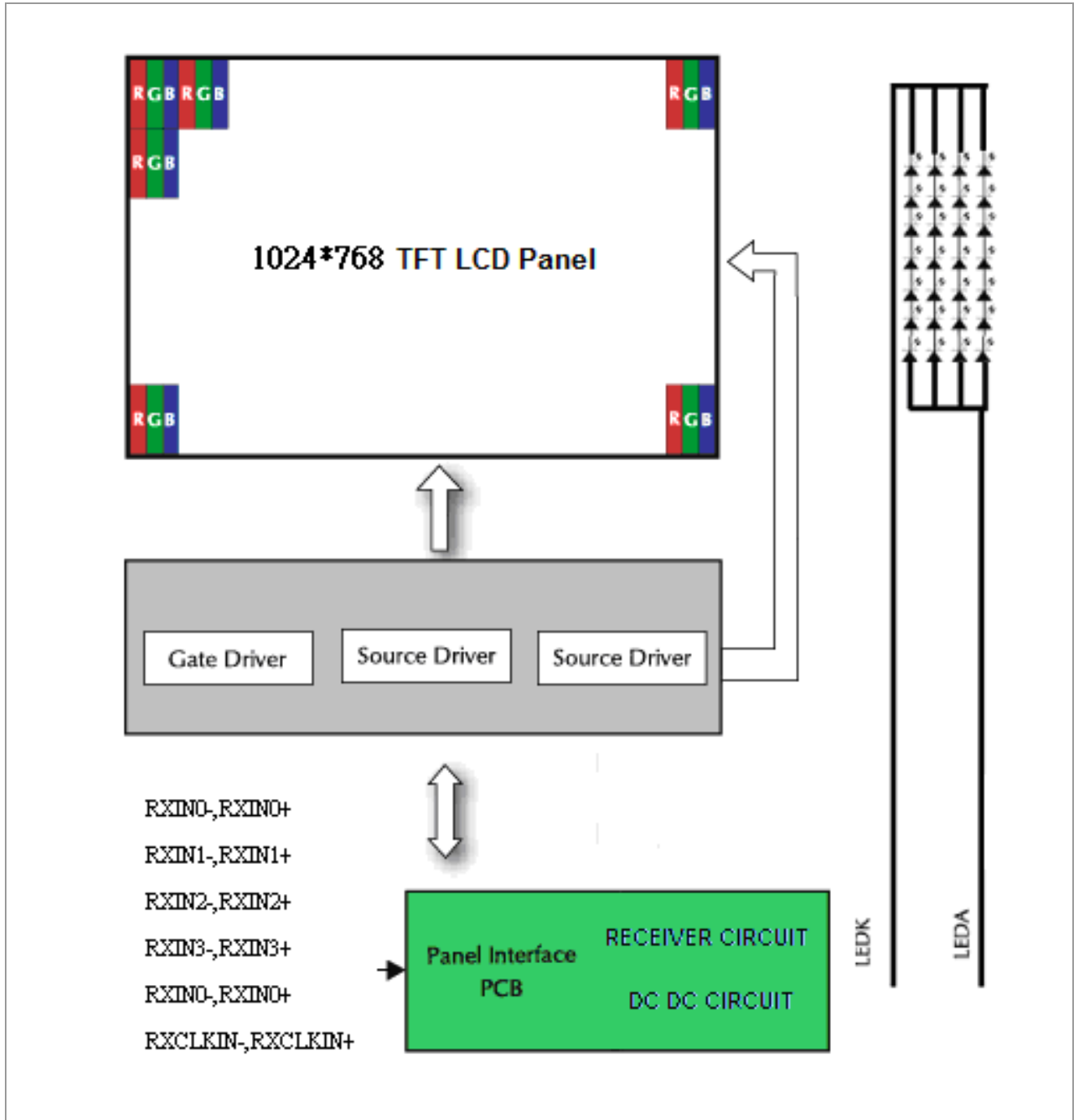

## Product Specification

	Model: GKIX80NNDC1F0	Rev. No.	Issued Date.	Page.
		A	2016, Jan. 06	18 / 24

### 6. Displayed Color and Input Data

	Color & Gray Scale	Data Signal																	
		R5	R4	R3	R2	R1	R0	G5	G4	G3	G2	G1	G0	B5	B4	B3	B2	B1	B0
Basic Color	Black	0	0	0	0	0	0	0	0	0	0	0	0	0	0	0	0	0	0
	Red(0)	1	1	1	1	1	1	0	0	0	0	0	0	0	0	0	0	0	0
	Green(0)	0	0	0	0	0	0	1	1	1	1	1	1	0	0	0	0	0	0
	Blue(0)	0	0	0	0	0	0	0	0	0	0	0	0	1	1	1	1	1	1
	Cyan	0	0	0	0	0	0	1	1	1	1	1	1	1	1	1	1	1	1
	Magenta	1	1	1	1	1	1	0	0	0	0	0	0	1	1	1	1	1	1
	Yellow	1	1	1	1	1	1	1	1	1	1	1	1	0	0	0	0	0	0
	White	1	1	1	1	1	1	1	1	1	1	1	1	1	1	1	1	1	
Red	Black	0	0	0	0	0	0	0	0	0	0	0	0	0	0	0	0	0	
	Red(62)	0	0	0	0	0	1	0	0	0	0	0	0	0	0	0	0	0	
	Red(61)	0	0	0	0	1	0	0	0	0	0	0	0	0	0	0	0	0	
	:	:	:	:	:	:	:	:	:	:	:	:	:	:	:	:	:	:	
	Red(31)	0	1	1	1	1	1	0	0	0	0	0	0	0	0	0	0	0	
	:	:	:	:	:	:	:	:	:	:	:	:	:	:	:	:	:	:	
	Red(1)	1	1	1	1	1	0	0	0	0	0	0	0	0	0	0	0	0	
Red(0)	1	1	1	1	1	1	0	0	0	0	0	0	0	0	0	0	0		
Green	Black	0	0	0	0	0	0	0	0	0	0	0	0	0	0	0	0	0	
	Green(62)	0	0	0	0	0	0	0	0	0	0	1	0	0	0	0	0	0	
	Green(61)	0	0	0	0	0	0	0	0	0	0	1	0	0	0	0	0	0	
	:	:	:	:	:	:	:	:	:	:	:	:	:	:	:	:	:	:	
	Green(31)	0	0	0	0	0	0	0	1	1	1	1	0	0	0	0	0	0	
	:	:	:	:	:	:	:	:	:	:	:	:	:	:	:	:	:	:	
	Green(1)	0	0	0	0	0	0	1	1	1	1	1	0	0	0	0	0	0	
Green(0)	0	0	0	0	0	0	1	1	1	1	1	1	0	0	0	0	0		
Blue	Black	0	0	0	0	0	0	0	0	0	0	0	0	0	0	0	0	0	
	Blue(62)	0	0	0	0	0	0	0	0	0	0	0	0	0	0	0	0	1	
	Blue(61)	0	0	0	0	0	0	0	0	0	0	0	0	0	0	0	0	1	
	:	:	:	:	:	:	:	:	:	:	:	:	:	:	:	:	:	:	
	Blue(31)	0	0	0	0	0	0	0	0	0	0	0	0	0	1	1	1	1	
	:	:	:	:	:	:	:	:	:	:	:	:	:	:	:	:	:	:	
	Blue(1)	0	0	0	0	0	0	0	0	0	0	0	0	1	1	1	1	0	
Blue(0)	0	0	0	0	0	0	0	0	0	0	0	0	1	1	1	1	1		

0 : Low level voltage, 1 :High level voltage

Each basic color can be displayed in 64 gray scales from 6 bit data signals. With the combination of total 18 bit data signals, the 262,144-color display can be achieved on the screen.

## Product Specification

	Model: GKIX80NNDC1F0	Rev. No.	Issued Date.	Page.
		A	2016, Jan. 06	19 / 24

### 7. Reliability Condition

No change on display and in operation under the following test condition.

Condition: Unless otherwise specified, tests will be conducted under the following condition.

Temperature:  $20 \pm 5^\circ\text{C}$ .

Humidity:  $65 \pm 5\% \text{RH}$ .

Tests will be not conducted under functioning state.

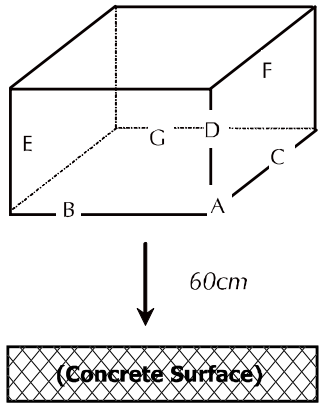
No.	Parameter	Condition	Notes
1	High Temperature Operating	$60^\circ\text{C} \pm 2^\circ\text{C}$ , 240hrs (Operation state).	
2	Low Temperature Operating	$-20^\circ\text{C} \pm 2^\circ\text{C}$ , 240hrs (Operation state).	1
3	High Temperature Storage	$50^\circ\text{C} \pm 2^\circ\text{C}$ , 240hrs.	2
4	Low Temperature Storage	$-10^\circ\text{C} \pm 2^\circ\text{C}$ , 240hrs.	1,2
5	High Temperature and High Humidity Operation Test	$4^\circ\text{C} \pm 2^\circ\text{C}$ , 90%, 240hrs.	1,2
6	Vibration Test	Total fixed amplitude: 1.5mm. Vibration Frequency: 10~55Hz. One cycle 60 seconds to 3 direction of X, Y, Z each 15 minutes.	3
7.	Drop Test	To be measured after dropping from 60cm high on the concrete surface in packing state.   <div style="margin-left: 20px;"> <p><i>Dropping method corner dropping:</i></p> <p><i>A corner: Once edge dropping.</i></p> <p><i>B, C, D edge: Once face dropping.</i></p> <p><i>E, F, G face: Once.</i></p> </div>	

- Notes:
1. No dew condensation to be observed.
  2. The function test shall be conducted after 4 hours storage at the normal temperature and humidity after removed from the test chamber.
  3. Vibration test will be conducted to the product itself without putting I in a container.

**Product Specification**

**8. Dimensional Outlines**

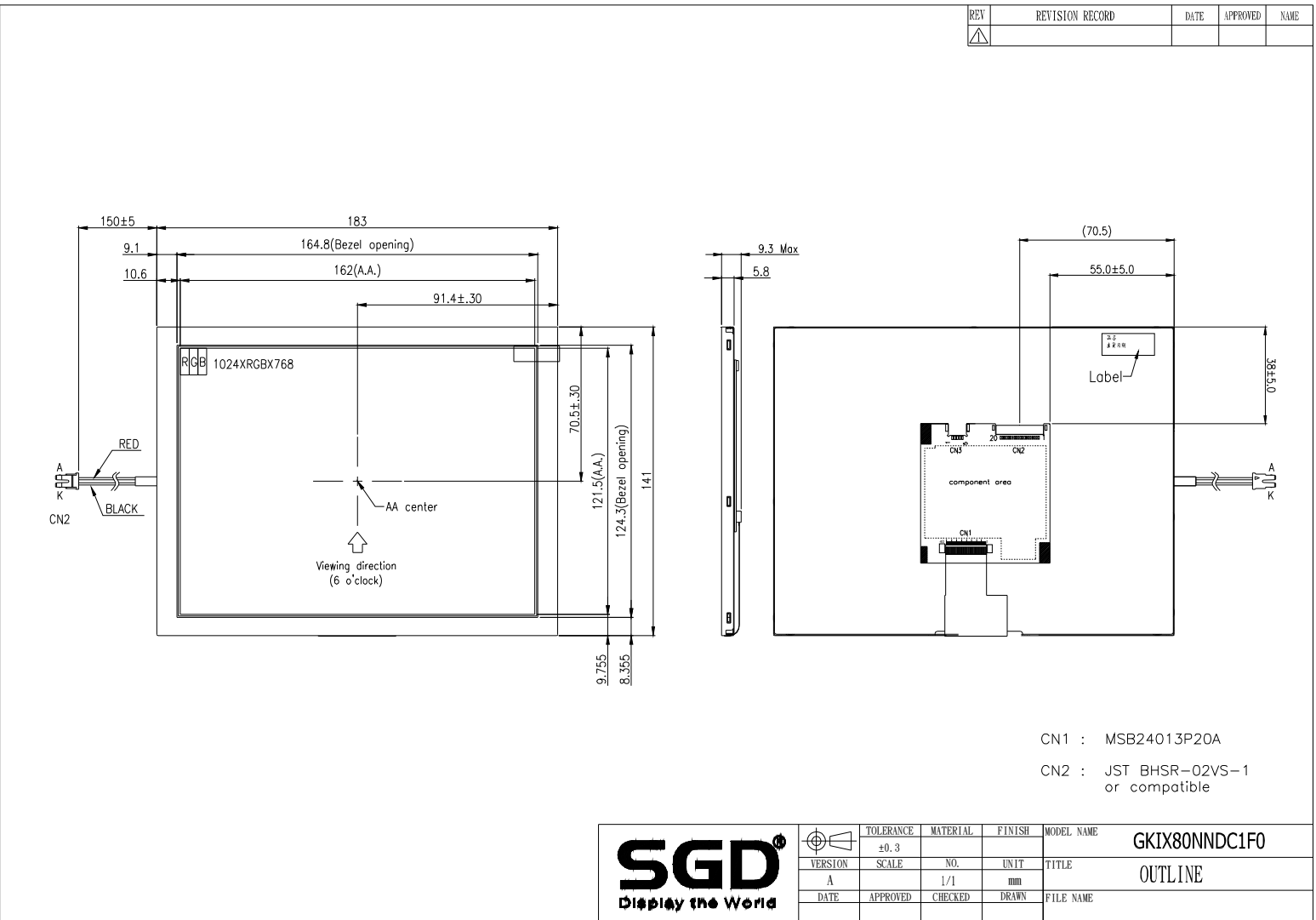

Product Specification				
	Model: GKIX80NNDC1F0	Rev. No.	Issued Date.	Page.
		A	2016, Jan. 06	21 / 24

**9. Incoming Inspection Standards**

9.1 Inspection and Environment Conditions

9.1.1 Inspection Conditions:

- (1) Inspection Distance: 35 cm±5cm
- (2) View Angle : Light-on Inspection Angle : ±5°  
Cosmetic Inspection Angle : ±45°

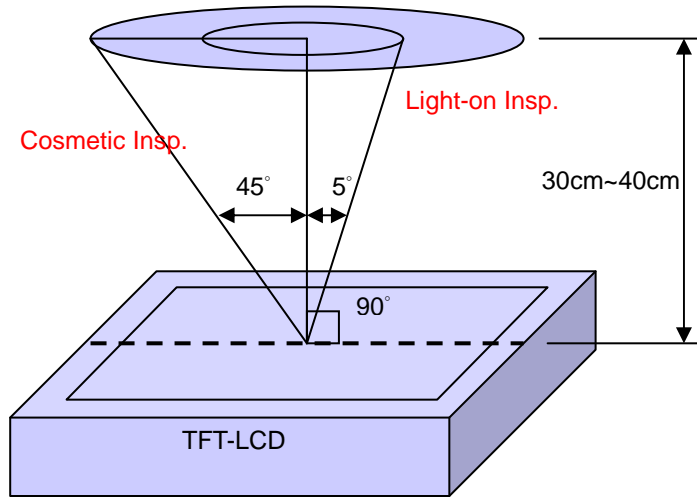

( perpendicular to LCD panel surface)

9.1.2 Environment Conditions:

Ambient Temperature		23°C ±5°C
Ambient Humidity		55±10%RH
Ambient Illumination	Cosmetic Inspection	more than 600 Lux
	Functional Inspection	300~500 Lux

9.1.3 Sampling Conditions:

- (1) Lot Size: Quantity of shipment lot per model
- (2) Sampling Method:

Sampling Plan		MIL-STD-105E
		Normal Inspection, Single Sampling
		Level II
AQL	Major Defect	1.0%
	Minor Defect	1.5%

- (3) The classification of Major(MA) and Minor(MI) defects is shown as 3. Inspection Criteria.

## Product Specification

	Model: GKIX80NNDC1F0	Rev. No.	Issued Date.	Page.
		A	2016, Jan. 06	22 / 24

### 9.1.4 Inspection Criteria

#### 9.1.4.1 Cosmetic Inspection(Panel):

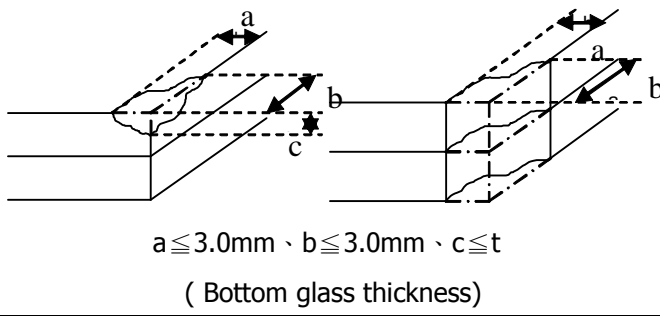
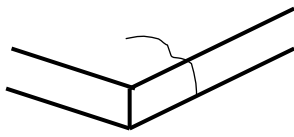
Item	Judgment Criteria	Classification
Chipping on Panel	 <p style="text-align: center;"><math>a \leq 3.0\text{mm}</math> · <math>b \leq 3.0\text{mm}</math> · <math>c \leq t</math> ( Bottom glass thickness)</p>	MA
Scratch on Panel *Note-2	$W \leq 0.05\text{mm}$ or $L < 5\text{mm}$ : Ignored $0.05\text{mm} < W \leq 0.1\text{mm}$ and $L \leq 5\text{mm}$ : $N \leq 5$ $W > 0.1\text{mm}$ or $L > 5\text{mm}$ : Not allowed	MI
Bubble or Dent on Panel *Note-3	$D \leq 0.2\text{mm}$ : Ignored $0.2\text{mm} < D \leq 0.3\text{mm}$ : $N \leq 5$ $D > 0.3\text{mm}$ : Not allowed	MI
Panel Crack	 <p style="text-align: center;">Not Allowed crack</p>	MA
Bezel Deformation	Obvious deformation is not allowed.	MI
Bezel Oxidation	Not allowed if it rusts continuously over 1 cm (It is out of warranty with rusted tin plate)	MI
Bezel Scratch	$L \leq 20\text{mm}$ , $W \leq 0.2$ , $N \leq 3$	MI
Metal Squash Dent /Flange(Front Side)	$D(W) \leq 1, L \leq 3, N \leq 3;$	MI
B/L High Voltage Wire Denudation	Not allowed	MA
Polarizer flaw or leak out resin	Defect is defined as the active area.	MI
Outline Dimension	Must in Spec, refer to related product spec.	MI



## Product Specification

	Model: GKIX80NNDC1F0	Rev. No.	Issued Date.	Page.
		A	2016, Jan. 06	23 / 24

### 9.1.4.2 Functional Inspection:

Item	Judgment Criteria			Classification
	Area(Note1)	I	O	
Point Defect	Bright dot	Random	2	
		2 dots adjacent	0	0
		3 dots adjacent or more	0	0
	Dark dot	Random	3	
		2 dots adjacent	1	
		3 dots adjacent or more	0	0
	Total Dot Defect		5	
	Distance	Distance between Bright and Bright dot	$L \geq 5\text{mm}$	
		Distance between Bright and Dark dot	$L \geq 5\text{mm}$	
		Distance between Dark dot	$L \geq 5\text{mm}$	
(1) It is defined as Point Defect if defect area $> 0.5\text{dot}$ (2) It is ignored if defect area $\leq 0.5\text{dot}$ (3) Weak point defect will be defined as Bright Dot if it can be observed through ND filter 5% ( Full Screen Black Inspection)				
Line Defect	Obvious vertical or horizontal line defect is not allowed.			MA
Mura	Not allowed if it can be observed through ND Filter 5 %			MI
Foreign Material in spot shape *Note-3	$D \leq 0.2\text{mm}$ : Ignored $0.2\text{mm} < D \leq 0.5\text{mm}$ : $N \leq 8$ $D > 0.5\text{mm}$ : Not allowed			MI
Foreign Material in line or spiral shape *Note-4	$W \leq 0.05\text{mm}$ or $L \leq 5\text{mm}$ : Ignored $0.05\text{mm} < W \leq 0.2\text{mm}$ and $L 1.0\text{mm} \leq 5\text{mm}$ : $N \leq 8$ $W > 0.2\text{mm}$ or $L > 5\text{mm}$ : Not allowed			MI
Display Function Abnormal	No Malfunction can be allowed			MA

# Product Specification



Model: GKIX80NNDC1F0

Rev. No.

Issued Date.

Page.

A

2016, Jan. 06

24 / 24

Note-1 : I/O Area Definition

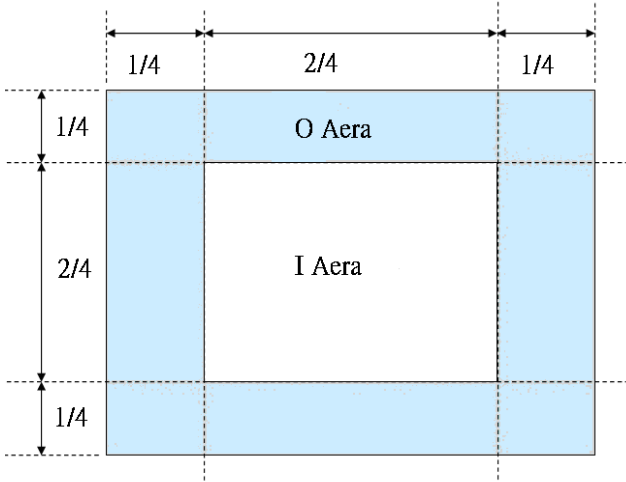

Note-2 : Polarizer Scratch

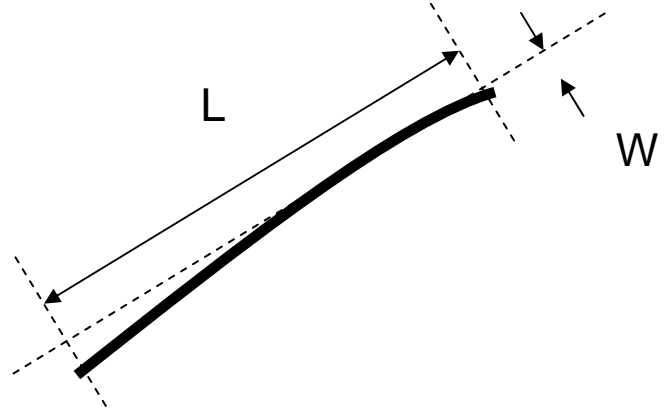

Note-3 : Spot Foreign Material  
( $W \geq L / 4$ )

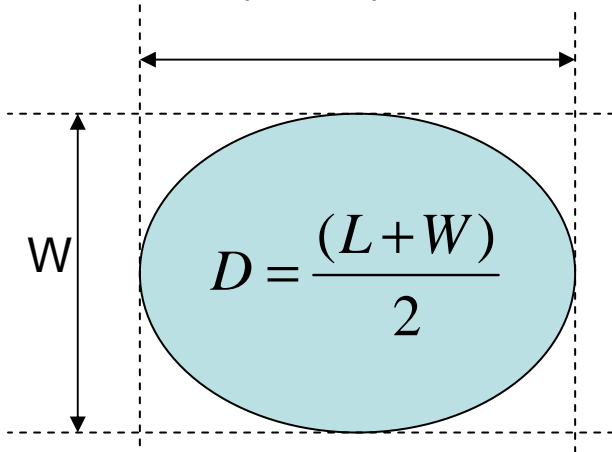

Note-4 : Line or Spiral Foreign Material  
( $W < L / 4$ )

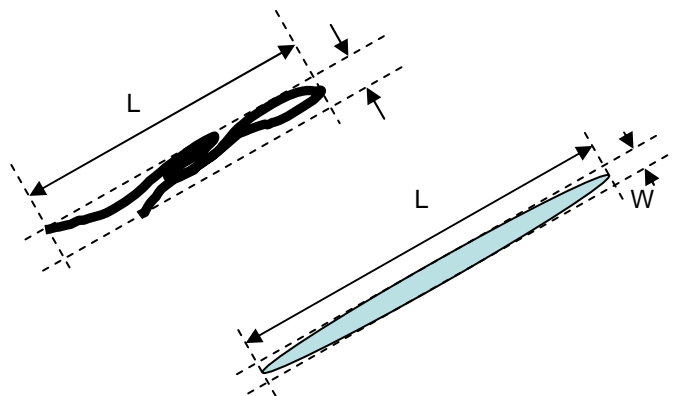

Our company network supports you worldwide with offices in Germany, Austria, Switzerland, the UK and the USA. For more information please contact:

## Headquarters

### Germany



#### FORTEC Elektronik AG

Augsburger Str. 2b  
82110 Germering

Phone: +49 89 894450-0  
E-Mail: [info@fortecag.de](mailto:info@fortecag.de)  
Internet: [www.fortecag.de](http://www.fortecag.de)

## Fortec Group Members

### Austria



#### Distec GmbH Office Vienna

Nuschinggasse 12  
1230 Wien

Phone: +43 1 8673492-0  
E-Mail: [info@distec.de](mailto:info@distec.de)  
Internet: [www.distec.de](http://www.distec.de)

### Germany



#### Distec GmbH

Augsburger Str. 2b  
82110 Germering

Phone: +49 89 894363-0  
E-Mail: [info@distec.de](mailto:info@distec.de)  
Internet: [www.distec.de](http://www.distec.de)

### Switzerland



#### ALTRAC AG

Bahnhofstraße 3  
5436 Würenlos

Phone: +41 44 7446111  
E-Mail: [info@altrac.ch](mailto:info@altrac.ch)  
Internet: [www.altrac.ch](http://www.altrac.ch)

### United Kingdom



#### Display Technology Ltd.

Osprey House, 1 Osprey Court  
Hichingbrooke Business Park  
Huntingdon, Cambridgeshire, PE29 6FN

Phone: +44 1480 411600  
E-Mail: [info@displaytechnology.co.uk](mailto:info@displaytechnology.co.uk)  
Internet: [www.displaytechnology.co.uk](http://www.displaytechnology.co.uk)

### USA



#### Apollo Display Technologies, Corp.

87 Raynor Avenue,  
Unit 1 Ronkonkoma,  
NY 11779

Phone: +1 631 5804360  
E-Mail: [info@apolloDisplays.com](mailto:info@apolloDisplays.com)  
Internet: [www.apolloDisplays.com](http://www.apolloDisplays.com)