



OUR GLOBAL
COMPETENCE
CENTRES

 APOLLO DISPLAY
TECHNOLOGIES



 DISTEC



 DISPLAY
TECHNOLOGY



Datasheet

SGD

GKIGA1VDMC1E0

SG-01-025



Product Specification				
	Model: GKIGA1VDMC1E0	Rev. No.	Issued Date.	Page.
		B	2022.12.05	1 / 16

Thin-Film-Transistor LCD Module
Model: GKIGA1VDMC1E0

Acceptance

Solomon Goldentek Display Corp.
NO. 18 Ta-Yeh St., Ta-Fa Industrial Park, Ta-Liao
Hsiang, Kaohsiung Hsien 831, TAIWAN , R.O.C.
FAX: 886-7-7886800

Approved and Checked by

Approved by	Checked by		Made by
			

Product Specification			
	Model: GKIGA1VDMC1E0	Rev. No.	Issued Date.
		B	2022.12.05
			Page.
			3 / 16

Contents

1.	General Description and Features	4
1.1	Features	4
1.2	LCD Module	4
2.	Mechanical Information	4
3.	Electrical Specifications	5
3.1	Absolute Max. Ratings	5
3.2	AC Timing Characteristic of The LCD	6
3.3	Timing Sequence(Timing Chart)	7
4.	Optical Characteristics	8
4.1	Optical characteristic of the LCD	8
5.	I/O Terminal	11
5.1	Pin Assignment	11
5.2	Back Light Unit	12
5.3	Block Diagram	13
6.	Displayed Color and Input Data	14
7.	Reliability Condition	15
8.	Dimensional Outlines	16

Product Specification

	Model: GKIGA1VDMC1E0	Rev. No.	Issued Date.	Page.
		B	2022.12.05	4 / 16

1. General Description and Features

GKIGA1VDMC1E0 is a transmissive type color active matrix TFT (Thin Film Transistor) liquid crystal display (LCD) that uses amorphous silicon TFT as a switching device. This model is composed of a TFT-LCD module, a receiver circuit and a back-light unit. Graphics and texts can be displayed on a WXGA 1280(W) x RGB x 800 (H) dots (16:10 aspect ratio) with 16.7M colors. The following table described the features of GKIGA1VDMC1E0.

1.1 Features

- Transmissive and back-light with 42 LEDs are available.
- IPS mode.
- LVDS Receiver 6/8 Bits Interface.
- RoHS Compliance

1.2 LCD Module

Item	Specification	Unit
Screen Size	10.1 inches	Diagonal
Display Resolution	1280 (H) x 800 (V)	Pixel
Active Area	216.96(H) x 135.6(V)	mm
Outline Dimension	229.8(H) x 149.0 (V) x 6.0 (T)	mm
Display Mode	Normally Black, IPS	--
Pixel Arrangement	R,G,B Stripe	--
Pixel Size	0.1695 x 0.1695	mm
Surface Treatment	Gloss(3H)	
Display Color	16.7M	--
Viewing Direction	Full View	--
Input Interface	LVDS Receiver 6/8 Bits Interface	--

2. Mechanical Information

Item	Min.	Typ.	Max.	Unit	Note	
Module Size	Horizontal (H)	(229.5)	(229.8)	(230.1)	mm	
	Vertical (V)	(148.7)	(149.00)	(149.3)	mm	
	Thickness (T)	(5.8)	(6.0)	(6.2)	mm	(1)
Weight	--	(187)	--	g	--	

Note (1) Not Include Component. Refer to the Outline Dimension Drawing as attached.

Product Specification

	Model: GKIGA1VDMC1E0	Rev. No.	Issued Date.	Page.
		B	2022.12.05	5 / 16

3. Electrical Specifications

3.1 Absolute Max. Ratings

3.1.1 Absolute Ratings of Environment

If the operating condition exceeds the following absolute maximum ratings, the TFT LCD module may be damaged permanently.

(Ta=25±2°C, V_{SS}=GND=0)

Item	Symbol	Min.	Max.	Unit	Note
Storage temperature	T _{STG}	-30	80	°C	(1)
Operating temperature	T _{OPR}	-30	80	°C	(1,2,3)

Note (1) 95 % RH Max. (40 °C ≥ Ta). Maximum wet-bulb temperature at 39 °C or less. (Ta > 40 °C) No condensation.

Note (2) In case of below 0°, the response time of liquid crystal (LC) becomes slower and the color of panel becomes darker than normal one. Level of retardation depends on temperature, because of LC's character

Note (3) Only operation is guaranteed at operating temperature. Contrast, response time, another display quality are evaluated at +25°C.

3.1.2 Electrical Absolute Maximum Ratings

3.1.2.1 TFT-LCD Module

(V_{SS}=GND=0)

Parameter	Symbol	Min.	Max.	Unit	Remark
Power Supply for LCM	V _{CC}	-0.3	7.0	V	

0.5<t₁≤10ms 200ms≤t₅
 0<t₂≤50ms 200ms≤t₆
 0<t₃≤50ms 200ms≤t₇
 0<t₄≤10ms

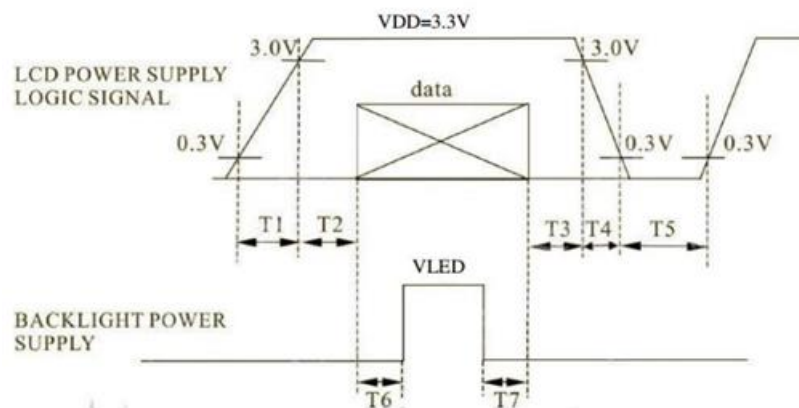

Product Specification

	Model: GKIGA1VDMC1E0	Rev. No.	Issued Date.	Page.
		B	2022.12.05	6 / 16

3.1.3 DC Electrical Characteristics of the TFT LCD

(Ta=25±2°C, V_{SS}=GND=0)

Item	Symbol	Min.	Typ.	Max.	Unit	Remark
Power supply for LCM	V _{CC}	3.0	3.3	3.6	V	
Power supply voltage for led driver	V _{LED}	-	12	-		
Power Supply current for led driver	I _{LED}	(570)	(650)			
Power Supply current for LCM	I _{DD}	--	(270)	--	mA	Note 1

Note1: fv =60Hz , Ta=25°C , Display pattern : Black pattern



3.1.4 Back-Light Specification

Item	Symbol	Min.	Typ.	Max.	Unit	Remark
EN Signal Voltage	High	1.5	-	5.0	V	
	Low	0	-	0.4		
PWM Frequency	PWM/EN	200		1000	Hz	Note 1
APWM Frequency	APWM	20		100	KHz	

Note1:PWM/EN=5V

3.2 AC Timing Characteristic of The LCD

3.2.1 Timing Condition

Parameter	Symbol	Min.	Typ.	Max.	Unit.
Frame Rate	--	--	60	--	Hz
Frame Period	T _v	815	823	1023	line
Vertical Display Time	T _{VD}	800			line
Vertical Blanking Time	T _{VW} +T _{VBP} +T _{VFP}	15	23	33	Line
1 Line Scanning Time	T _H	1410	1440	1470	Clock
Horizontal Display Time	T _{HD}	1280			Clock
Horizontal Blanking Time	T _{HW} +T _{HBP} +T _{HFP}	60	160	190	Clock
Clock Rate	1/TC	68.9	71.1	73.4	MHz

Product Specification



Model: GKIGA1VDMC1E0

Rev. No.

Issued Date.

Page.

B

2022.12.05

7 / 16

3.3 Timing Sequence(Timing Chart)

3.3.1 Horizontal Timing Sequence

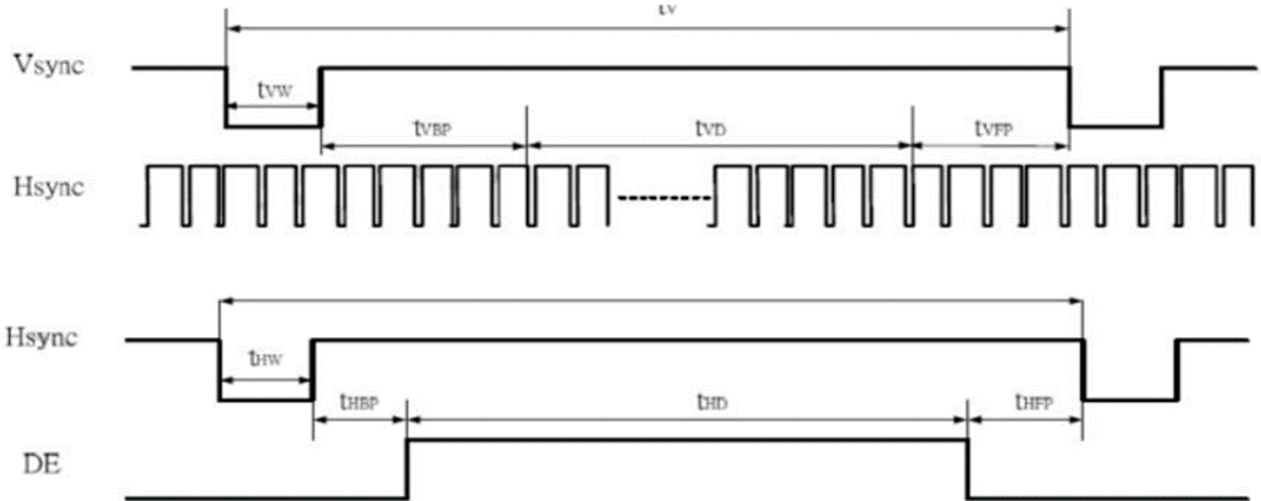

3.3.2 LVDS Input Data Mapping(VESA)

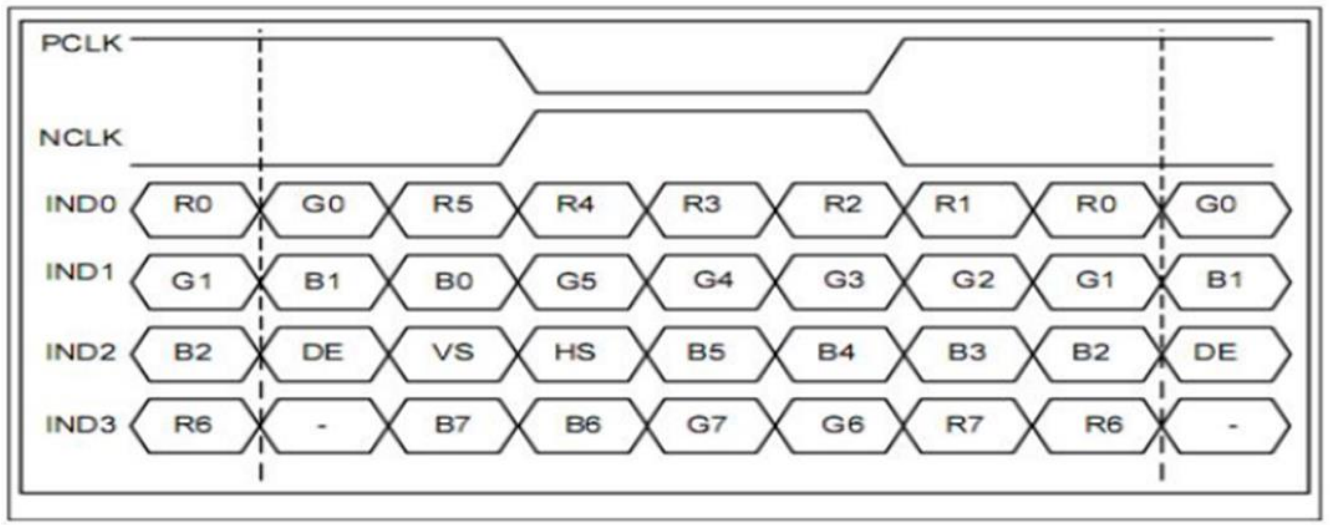

Product Specification

	Model: GKIGA1VDMC1E0	Rev. No.	Issued Date.	Page.
		B	2022.12.05	8 / 16

4. Optical Characteristics

4.1 Optical characteristic of the LCD

The following items are measured under stable conditions. The optical characteristics should be measured in a dark room or equivalent state with the methods.

Measuring equipment: BM-7A

Item	Symbol	Condition	Min	Type	Max	Unit	Note	
Brightness	B		800	1000	-	cd/m ²		
Response time	T _r +T _f	$\theta=0^\circ$	-	25	50	ms	.	
Contrast ratio(Center)	CR	At optimized viewing angle	(800)	(1000)	-	-		
Luminance Uniformity (9 Points)	ΔL		70	-	-	%		
Color Chromaticity (CIE 1931)	White	W _x	$\theta=0^\circ$ Normal Viewing Angle	0.265	0.315	0.365	--	BM-7A
		W _y		0.292	0.342	0.392		
Viewing Angle	Hor.	θ_R	CR \geq 10	(70)	(80)	--	Degree	
		θ_L		(70)	(80)	--		
	Ver.	θ_U		(70)	(80)	--		
		θ_D		(70)	(80)	--		
LED Life Time	-	-	50000	-	-	hr		

a. Test equipment setup

After stabilizing and leaving the panel alone shall be warmed up for the stable operation of LCM, the measurement should be executed. Measurement should be executed in a stable, windless, and dark room. Optical specifications are measured by Topcon BM-7(fast) with a viewing angle of 2° at a distance of 50cm and normal direction.

b. Definition of response time: Tr and Tf

The response time is defined as the following figure and shall be measured by switching the input signal for "black" and "white".

Product Specification



Model: GKIGA1VDMC1E0

Rev. No.

Issued Date.

Page.

B

2022.12.05

9 / 16

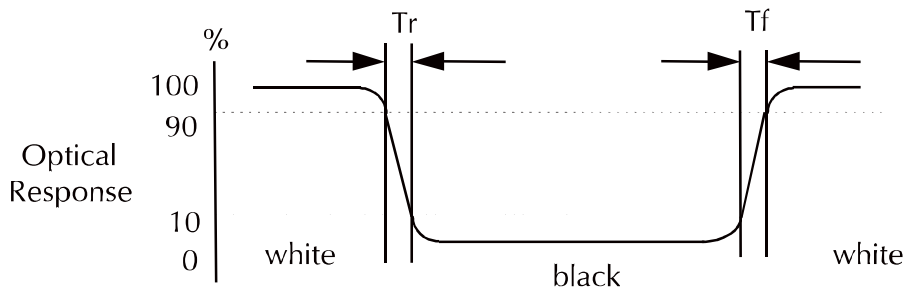

c. Definition of contrast ratio:

Brightness measured when LCD is at "white state"

$$\text{Contrast Ratio (CR)} = \frac{\text{Brightness measured when LCD is at "white state"}}{\text{Brightness measured when LCD is at "black state"}}$$

Brightness measured when LCD is at "black state"

d. Measured at the center area of the panel when all the input terminals of LCD panel are electrically opened.

e. View Angle

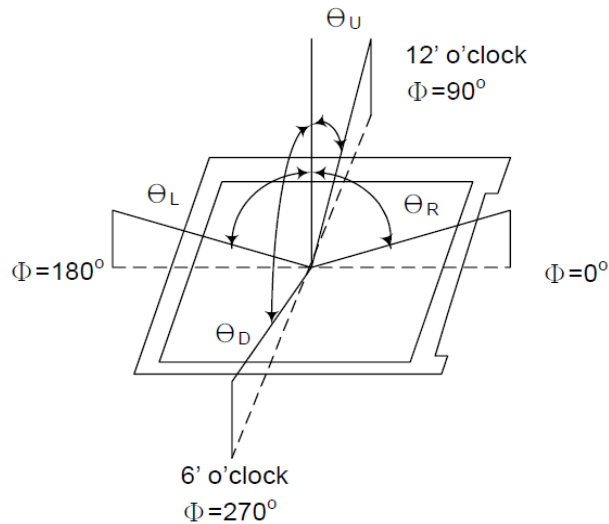

f. Definition of Luminance of White: Luminance of white at the center points

Light Source of Back-Light Unit	LED Type
---------------------------------	----------

Product Specification

	Model: GKIGA1VDMC1E0	Rev. No.	Issued Date.	Page.
		B	2022.12.05	10 / 16

g. Definition of White Uniformity

$$\text{White Uniformity} = \frac{\text{Min. luminance of white among 9-points}}{\text{Max. luminance of white among 9-points}} \times 100\%$$

h. The definition of Color Gamut -Color Chromaticity CIE 1931

Color coordinate of white & red, green, blue at center point.

Color Gamut : NTSC(%) = (RGB Triangle Area / NTSC Triangle Area) x 100

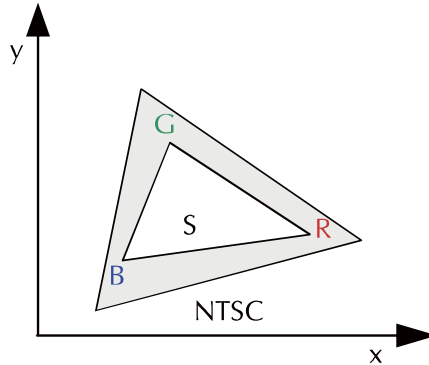

Product Specification



Model: GKIGA1VDMC1E0

Rev. No.

Issued Date.

Page.

B

2022.12.05

11 / 16

5. I/O Terminal

5.1 Pin Assignment (Part No: JAE F1-SE20P-HFE-E3000) or equivalent

Pin No.	Symbol	I/O	Function	Remark
1	LND3+	I	+LVDS differential data input	
2	LND3-	I	-LVDS differential data input	
3	NC	--	Not connect	
4	SEL6/8	I/O	H:8bit L:6bit	
5	VSS	I	Ground	
6	PINC	I	+LVDS differential clock input	
7	NINC	I	-LVDS differential clock input	
8	VSS	P	Ground	
9	IND2+	I	+LVDS differential data input	
10	IND2-	I	-LVDS differential data input	
11	VSS	P	Ground	
12	IND1+	I	+LVDS differential data input	
13	IND1-	I	-LVDS differential data input	
14	VSS	P	Ground	
15	IND0+	I	+LVDS differential data input	
16	IND0-	I	-LVDS differential data input	
17	VSS-	P	Ground	
18	NC	--	Not connect	
19-20	VDD	P	Power	

Notes:

- 1) NC Pin must be retained; this pin can't contact GND or other signal.
- 2) GND Pin must ground contact, can not be floating.

Product Specification

	Model: GKIGA1VDMC1E0	Rev. No.	Issued Date.	Page.
		B	2022.12.05	12 / 16

5.2 Back Light Unit.

Pin Assignment (Part No: JAE F1-S6P-HFE-E1500) or equivalent

Pin No.	Symbol	I/O	Function	Remark
1-2	VLED	P	Power Supply(+12.0V)	
3-4	VLSS	P	Ground	
5	LED EN	I	LED enable pin	
6	LED PWM	I	Power input signal for LED driver	

Pin Assignment (Part No: MOLEX 53261-0871) or equivalent

Pin No.	Symbol	I/O	Function	Remark
1	VDD	P	Power Supply(3.3V)	
2	D-	I	D- data input	
3	D+	I	D+ data input	
4	VSS	P	Ground	
5-8	NC		Not connect	

Product Specification

	Model: GKIGA1VDMC1E0	Rev. No.	Issued Date.	Page.
		B	2022.12.05	13 / 16

5.3 Block Diagram

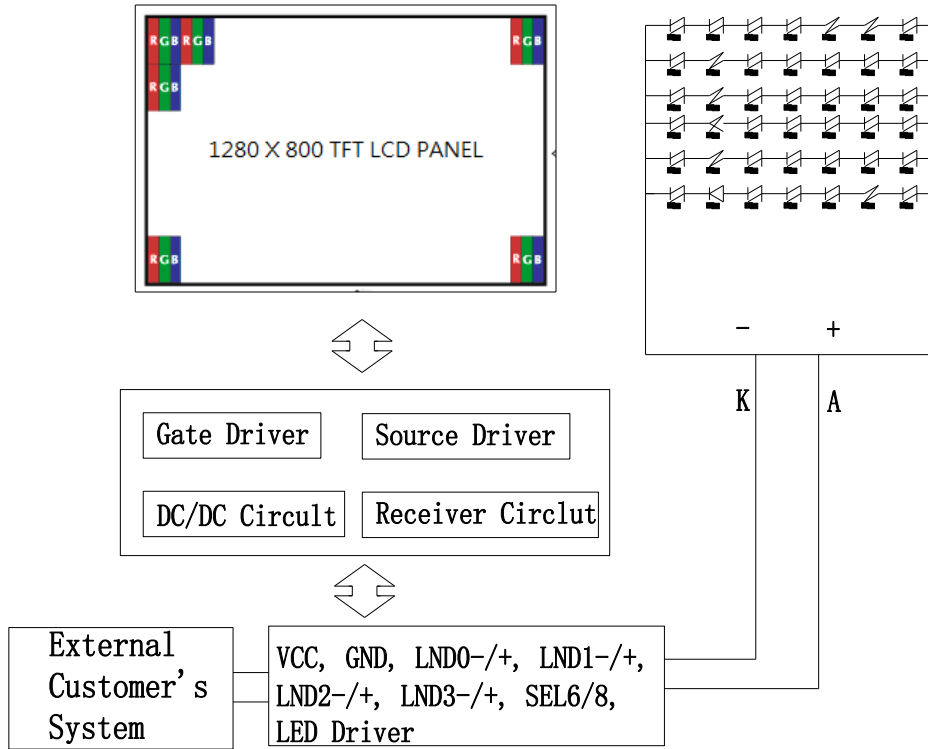

Product Specification

	Model: GKIGA1VDMC1E0	Rev. No.	Issued Date.	Page.
		B	2022.12.05	14 / 16

6. Displayed Color and Input Data

COLOR	INPUT DATA	R DATA								G DATA								B DATA							
		R7	R6	R5	R4	R3	R2	R1	R0	G7	G6	G5	G4	G3	G2	G1	G0	B7	B6	B5	B4	B3	B2	B1	B0
		MSB							LSB	MSB							LSB	MSB							LSB
BASIC COLOR	BLACK	0	0	0	0	0	0	0	0	0	0	0	0	0	0	0	0	0	0	0	0	0	0	0	0
	RED(255)	1	1	1	1	1	1	1	1	0	0	0	0	0	0	0	0	0	0	0	0	0	0	0	0
	GREEN(255)	0	0	0	0	0	0	0	0	1	1	1	1	1	1	1	1	0	0	0	0	0	0	0	0
	BLUE(255)	0	0	0	0	0	0	0	0	0	0	0	0	0	0	0	0	1	1	1	1	1	1	1	1
	CYAN	0	0	0	0	0	0	0	0	1	1	1	1	1	1	1	1	1	1	1	1	1	1	1	1
	MAGENTA	1	1	1	1	1	1	1	1	0	0	0	0	0	0	0	0	1	1	1	1	1	1	1	1
	YELLOW	1	1	1	1	1	1	1	1	1	1	1	1	1	1	1	1	0	0	0	0	0	0	0	0
	WHITE	1	1	1	1	1	1	1	1	1	1	1	1	1	1	1	1	1	1	1	1	1	1	1	1
RED	RED(0)	0	0	0	0	0	0	0	0	0	0	0	0	0	0	0	0	0	0	0	0	0	0	0	
	RED(1)	0	0	0	0	0	0	0	1	0	0	0	0	0	0	0	0	0	0	0	0	0	0	0	
	RED(2)	0	0	0	0	0	0	1	0	0	0	0	0	0	0	0	0	0	0	0	0	0	0	0	
	RED(254)	1	1	1	1	1	1	1	0	0	0	0	0	0	0	0	0	0	0	0	0	0	0	0	0
	RED(255)	1	1	1	1	1	1	1	1	0	0	0	0	0	0	0	0	0	0	0	0	0	0	0	0
GREEN	GREEN(0)	0	0	0	0	0	0	0	0	0	0	0	0	0	0	0	0	0	0	0	0	0	0	0	
	GREEN(1)	0	0	0	0	0	0	0	0	0	0	0	0	0	0	1	0	0	0	0	0	0	0	0	
	GREEN(2)	0	0	0	0	0	0	0	0	0	0	0	0	0	1	0	0	0	0	0	0	0	0	0	
	GREEN(254)	0	0	0	0	0	0	0	0	1	1	1	1	1	1	0	0	0	0	0	0	0	0	0	0
GREEN(255)	0	0	0	0	0	0	0	0	1	1	1	1	1	1	1	0	0	0	0	0	0	0	0	0	
BLUE	BLUE(0)	0	0	0	0	0	0	0	0	0	0	0	0	0	0	0	0	0	0	0	0	0	0	0	
	BLUE(1)	0	0	0	0	0	0	0	0	0	0	0	0	0	0	0	0	0	0	0	0	0	0	1	
	BLUE(2)	0	0	0	0	0	0	0	0	0	0	0	0	0	0	0	0	0	0	0	0	0	1	0	
	BLUE(254)	0	0	0	0	0	0	0	0	0	0	0	0	0	0	0	1	1	1	1	1	1	1	0	0
BLUE(255)	0	0	0	0	0	0	0	0	0	0	0	0	0	0	0	1	1	1	1	1	1	1	1	1	

0 : Low level voltage, 1 :High level voltage

Each basic color can be displayed in 256 gray scales from 8 bit data signals. With the combination of total 24 bit data signals, the 16,777,216-color display can be achieved on the screen.

Product Specification

	Model: GKIGA1VDMC1E0	Rev. No.	Issued Date.	Page.
		B	2022.12.05	15 / 16

7. Reliability Condition

No change on display and in operation under the following test condition.

Condition: Unless otherwise specified, tests will be conducted under the following condition.

Temperature: $20 \pm 5^\circ\text{C}$.

Humidity: $65 \pm 5\% \text{RH}$.

Tests will be not conducted under functioning state.

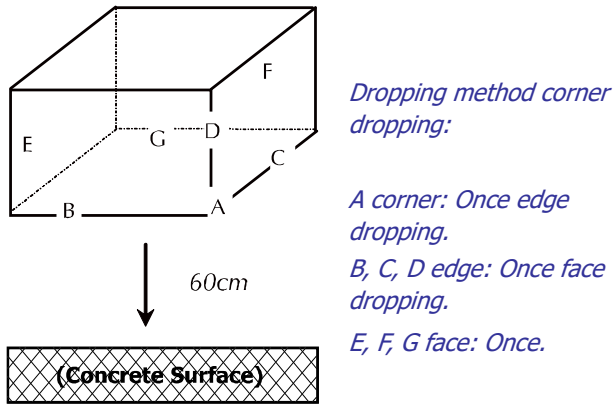
No.	Parameter	Condition	Notes
1	High Temperature Operating	$80^\circ\text{C} \pm 2^\circ\text{C}$, 240hrs (Operation state).	
2	Low Temperature Operating	$-30^\circ\text{C} \pm 2^\circ\text{C}$, 240hrs (Operation state).	1
3	High Temperature Storage	$80^\circ\text{C} \pm 2^\circ\text{C}$, 240hrs.	2
4	Low Temperature Storage	$-30^\circ\text{C} \pm 2^\circ\text{C}$, 240hrs.	1,2
5	High Temperature and High Humidity Storage Test	$60^\circ\text{C} \pm 2^\circ\text{C}$, 90%, 240hrs.	1,2
6	Vibration Test	Total fixed amplitude: 1.5mm. Vibration Frequency: 10~55Hz. One cycle 60 seconds to 3 direction of X, Y, Z each 15 minutes.	3
7.	Drop Test	To be measured after dropping from 60cm high on the concrete surface in packing state.  <p style="margin-left: 20px;"><i>Dropping method corner dropping:</i></p> <p style="margin-left: 20px;"><i>A corner: Once edge dropping.</i></p> <p style="margin-left: 20px;"><i>B, C, D edge: Once face dropping.</i></p> <p style="margin-left: 20px;"><i>E, F, G face: Once.</i></p>	

- Notes:
1. No dew condensation to be observed.
 2. The function test shall be conducted after 4 hours storage at the normal temperature and humidity after removed from the test chamber.
 3. Vibration test will be conducted to the product itself without putting I in a container.

Product Specification



Model: GKIGA1VDMC1E0

Rev. No.

Issued Date.

Page.

B

2022.12.05

16 / 16

8. Dimensional Outlines

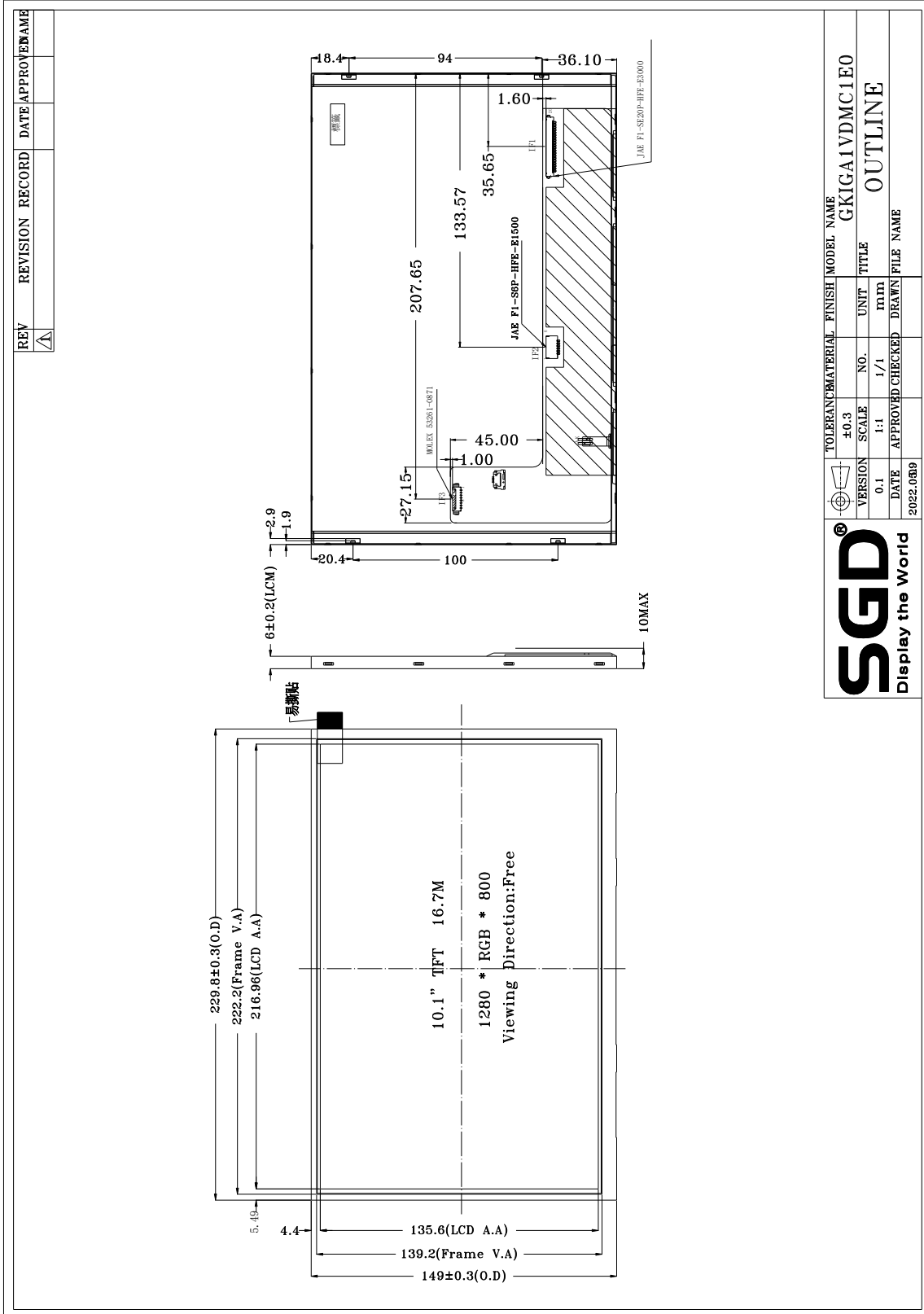

Our company network supports you worldwide with offices in Germany, Austria, Switzerland, the UK and the USA. For more information please contact:

Headquarters

Germany



FORTEC Elektronik AG

Augsburger Str. 2b
82110 Germering

Phone: +49 89 894450-0
E-Mail: info@forteca.de
Internet: www.forteca.de

Fortec Group Members

Austria



Distec GmbH Office Vienna

Nuschinggasse 12
1230 Wien

Phone: +43 1 8673492-0
E-Mail: info@distec.de
Internet: www.distec.de

Germany



Distec GmbH

Augsburger Str. 2b
82110 Germering

Phone: +49 89 894363-0
E-Mail: info@distec.de
Internet: www.distec.de

Switzerland



ALTRAC AG

Bahnhofstraße 3
5436 Würenlos

Phone: +41 44 7446111
E-Mail: info@altrac.ch
Internet: www.altrac.ch

United Kingdom



Display Technology Ltd.

Osprey House, 1 Osprey Court
Hichingbrooke Business Park
Huntingdon, Cambridgeshire, PE29 6FN

Phone: +44 1480 411600
E-Mail: info@displaytechnology.co.uk
Internet: www.displaytechnology.co.uk

USA



Apollo Display Technologies, Corp.

87 Raynor Avenue,
Unit 1 Ronkonkoma,
NY 11779

Phone: +1 631 5804360
E-Mail: info@apolloDisplays.com
Internet: www.apolloDisplays.com