



OUR GLOBAL
COMPETENCE
CENTRES

 APOLLO DISPLAY
TECHNOLOGIES



 DISTEC



 DISPLAY
TECHNOLOGY



Datasheet

BOE

DV750QUM-R11

BO-01-021



PROPRIETARY NOTE

THIS SPECIFICATION IS THE PROPERTY OF BOEHF AND SHALL NOT BE REPRODUCED OR COPIED WITHOUT THE WRITTEN PERMISSION OF BOEHF AND MUST BE RETURNED TO BOEHF UPON ITS REQUEST

DV750QUM-R11

Product Specification

Rev. P1

HEFEI BOE Display TECHNOLOGY CO., LTD

SPEC. NUMBER

S8-65-AA-213

PRODUCT GROUP

TFT-LCD

Rev. P1

ISSUE DATE

2024/02/06

PAGE

1 OF 38

REVISION HISTORY Preliminary specification Final specification

Revision No.	Page	Description of changes	Date	Prepared
P0	40	Initial Release	2023/11/20	Yi Hong Liang
P1	4	Update Backlight Local Diming	2024/02/06	Geng shixin

Contents

No	ITEM	Page
	REVISIONS HISTORY	2
	CONTENTS	3
1	GENERAL DESCRIPTION	4
	1.1 Introduction	
	1.2 Features	
	1.3 Application	
	1.4 General Specification	
2	ABSOLUTE MAXIMUM RATINGS	6
3	ELECTRICAL SPECIFICATIONS	7
	3.1 TFT LCD Module	
	3.2 Backlight Unit	
	3.3 Backlight Input Pin Assignments	
4	INTERFACE CONNECTION	11
	4.1 Module Input Signal & Power	
	4.2 CNT Dimension	
	4.3 V by One Misc. Setting.-1 Section	
5	SIGNAL TIMING WAVEFORMS OF INTERFACE SIGNAL	17
	5.1 Input Data Specification CN1	
	5.2 Signal Timing Waveform	
6	SIGNAL TIMING SPECIFICATION	19
	6.1 Timing Parameters	
	6.2 Input Signals, Basic Display Colors and Gray Scale of Colors	
	6.3 Power Sequence	
7	OPTICAL SPECIFICATIONS	23
8	MECHANICAL CHARACTERISTICS	25
9	RELIABILITY TEST	26
10	PRODCUT SERIAL NUMBER	27
11	PACKING INFORMATION	28
12	PRECAUTIONS	30
13	APPENDIX	35

1.0 GENERAL DESCRIPTION

1.1 Introduction

DV750QUM-R11 is a color active matrix TFT LCD Module using amorphous silicon TFT's (Thin Film Transistors) as an active switching devices. This module has a 75 inch diagonally measured active area with UHD resolutions (3840 horizontal by 2160 vertical pixel array). Each pixel is divided into RED, GREEN, BLUE dots which are arranged in vertical stripe and this module can display 1.07G colors. The TFT-LCD panel used for this module is adapted for a low reflection and higher color type.

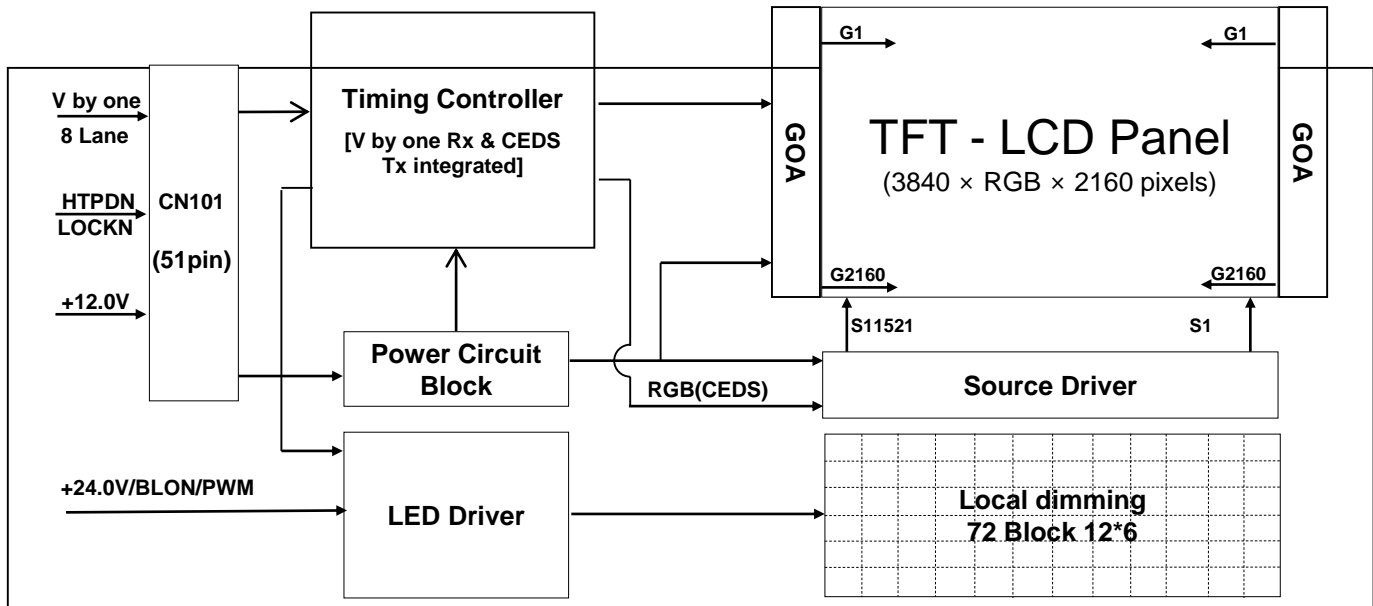

1.2 Features

- V by one interface with 8 lanes
- High-speed response
- Low color shift image quality
- 8-bit + FRC color depth, display 1.07G colors
- Wide viewing angle
- ADS technology is applied for high display quality
- RoHS compliant
- Landscape and Portrait usage support
- Polarizer: Wide temperature QWP(80°C)
- 2500/3500nit MDL brightness usage support
- Liquid crystal: High Tni LC(104.6°C)

1.3 Application

- Outdoor Commercial Digital Display
- Outdoor Display Terminals for Control System
- Outdoor Landscape and Portrait Signage Display

1.4 General Specification

< Table 1. General Specifications >

Parameter	Specification	Unit	Remarks
Active area	1649.664(H) × 927.936(V)	mm	
Number of pixels	3840(H) × 2160 (V)	pixels	
Pixel pitch	429.6(H) × 429.6(V)	um	
Pixel arrangement	Pixels RGB Vertical stripe		
Display colors	1.07G	colors	8-bit + FRC
Display mode	Normally Black		
Dimensional outline	1675.7(H)*956.1(V)*66.8(D)	mm	Detail refer to drawing
Bezel width (L/R/U/D)	10.9/10.9/10.9/13.1	mm	
Weight	30±1	kg	
Power Consumption (3500nit)	12W (Logic) +672(BLU)	Watt	Typ.
Power Consumption (2500nit)	12W (Logic) +504(BLU)		
Surface Treatment	AGLR (Front Polarizer) Clear (Bottom Polarizer)		
Back-light	D-LED		

2.0 ABSOLUTE MAXIMUM RATINGS

The followings are maximum values which, if exceed, may cause faulty operation or damage to the unit. The operational and non-operational maximum voltage and current values are listed in Table 2.

< Table 2. Module Electrical Specifications >

[VSS=GND=0V]

Parameter	Symbol	Min.	Max.	Unit	Remark
Power Supply Voltage	VDD	VSS-0.3	13.5	V	Ta = 25 °C
	VBLU	VSS-0.3	26.7	V	Ta = 25 °C
Operating Temperature	T _{OP}	-20	+60	°C	Note 1/2
Storage Temperature	T _{ST}	-30	+80	°C	
Operating Ambient Humidity	Hop	20	90	%RH	
Storage Humidity	Hst	5	90	%RH	

Note1: Operating Temperature is OC with high brightness BLU, MDL brightness=3500nit

Noite2: Temperature and relative humidity range are shown in the figure below.

Wet bulb temperature should be 39 °C max. and no condensation of water.

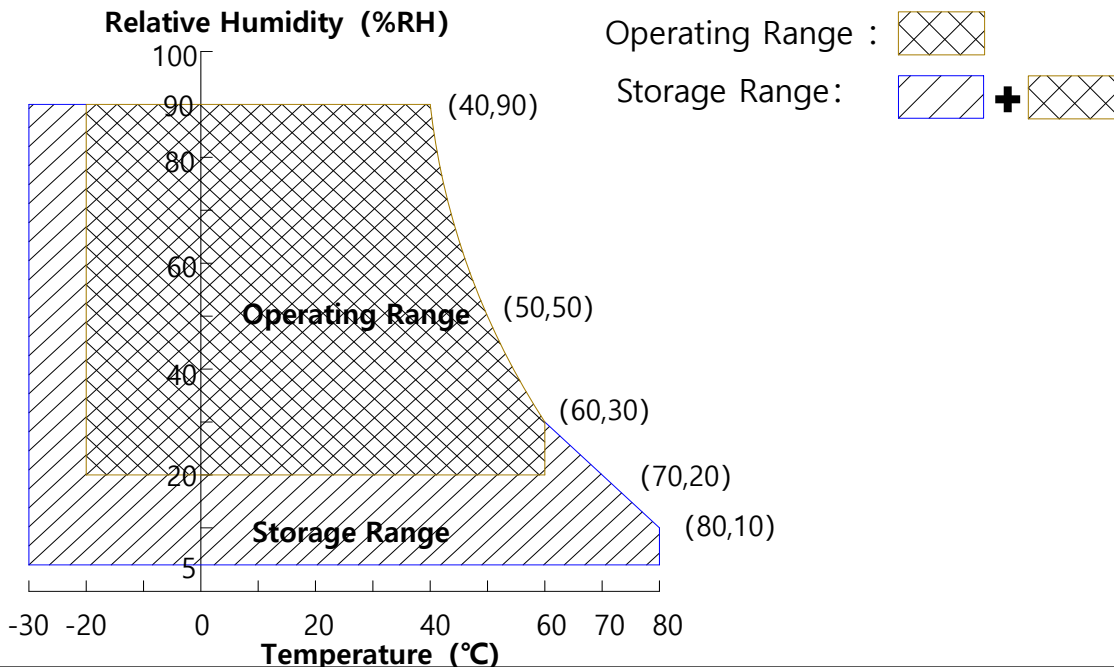

3.0 ELECTRICAL SPECIFICATIONS

3.1 TFT LCD Module

< Table 3 Module Electrical Specifications >

[Ta =25±2 °C]

Parameter		Symbol	Values			Unit	Remark
			Min	Typ	Max		
Power Supply Input Voltage		VDD	10.8	12	13.2	Vdc	
Power Supply Ripple Voltage		VRP	-	-	600	mV	
Power Supply Current		IDD	-	1000	2500	mA	Note 1
Power Consumption		PDD	-	12	30	Watt	
Rush current		IRUSH	-	-	10	A	Note 2
V by One Interface	Differential Input High Threshold Voltage	VLVTH	-	-	+50	mV	Note 3
	Differential Input Low Threshold Voltage	VLVTL	-50	-	-	mV	
	Common Input Voltage	VLVC	-	0	-	V	
CMOS Interface	Input High Threshold Voltage	VIH	2.7	-	3.3		
	Input Low Threshold Voltage	VIL	0	-	0.6	V	

Note 1 : The supply voltage is measured and specified at the interface connector of LCM.

The current draw and power consumption specified is for VDD=12.0V,

Frame rate fV=60Hz and Clock frequency = 74.25MHz.

Test Pattern of power supply current

Note 2 : The duration of rush current is about 2ms and rising time of Power Input is 0.5ms(min)

a) Typ : Mosaic 7X5 (L0/L255)

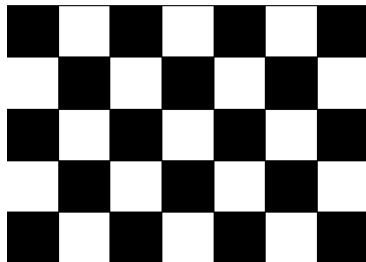

b) Max : Horizontal 1 Line (L0/L255)



c) Flicker Test Pattern

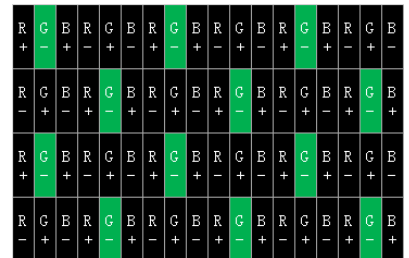

Note 3 : V By one signal Eye diagram should be OK. Otherwise, there will be abnormal display.

3.0 ELECTRICAL SPECIFICATIONS

3.2 Backlight Unit < Table 4. Backlight Unit Electrical Specifications >

[Ta =25±2 °C]

Parameter		Min.	Typ.	Max.	Unit	Remarks
Power Supply Input Voltage	VDD	21.6	24	26.4	Vdc	
Power Supply Ripple Voltage	VRP	-	-	4500	mV	
Power Supply Current	IDD	-	28	30	A	
Rush current	IRUSH	-	-	35	A	Note 1
Power Consumption	PDD	-	672	720	Watt	PWM Duty =100%
		-	504	520		PWM Duty =72%
LED Life-Time	N/A	50000	-	-	Hour	IF = 100mA
PWM Control Level	PWM High Level	-	2.7	3.3	V	
	PWM Low Level	-	0	-	0.7	V
LEDEN Control Level	LEDEN High Level	-	2.7	3.3	V	
	LEDEN Low Level	-	0	-	0.7	V
PWM Control Frequency	F _{PWM}	120	-	300	Hz	
Duty Ratio	-	1	-	100	%	

Notes : 1. The duration of rush current is about 2ms and rising time of Power Input is 1ms(min)

3.3 Backlight Input Pin Assignments

Connector type_MASTER_CN11 : 20022WR-H14B2 pin or equivalent

Pin No.	Symbol	Feature
1	VIN	Operating Voltage Supply, +24V DC regulated
2	VIN	Operating Voltage Supply, +24V DC regulated
3	VIN	Operating Voltage Supply, +24V DC regulated
4	VIN	Operating Voltage Supply, +24V DC regulated
5	VIN	Operating Voltage Supply, +24V DC regulated
6	GND	Ground and Current Return
7	GND	Ground and Current Return
8	GND	Ground and Current Return
9	GND	Ground and Current Return
10	GND	Ground and Current Return
11	NC	NC
12	BL_ON	BLU On-Off control: DC 0 to 0.7V off, DC 2.7 to 5V On
13	NC	NC
14	PWM	$1\% \leq \text{Duty} \leq 100\%$

Connector type_MASTER_CN12 : 20022WR-H12 pin or equivalent

Pin No.	Symbol	Feature
1	VIN	Operating Voltage Supply, +24V DC regulated
2	VIN	Operating Voltage Supply, +24V DC regulated
3	VIN	Operating Voltage Supply, +24V DC regulated
4	VIN	Operating Voltage Supply, +24V DC regulated
5	VIN	Operating Voltage Supply, +24V DC regulated

Pin No.	Symbol	Feature
6	GND	Ground and Current Return
7	GND	Ground and Current Return
8	GND	Ground and Current Return
9	GND	Ground and Current Return
10	GND	Ground and Current Return
11	NC	NC
12	NC	NC

Connector type_SLAVE_CN11 : 20022WR-H14B2 pin or equivalent

Pin No.	Symbol	Feature
1	VIN	Operating Voltage Supply, +24V DC regulated
2	VIN	Operating Voltage Supply, +24V DC regulated
3	VIN	Operating Voltage Supply, +24V DC regulated
4	VIN	Operating Voltage Supply, +24V DC regulated
5	VIN	Operating Voltage Supply, +24V DC regulated
6	GND	Ground and Current Return
7	GND	Ground and Current Return
8	GND	Ground and Current Return
9	GND	Ground and Current Return
10	GND	Ground and Current Return
11	NC	NC
12	NC	NC
13	NC	NC
14	NC	NC

Connector type_SLAVE_CN12 : 20022WR-H12 pin or equivalent

Pin No.	Symbol	Feature
1	VIN	Operating Voltage Supply, +24V DC regulated
2	VIN	Operating Voltage Supply, +24V DC regulated
3	VIN	Operating Voltage Supply, +24V DC regulated
4	VIN	Operating Voltage Supply, +24V DC regulated
5	VIN	Operating Voltage Supply, +24V DC regulated
6	GND	Ground and Current Return
7	GND	Ground and Current Return
8	GND	Ground and Current Return
9	GND	Ground and Current Return
10	GND	Ground and Current Return
11	NC	NC
12	NC	NC

4.0 INTERFACE CONNECTION

4.1 Module Input Signal & Power: : Cable length suggest less than 500mm

- VBO Connector : IS050-C51B-C39-S(UJU).

< Table 5. Module Input Connector Pin Configuration >

Pin No	Symbol	Description	Pin No	Symbol	Description
1	VCC	Power supply (10.8~13.2V)	16	NC	No connection
2	VCC	Power supply (10.8~13.2V)	17	NC	No connection
3	VCC	Power supply (10.8~13.2V)	18	SDA	I2C Data for BOE Use Only
4	VCC	Power supply (10.8~13.2V)	19	SCL	I2C Clock fo BOE Use Only
5	VCC	Power supply (10.8~13.2V)	20	Local_ON	Local dimming on/off High (Default) or NC: LD On, typ 3.3V, 3.0~3.5V Low : LD off, 0~0.7V
6	VCC	Power supply (10.8~13.2V)	21	NC	No connection
7	VCC	Power supply (10.8~13.2V)	22	Section	VX1 SECTION
8	VCC	Power supply (10.8~13.2V)	23	NC	No connection
9	NC	No connection	24	GND	GROUND
10	GND	GROUND	25	HTPDN	Hot plug
11	GND	GROUND	26	LOCKN	LOCK
12	GND	GROUND	27	GND	GROUND
13	GND	GROUND	28	RX0N	Negative VBO differential data input0
14	GND	GROUND	29	RX0P	Positive VBO differential data input0
15	NC	No connection	30	GND	GROUND

Pin No	Symbol	Description	Pin No	Symbol	Description
31	RX1N	Negative VBO differential data input1	42	GND	GROUND
32	RX1P	Positive VBO differential data input1	43	RX5N	Negative VBO differential data input5
33	GND	GROUND	44	RX5P	Positive VBO differential data input5
34	RX2N	Negative VBO differential data input2	45	GND	GROUND
35	RX2P	Positive VBO differential data input2	46	RX6N	Negative VBO differential data input6
36	GND	GROUND	47	RX6P	Positive VBO differential data input6
37	RX3N	Negative VBO differential data input3	48	GND	GROUND
38	RX3P	Positive VBO differential data input3	49	RX7N	Negative VBO differential data input7
39	GND	GROUND	50	RX7P	Positive VBO differential data input7
40	RX4N	Negative VBO differential data input4	51	GND	GROUND
41	RX4P	Positive VBO differential data input4			

Notes : 1. NC (Not Connected) : This pins are only used for BOE internal operations.

Rear view of LCM

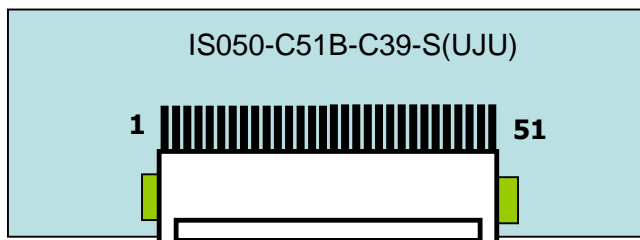

BIST Pattern



4.2 Dimension

4-2 CNT Dimension

TCON-51pin Connector: IS050-C51B-C39-S

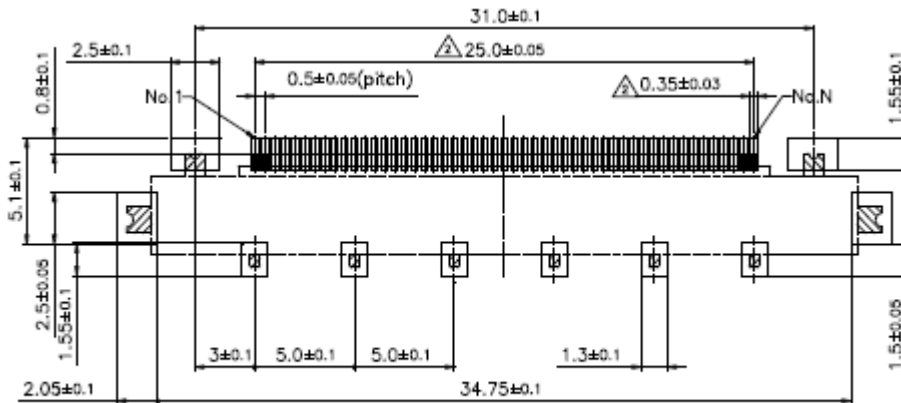
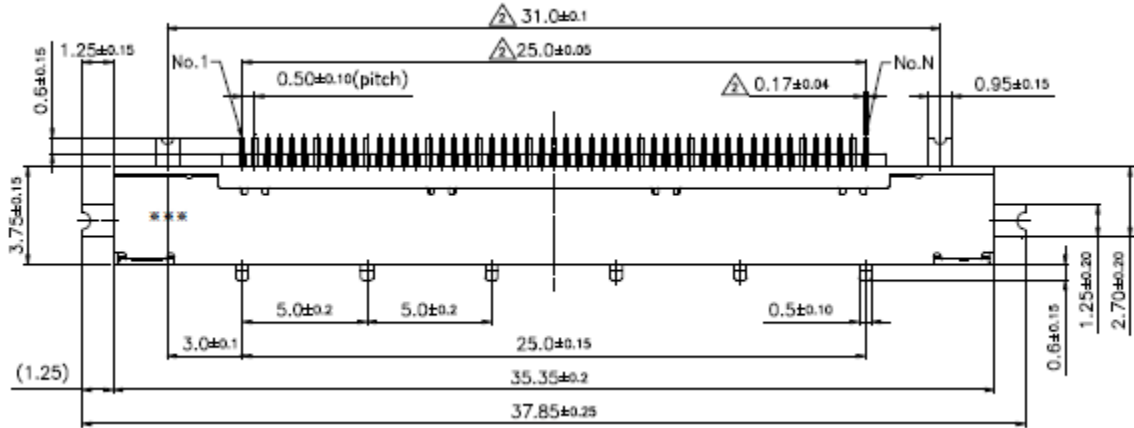

APPLICABLE P.C.B. DIMENSION
(Scale 4:1)

(25.0)

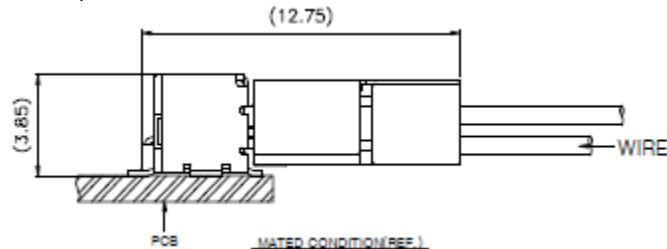
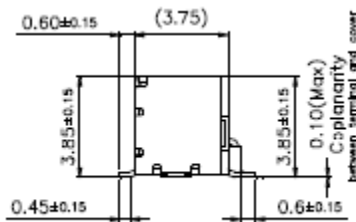
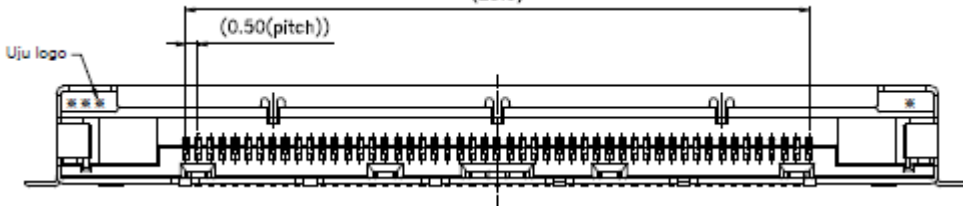

4.2 Dimension

4-2 CNT Dimension

Converter-14pin Connector : 20022WR-H14B2

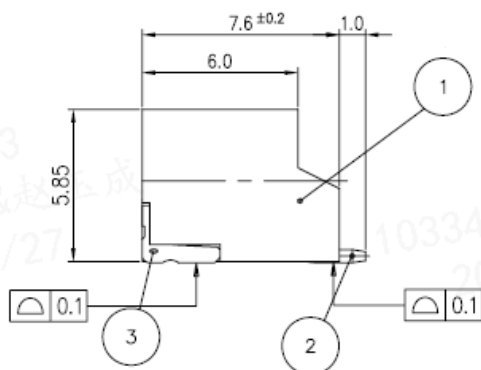
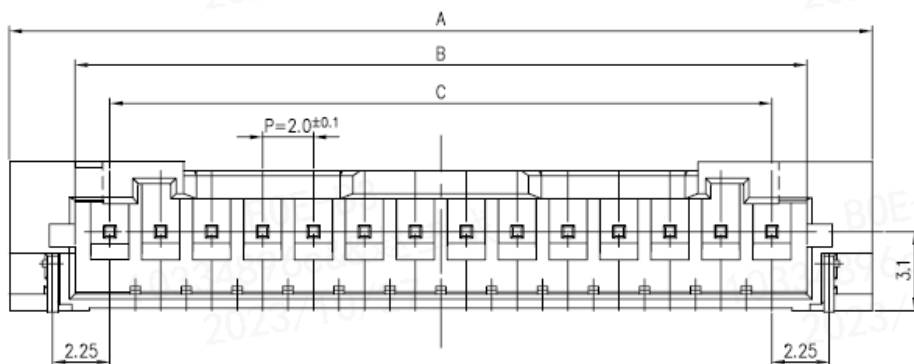
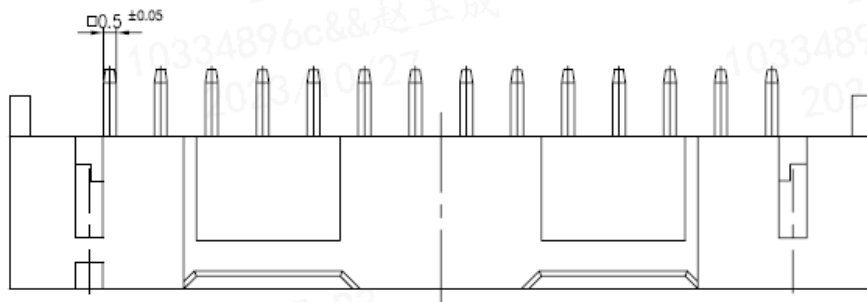

Circuits	Part NO	A	B	C
✓ 12	20022WR-H12B2	29.9	24.75	22.0
✓ 13	20022WR-H13B2	31.9	26.75	24.0
✓ 14	20022WR-H14B2	33.9	28.75	26.0
✓ 15	20022WR-H15B2	35.9	30.75	28.0
✓ 16	20022WR-H16B2	37.9	32.75	30.0

4.2 Dimension

4-2 CNT Dimension

Converter-12pin Connector : 20022WR-H12

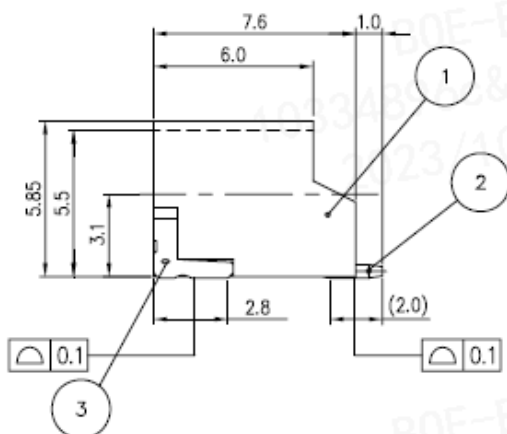
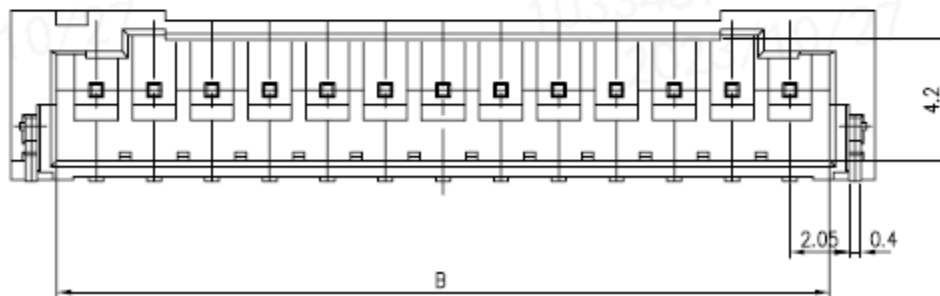
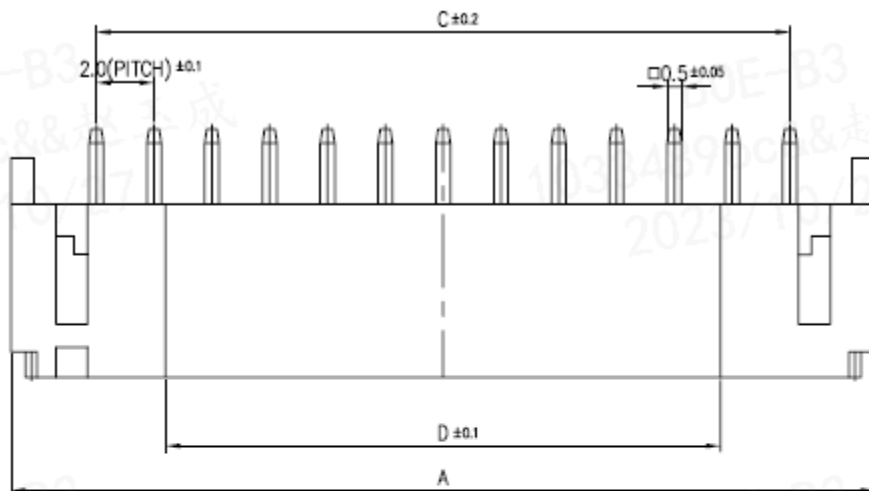

Circuits	Part NO	A	B	C	D
2	20022WR-H02A	8.00	4.75	2.0	
3	20022WR-H03A	10.0	6.75	4.0	
4	20022WR-H04A	12.0	8.75	6.0	
5	20022WR-H05A	14.0	10.75	8.0	
6	20022WR-H06A	16.0	12.75	10.0	5.2
7	20022WR-H07A	18.0	14.75	12.0	7.2
8	20022WR-H08A	20.0	16.75	14.0	9.2
9	20022WR-H09A	22.0	18.75	16.0	11.2
10	20022WR-H10A	24.0	20.75	18.0	13.2
11	20022WR-H11A	26.0	22.75	20.0	15.2
12	20022WR-H12A	28.0	24.75	22.0	17.2
13	20022WR-H13A	30.0	26.75	24.0	19.2
14	20022WR-H14A	32.0	28.75	26.0	21.2
15	20022WR-H15A	34.0	30.75	28.0	23.2

4.3 V by One Misc. Setting.-1 Section

- a) System side have to put pull high resistor on LOCKN/HTPDN pins.
- b) V by one data mapping as follows.

< Table 6. V by one setting & data mapping Table >

1Section								
Hactive=3840								
	port0		port1		port2		port3	
	Lane 0	Lane 1	Lane 2	Lane 3	Lane 4	Lane 5	Lane 6	Lane 7
V Blanking	PSBS	PSBS	PSBS	PSBS	PSBS	PSBS	PSBS	PSBS
	FSBP	FSBP	FSBP	FSBP	FSBP	FSBP	FSBP	FSBP

	FSBP	FSBP	FSBP	FSBP	FSBP	FSBP	FSBP	FSBP
	FSBE SR	FSBE SR	FSBE SR	FSBE SR	FSBE SR	FSBE SR	FSBE SR	FSBE SR
Line 1	Pixel 1	Pixel 2	Pixel 3	Pixel 4	Pixel 5	Pixel 6	Pixel 7	Pixel 8
	Pixel 9	Pixel 10	Pixel 11	Pixel 12	Pixel 13	Pixel 14	Pixel 15	Pixel 16

	Pixel3833	Pixel3834	Pixel3835	Pixel3836	Pixel3837	Pixel3838	Pixel3839	Pixel3840
H Blanking	PSBS	PSBS	PSBS	PSBS	PSBS	PSBS	PSBS	PSBS
	FSBP	FSBP	FSBP	FSBP	FSBP	FSBP	FSBP	FSBP

	FSBP	FSBP	FSBP	FSBP	FSBP	FSBP	FSBP	FSBP
	FSBE	FSBE	FSBE	FSBE	FSBE	FSBE	FSBE	FSBE
Line 2	Pixel 1	Pixel 2	Pixel 3	Pixel 4	Pixel 5	Pixel 6	Pixel 7	Pixel 8
	Pixel 9	Pixel 10	Pixel 11	Pixel 12	Pixel 13	Pixel 14	Pixel 15	Pixel 16

	Pixel3833	Pixel3834	Pixel3835	Pixel3836	Pixel3837	Pixel3838	Pixel3839	Pixel3840

5.0 SIGNAL TIMING WAVEFORMS OF INTERFACE SIGNAL

5.1 Input Data Specification CN1

< Table 7. Vx1 Byte length and Color mapping >

Byte	Packer input	Color data mapping
		30 bpp RGB
0	Bit-0	R2
	Bit-1	R3
	Bit-2	R4
	Bit-3	R5
	Bit-4	R6
	Bit-5	R7
	Bit-6	R8
	Bit-7	R9
1	Bit-8	G2
	Bit-9	G3
	Bit-10	G4
	Bit-11	G5
	Bit-12	G6
	Bit-13	G7
	Bit-14	G8
	Bit-15	G9
2	Bit-16	B2
	Bit-17	B3
	Bit-18	B4
	Bit-19	B5
	Bit-20	B6
	Bit-21	B7
	Bit-22	B8
	Bit-23	B9
3	Bit-24	-
	Bit-25	-
	Bit-26	B0
	Bit-27	B1
	Bit-28	G0
	Bit-29	G1
	Bit-30	R0
	Bit-31	R1

5.2 Signal Timing Waveform

< Table 8. Signal Timing Table >

Parameter	Symbol	Condition	Min	Typ	Max	Unit
Unit Interval(VBO Operation Bit Rate)	tRBIT	3-byte	380	tTCIP/30	1667	PS
		4-byte	285	tTCIP/40	1250	PS
		5-byte	266	tTCIP/50	1000	PS
Eye Width at Package Pin	tREYE	-	-	0.5	-	UI
Eye Width Position A at Package Pin	tA	-	-	0.25	-	UI
Eye Width Position B at Package Pin	tB	-	-	0.3	-	UI
Eye Width Position Cat Package Pin	tC	-	-	0.7	-	UI
Eye Width Position D at Package Pin	tD	-	-	0.75	-	UI
Eye Width Position E at Package Pin	tE	-	-	0.7	-	UI
Eye Width Position F at Package Pin	tF	-	-	0.3	-	UI
Intra – pair Skew	TTOSK_intra	-	-	-	0.3	UI
Inter – pair Skew	TTOSK_inter	-	-	-	40	UI
SSCG	-					%

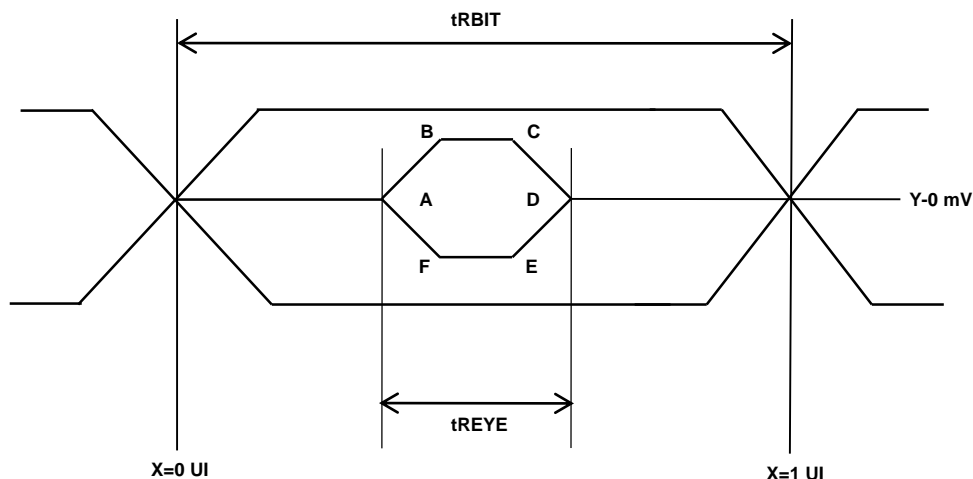

	Y[mV]
A	0
B	50
C	50
D	0
E	-50
F	-50

6.0 SIGNAL TIMING SPECIFICATION

6.1 Timing Parameters

< Table 9. Timing Table >

Item	Symbol		Min	Typ	Max	Unit
DCLK	Period	tCLK	12.5	13.47	15.1	ns
	Frequency	-	66	74.25	80	MHz
Horizontal	Horizontal Period (Total)	tHP	530	550	570	tCLK
	Horizontal Valid	tHV	480			tCLK
	Horizontal Blank	tHB	50	70	90	-
Vertical	Vertical Period (Total)	tVP	2180	2250	2450	tHP
	Vertical Valid	tVV	2160			tHP
	Vertical Blank	tVB	20	90	290	tHP
	Frequency	fV	57	60	63	Hz
VBO Receiver Clock	Input spread spectrum ratio	SSr	-0.5	-	+0.5	%
	Inter-Pair Skew	T _{RISK_Inter}	-5	-	5	UI

Note

1. While operation, DE signal should be have the same cycle. The input of HSYNC & VSYNC signal does not have an effect on normal operation (DE Only Mode, but the signals of Hsync and Vsync must be inputted even though this TCON is operated at DE Only Mode.

2. Best operation clock frequency is 74.25Mhz.

3. Except Best operation clock frequency, FOS(Flicker & Brightness & Crosstalk, Etc.) are not guaranteed.

4. Main frequency Max is 80MHz without spread spectrum

6.2 Input Signals, Basic Display Colors and Gray Scale of Colors

< Table 10. Input Signal and Display Color Table >

Color		Input Color Data																											
		MSB RED LSB										MSB GREEN LSB										MSB BLUE LSB							
		R9	R8	R7	R6	R5	R4	R3	R2	R1	R0	G9	G8	G7	G6	G5	G4	G3	G2	G1	G0	B9	B8	B7	B6	B5	B4	B3	B2
Basic Color	Black	0	0	0	0	0	0	0	0	0	0	0	0	0	0	0	0	0	0	0	0	0	0	0	0	0	0	0	0
	Red(1023)	1	1	1	1	1	1	1	1	1	0	0	0	0	0	0	0	0	0	0	0	0	0	0	0	0	0	0	0
	Green(1023)	0	0	0	0	0	0	0	0	0	1	1	1	1	1	1	1	1	1	1	1	0	0	0	0	0	0	0	0
	Blue(1023)	0	0	0	0	0	0	0	0	0	0	0	0	0	0	0	0	0	0	0	1	1	1	1	1	1	1	1	1
	Cyan	0	0	0	0	0	0	0	0	0	1	1	1	1	1	1	1	1	1	1	1	1	1	1	1	1	1	1	1
	Magenta	1	1	1	1	1	1	1	1	1	0	0	0	0	0	0	0	0	0	0	1	1	1	1	1	1	1	1	1
	Yellow	1	1	1	1	1	1	1	1	1	1	1	1	1	1	1	1	1	1	1	0	0	0	0	0	0	0	0	0
	White	1	1	1	1	1	1	1	1	1	1	1	1	1	1	1	1	1	1	1	1	1	1	1	1	1	1	1	1
R	RED(000)	0	0	0	0	0	0	0	0	0	0	0	0	0	0	0	0	0	0	0	0	0	0	0	0	0	0	0	
	RED(001)	0	0	0	0	0	0	0	0	1	0	0	0	0	0	0	0	0	0	0	0	0	0	0	0	0	0	0	

	RED(1022)	1	1	1	1	1	1	1	1	1	0	0	0	0	0	0	0	0	0	0	0	0	0	0	0	0	0	0	
	RED(1023)	1	1	1	1	1	1	1	1	1	0	0	0	0	0	0	0	0	0	0	0	0	0	0	0	0	0	0	
G	Green (000)	0	0	0	0	0	0	0	0	0	0	0	0	0	0	0	0	0	0	0	0	0	0	0	0	0	0	0	
	Green (000)	0	0	0	0	0	0	0	0	0	0	0	0	0	0	0	0	0	0	1	0	0	0	0	0	0	0	0	

	Green (1022)	0	0	0	0	0	0	0	0	0	1	1	1	1	1	1	1	1	1	0	0	0	0	0	0	0	0	0	
	Green (1023)	0	0	0	0	0	0	0	0	0	1	1	1	1	1	1	1	1	1	0	0	0	0	0	0	0	0	0	
B	Blue(000)	0	0	0	0	0	0	0	0	0	0	0	0	0	0	0	0	0	0	0	0	0	0	0	0	0	0	0	
	Blue(000)	0	0	0	0	0	0	0	0	0	0	0	0	0	0	0	0	0	0	0	0	0	0	0	0	0	0	1	

	Blue(1022)	0	0	0	0	0	0	0	0	0	0	0	0	0	0	0	0	0	0	1	1	1	1	1	1	1	1	0	
	Blue(1023)	0	0	0	0	0	0	0	0	0	0	0	0	0	0	0	0	0	0	1	1	1	1	1	1	1	1	1	

6.3 Power Sequence

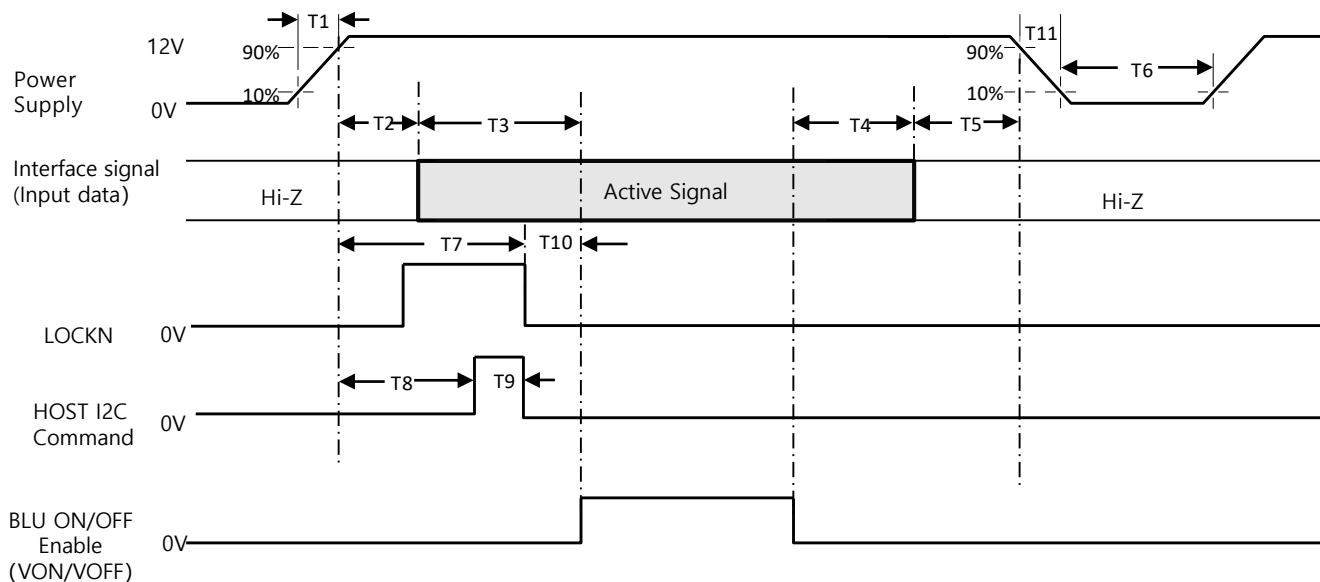

< Table 11. Sequence Table >

Parameter	Values			Units
	Min	Typ	Max	
T1	0.5	-	10	ms
T2	0	-	50	ms
T3	200	-	-	ms
T4	100	-	-	ms
T5	0	-	50	ms
T6	5	-	-	s
T7	-	-	200	ms
T8	1200	-	-	ms
T9	Depends on I2C command			
T10	300	-	-	ms
T11	-	-	10	Ms

Note 1: Even though T1 is over the specified value, there is no problem if the rush current is within Spec.

Note 2: When the power supply VDD is 0V, keep the level of input signals on the low or high impedance;

※ Please avoid floating state of interface signal at invalid period.

※ When the power supply for LCD (VDD) is off, be sure to pull down the valid and invalid data to 0V.

Note 3: The T3 / T4 is recommended value, the case when failed to meet a minimum specification, abnormal display would be shown. There is no reliability problem.

Note 4: T5 should be measured after the Module has been fully discharged between power off and on period

Note 5: Even though T7&T10 is over the specified value, please extend the time of Back Light on to ensure invalid data will not be seen.

Note 6: T11: Voltage of VDD must decay smoothly after power-off, there should be none re-bouncing voltage. (customer system decide this value)

6.3 Power Sequence

Sequence for converter

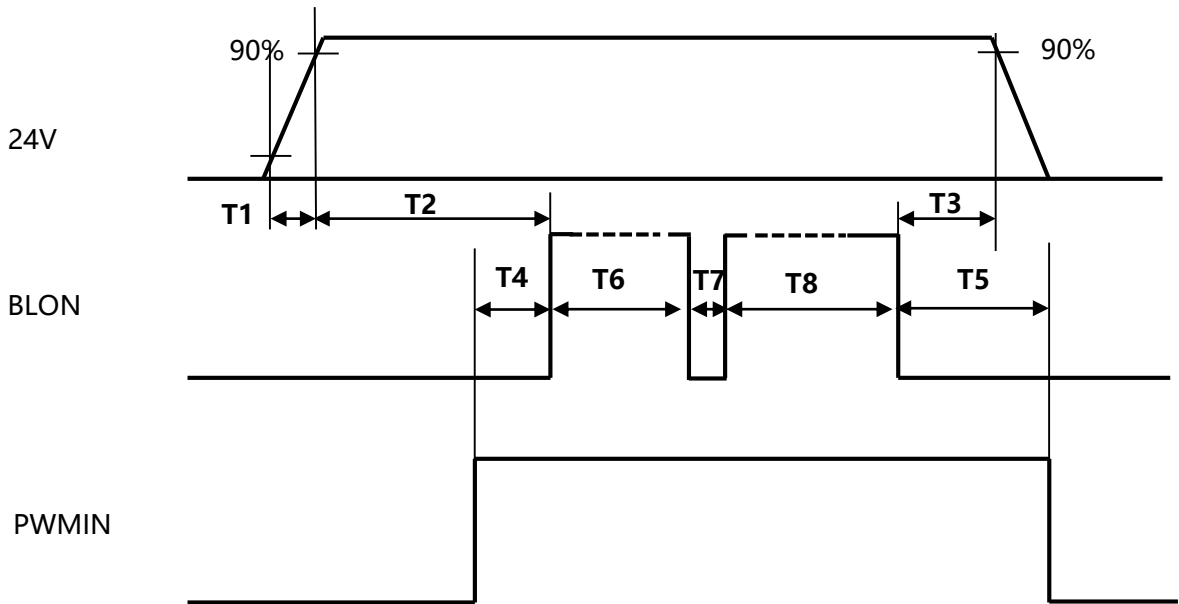

Input Voltage deep condition for converter

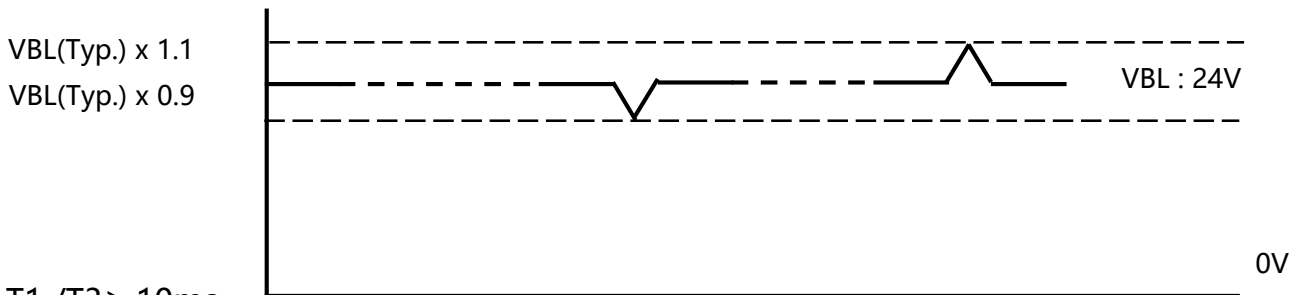

- $T1 / T3 \geq 10\text{ms}$
- $T2 \geq 200\text{ms}$
- $T4 / T5 \geq 0.1\text{ms}$
- $T6 / T8 \geq 2\text{sec}$
- $T7 \geq 500\text{ms}$

7.0 OPTICAL SPECIFICATIONS

The test of optical specifications shall be measured in a dark room (ambient luminance ≤ 1 lux and temperature $= 25 \pm 2^\circ\text{C}$) with the equipment of Luminance meter system (Goniometer system and PR730) and test unit shall be located at an approximate distance 180cm from the LCD surface at a viewing angle of θ and Φ equal to 0° . We refer to $\theta_{\phi=0}$ ($=\theta_3$) as the 3 o'clock direction (the "right"), $\theta_{\phi=90}$ ($=\theta_{12}$) as the 12 o'clock direction ("upward"), $\theta_{\phi=180}$ ($=\theta_9$) as the 9 o'clock direction ("left") and $\theta_{\phi=270}$ ($=\theta_6$) as the 6 o'clock direction ("bottom"). While scanning θ and/or ϕ , the center of the measuring spot on the Display surface shall stay fixed. The measurement shall be executed after 30 minutes warm-up period. VDD shall be 12.0V at 25°C . Optimum viewing angle direction is 6 o'clock.

< Table 12. Optical Table >

[VDD = 12.0V, Frame rate = 60Hz, Ta = $25 \pm 2^\circ\text{C}$]

Parameter		Symbol	Condition	Min	Typ	Max	Unit	Remark	
Viewing Angle	Horizontal	θ_3	CR > 10	-	89	-	Deg.		
		θ_9		-	89	-	Deg.		
	Vertical	θ_{12}		-	89	-	Deg.		
		θ_6		-	89	-	Deg.		
Contrast ratio		CR	$\theta = 0^\circ$ (Center) Normal Viewing Angle	800:1	1200:1	-		Note 2	
Brightness		Lv		2800	3500	-	nit	MDL	
White luminance uniformity		ΔY		75	-	-	%	Note 3	
Reproduction of color	White	W_x		TYP. - 0.03	TYP. + 0.03	0.311			Note 4
		W_y				0.327			
	Red	R_x				0.649			
		R_y				0.335			
	Green	G_x				0.311			
		G_y				0.625			
	Blue	B_x				0.154			
		B_y	0.057						
Color Gamut			68	72	-	%			
Response Time	G to G	T_g	-	10	14	ms	Note 4		

Note :

1. Viewing angle is the angle at which the contrast ratio is greater than 10. The viewing are determined for the horizontal or 3, 9 o'clock direction and the vertical or 6, 12 o'clock direction with respect to the optical axis which is normal to the LCD surface.
2. Contrast measurements shall be made at viewing angle of $\theta = 0^\circ$ and at the center of the LCD surface. Luminance shall be measured with all pixels in the view field set first to white, then to the dark (black) state. (See Figure 1 shown in Appendix) Luminance Contrast Ratio (CR) is defined mathematically.

$$CR = \frac{\text{Luminance when displaying a white raster}}{\text{Luminance when displaying a black raster}}$$

3. The color chromaticity coordinates specified in Table 9. shall be calculated from the spectral data measured with all pixels first in red, green, blue and white. Measurements shall be made at the center of the panel. The BLU is used by BOE.
4. Response time Tg is the average time required for display transition by switching the input signal as below table and is based on Frame rate fV =60Hz to optimize. Each time in below table is defined as Figure 2 and shall be measured by switching the input signal for "any level of gray(bright)" and "any level of gray(dark)".

Measured Response Time	Target																
	0	15	31	47	63	79	95	111	127	143	159	175	191	207	223	239	255
Start	0																
	15																
	31																
	47																
	63																
	79																
	95																
	111																
	127																
	143																
	159																
	175																
	191																
	207																
	223																
	239																
255																	

8.0 MECHANICAL CHARACTERISTICS

8.1 Dimensional Requirements

Figure 3(located in Appendix) shows mechanical outlines for the LCM DV750QUM-R11 . Other parameters are shown in Table 13.

< Table 13. Dimensional Parameters >

Parameter	Specification	Unit
Weight	30±1	KG
Active area	1649.664(H) × 927.936(V)	mm
Pixel pitch	429.6(H) × 429.6(V)	um
Number of pixels	3840(H) × 2160 (V) (1 pixel = R + G + B dots)	pixels

8.2 Mounting

See FIGURE 3. (shown in Appendix)

8.3 Anti-Glare and Polarizer Hardness.

The surface of the LCD has an anti-glare coating to minimize reflection and a coating to reduce scratching.

9.0 RELIABILITY TEST

The Reliability test items and its conditions are shown in below.

< Table 14. Reliability Test Parameters >

No	Test Items	Conditions
1	High temperature storage test	Ta = 80 °C, 240 hrs
2	Low temperature storage test	Ta = -30 °C, 240 hrs
3	High temperature & high humidity operation test	Ta = 50 °C, 80%RH, 240hrs
4	High temperature operation test	Ta = 60 °C, 240hrs
5	Low temperature operation test	Ta = -20°C, 240hrs
6	Thermal shock	Ta = -20 °C ↔ 60 °C (0.5 hr), 100 cycle
7	Electro-static discharge test (non-operating)	Air : 150 pF, 330Ω, ±15 KV Contact : 150 pF, 330Ω, ±8 KV

Note 1 : In the standard conditions, there is no function failure issue occurred.

10.0 PRODCUT SERIAL NUMBER

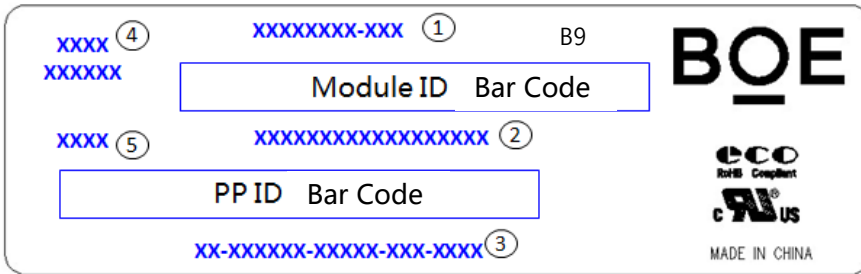

- ① FG Code
- ② Module ID, the last digit is Revision Code, the Code Rule of front 17 digits as the following description
- ③ PPID (Custom ID)
- ④ D/PN Code
- ⑤ Year & Week information

MDL ID Naming Rule:

Digit	1	2	3	4	5	6	7	8	9	10	11	12	13	14	15	16	17
Code	S	L	S	A	1	0	8	5	9	4	2	0	0	0	1	D	B
Description	Product Code/GBN→FG-CODE		Grade	line	Year	Month	Model Extension Code (Last 4 Digits of FG-CODE)				Serial No. Hex-Decimal 000000-FFFFFF						

11.0 PACKING INFORMATION

BOE provides the standard shipping container for customers, unless customer specifies their packing information. The standard packing method and Barcode information are shown in below.

11.1 Packing Order

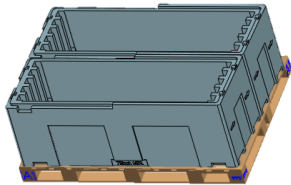

1. Put 2 ea Bottom on the pallet.

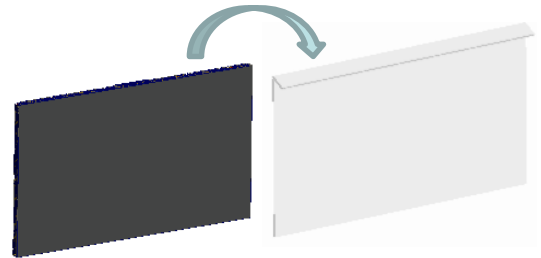

2. Put one MDL in the PE bag (PCB↓).

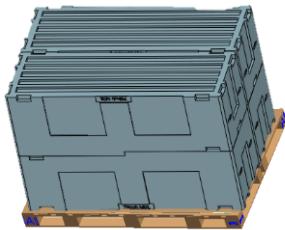

4. Put 2 ea Cover on the box

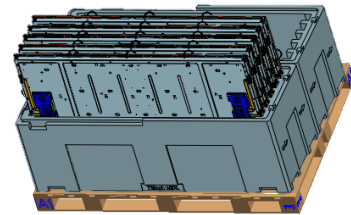

3. Put 5 Pcs MDL on the per box ,totally 10 Pcs MDL

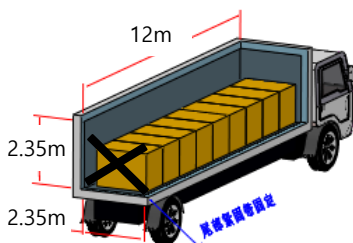

6. Transported by Truck (12m) : Stacked by One Layer

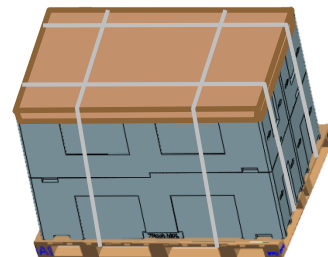

5. Put one Paper Cover on the Box and pack with wrap film,. Finally, pack with 4 packing belts.

11.2 Packing Note

- Box Dimension : 1844mm(L)×610mm(W)×1176mm(H)
- Package Quantity in one Box : 5pcs

11.3 Box Label

- Label Size : 110mm (L) × 55mm (W)

- Contents

Model : DV750QUM-R11

Q`ty : Module 5 Q`ty in one box

Serial No. : Box Serial No.

Date : Packing Date

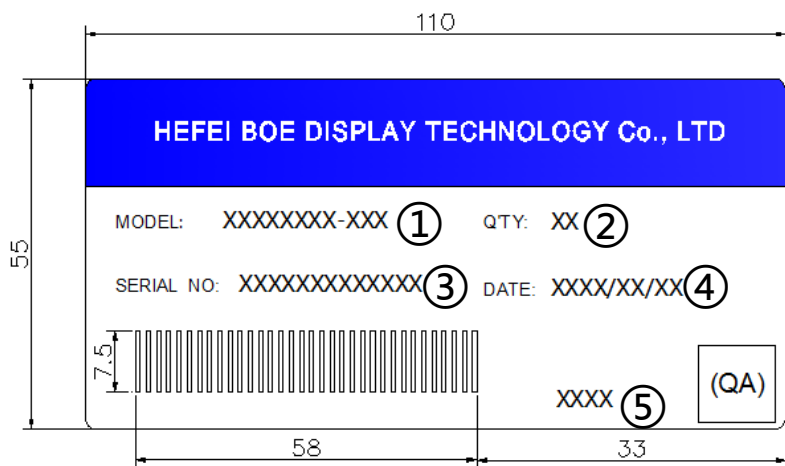

1. FG-CODE(Front 12Digits)
2. Packing Quantity
3. Box ID
4. Packing Date
5. FG-Code Last 4 Digits

Box ID Naming Rule:

Digit	1	2	3	4	5	6	7	8	9	10	11	12	13
Code	S	L	S	9	1	6	3	5	9	4	2	0	0
Description	Products GBN		Grade	Line	Year		Month	Revision Code	Serial No 00001- ZZZZZZ				

12.0 PRECAUTIONS

Please pay attention to the followings when you use this TFT LCD Module.

12.1 Mounting Precautions

- Use finger-stalls with soft gloves in order to keep display clean during the incoming inspection and assembly process.
- You must mount a module using specified mounting holes (Details refer to the drawings)
- You should consider the mounting structure so that uneven force (ex. Twisted stress, Concentrated stress) is not applied to the module. And the case on which a module is mounted should have sufficient strength so that external force is not transmitted directly to the module.
- Do not apply mechanical stress or static pressure on module; Abnormal display cause by pressing some parts of module during assembly process, do not belong to product failure, the press should be agreed by two sides.
- Determine the optimum mounting angle, refer to the viewing angle range in the specification for each model.
- Do not apply mechanical stress or static pressure on module, and avoid impact, vibration and falling.
- Acetic acid type and chlorine type materials for the cover case are not desirable because the former generates corrosive gas of attacking the polarizer at high temperature and the latter causes circuit break by electro-chemical reaction.
- Protection film for polarizer on the module should be slowly peeled off before display.
- Be careful to prevent water & chemicals contact the module surface.
- You should adopt radiation structure to satisfy the temperature specification.
- Do not touch, push or rub the exposed polarizers with glass, tweezers or anything harder than HB pencil lead. And please do not rub with dust clothes with chemical treatment. Do not touch the surface of polarizer for bare hand or greasy cloth. (Some cosmetics are detrimental to the polarizer.)
- When the surface becomes dusty, please wipe gently with absorbent cotton or other soft materials like chamois soaks with petroleum benzine. Normal-hexane & alcohol is recommended for cleaning the adhesives used to attach front / rear polarizers. Do not use acetone, toluene, because they cause chemical damage to the polarizer.
- Wipe off saliva or water drops as soon as possible. Their long time contact with polarizer causes deformations and color fading..

BOE	PRODUCT GROUP	REV	ISSUE DATE
	Customer SPEC	Rev. P1	2024/02/06

- This module has its circuitry PCB's on the rear side and Driver IC, should be handled carefully in order not to be stressed.
- Avoid impose stress on PCB and Driver IC during assembly process ,Do not drawing, bending, COF package & wire
- Do not disassemble the module.

12.2 Operating Precautions

- Do not connector or disconnect the cable to/from the Module at the “Power On” Condition.
- When the module is operating, do not lose CLK, ENAB signals. If any one of these signals is lost, the module would be damaged.
- Obey the supply voltage sequence. If wrong sequence is applied, the module would be damaged.
- Do not allow to adjust the adjustable resistance or switch
- The electrochemical reaction caused by DC voltage will lead to LCD module degradation, so DC drive should be avoided.
- The LCD modules use C-MOS LSI drivers, so customers are recommended that any unused input terminal would be connected to Vdd or Vss, do not input any signals before power is turn on, and ground you body, work/assembly area, assembly equipment to protect against static electricity.
- Do not exceed the absolute maximum rating value. (supply voltage variation, input voltage variation, variation in part contents and environmental temperature, and so on) Otherwise the Module may be damaged.
- Module has high frequency circuits. Sufficient suppression to the electromagnetic interference shall be done by system manufacturers. Grounding and shielding methods may be important to minimized the interference.
- Design the length of cable to connect between the connector for back-light and the converter as shorter as possible and the shorter cable shall be connected directly , The long cable between back-light and Converter may cause the Luminance of LED to lower and need a higher startup voltage
- The cables should be as short as possible between System Board and PCB interface.
- Connectors are precision devices to transmit electrical signals, and operators should plug in parallel
- Be careful for condensation at sudden temperature change. Condensation makes damage to polarizer or electrical contacted parts. And after fading condensation, smear or spot will occur.

SPEC. NUMBER S8-65-AA-213	SPEC. TITLE DV750QUM-R11 Product Specification Rev.P1	PAGE OF 38
------------------------------	--	---------------

12.3 Electrostatic Discharge Precautions

- Avoid the use work clothing made of synthetic fibers. We recommend cotton clothing or other conductivity-treated fibers.
- Since a module is composed of electronic circuits, it is not strong to electrostatic discharge. Make certain that treatment persons are connected to ground through wrist band etc.
- Do not close to static electricity to avoid product damage.
- Do not touch interface pin directly.

12.4 Precautions for Strong Light Exposure

- Do not leave the module operation or storage in Strong light . Strong light exposure causes degradation of polarizer and color filter.

12.5 Precautions for Storage

A. Atmosphere Requirement

ITEM	UNIT	MIN	TYP	MAX
Storage Temperature	(°C)	5	25	40
Storage Humidity	(%rH)	40	50	75
Storage Life	6 months			
Storage Condition	<ul style="list-style-type: none"> • The storage room should be equipped with a dark and good ventilation facility. • Prevent products from being exposed to the direct sunlight, moisture and water. • The product need to keep away from organic solvent and corrosive gas. • Be careful for condensation at sudden temperature change. • Storage condition is guaranteed under packing conditions. 			

B. Package Requirement

- The product should be placed in a sealed polythene bag.
- Product Should be placed on the pallet, Which is away from the floor, Be cautions not to pile the product up.
- The polarizer surface should not come in contact with any other object. It is recommended that they be stored in the container in which they were shipped.
- As the original protective film, do not use the adhesive protective film to avoid change of Pol color and characteristic.

12.6 Precautions for protection film

- Remove the protective film slowly, keeping the removing direction approximate 30-degree not vertical from panel surface, If possible, under ESD control device like ion blower, and the humidity of working room should be kept over 50%RH to reduce the risk of static charge.
- People who peeled off the protection film should wear anti-static strap and grounded well.

12.7 Appropriate Condition for Commercial Display

-Generally large-sized LCD modules are designed for consumer applications . Accordingly, long-term display like in Commercial Display application, can cause uneven display including image sticking. To optimize module's lifetime and function, several operating usages are required

1. Normal operating condition

- Temperature: $20 \pm 15^{\circ}\text{C}$
- Operating Ambient Humidity : $55 \pm 20\%$
- Display pattern: dynamic pattern (Real display)
- Well-ventilated place is recommended to set up Commercial Display system

2. Special operating condition

a. Ambient condition

- Well-ventilated place is recommended to set up Commercial Display system.

b. Power and screen save

- Periodical power-off or screen save is needed after long-term display.

c. As the low temperature, the response time is greatly delayed. As the high temperatures (higher than the operating temperature) the LCD module may turn black screen. The above phenomenon cannot explain the failure of the display. When the temperature returns to the normal operating temperature, the LCD module will return to normal display.

d. When expose to drastic fluctuation of temperature (hot to cold or cold to hot) ,the LCD module may be affected; Specifically, drastic temperature fluctuation from cold to hot ,produces dew on the LCD module 's surface which may affect the operation of the polarizer and LCD module

e. Do not exceed the absolute maximum rating value. (supply voltage variation, input voltage variation, variation in part contents and environmental temperature, and so on) Otherwise the Module may be damaged.

f. Products exposed to low temperature environment for a long time, need to carry out necessary protection , low temperature environment is usually refrigerators , vending machine Etc...

g. Long time and large angle forward use or unconventional use , It is strongly recommended to contact BOE for filed application engineering advice

h. Product reliability and functions are only guaranteed when the product is used under right operation usages. If product will be used in extreme conditions such as high temperature, high humidity, high altitude, special display images, running time, long time operation, outdoor operation, etc. It is strongly recommended to contact BOE for filed application engineering advice. Otherwise, its reliability and function may not be guaranteed. Extreme conditions are commonly found at airports, transit stations, banks, stock market and controlling systems.

3. Operating usages to protect against image sticking due to long-term static display.

a. Suitable operating time: under 20 hours a day.

b. Static information display recommended to use with moving image.

- Cycling display between 5 minutes' information(static) display and 10 seconds' moving image.

c. Background and character (image) color change

- Use different colors for background and character, respectively.

- Change colors themselves periodically.

d. Avoid combination of background and character with large different luminance.

1) Abnormal condition just means conditions except normal condition.

2) Black image or moving image is strongly recommended as a screen save

4. Lifetime in this spec. is guaranteed only when Commercial Display is used according to operating usages.

5. Module should be turned clockwise based on front view when used in portrait mode.

12.8 Other Precautions

A. LC Leak

- If the liquid crystal material leaks from the panel, it is recommended to wash the LC with acetone or ethanol and then burn it.
- If the liquid crystal material leaks from the panel, it should be kept away from the eyes or mouth. In case of contact with hands, skin or clothes, it has to be washed away thoroughly with soap.
- If LC in mouth, mouth need to be washed, drink plenty of water to induce vomiting and follow medical advice.
- If LC touch eyes, eyes need to be washed with running water at least 15 minutes.

B. Rework

- When returning the module for repair or etc., Please pack the module not to be broken. We recommend to use the original shipping packages.

13.0 APPENDIX 1

< Figure 1. Measurement Set Up >

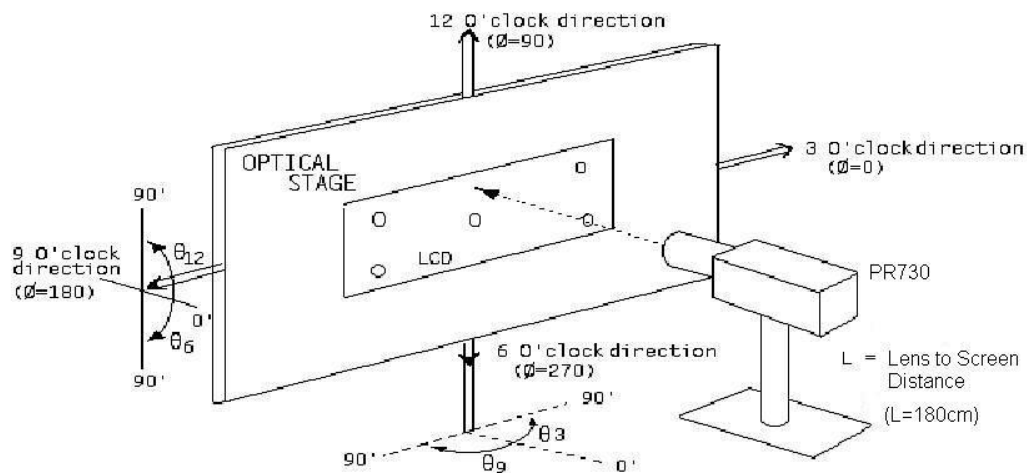

< Figure 2. Response Time Testing >

Any level of gray (Bright)

Any level of gray (Dark)

Any level of gray (Bright)

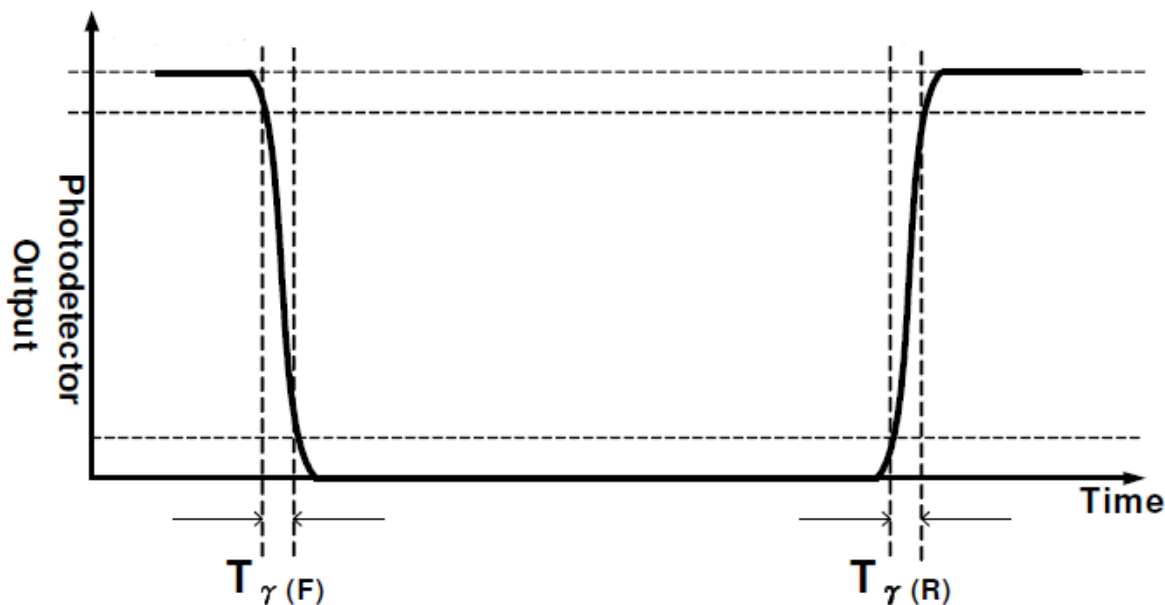

< Figure 3.TFT-LCD Module Outline Dimensions (Front View) >

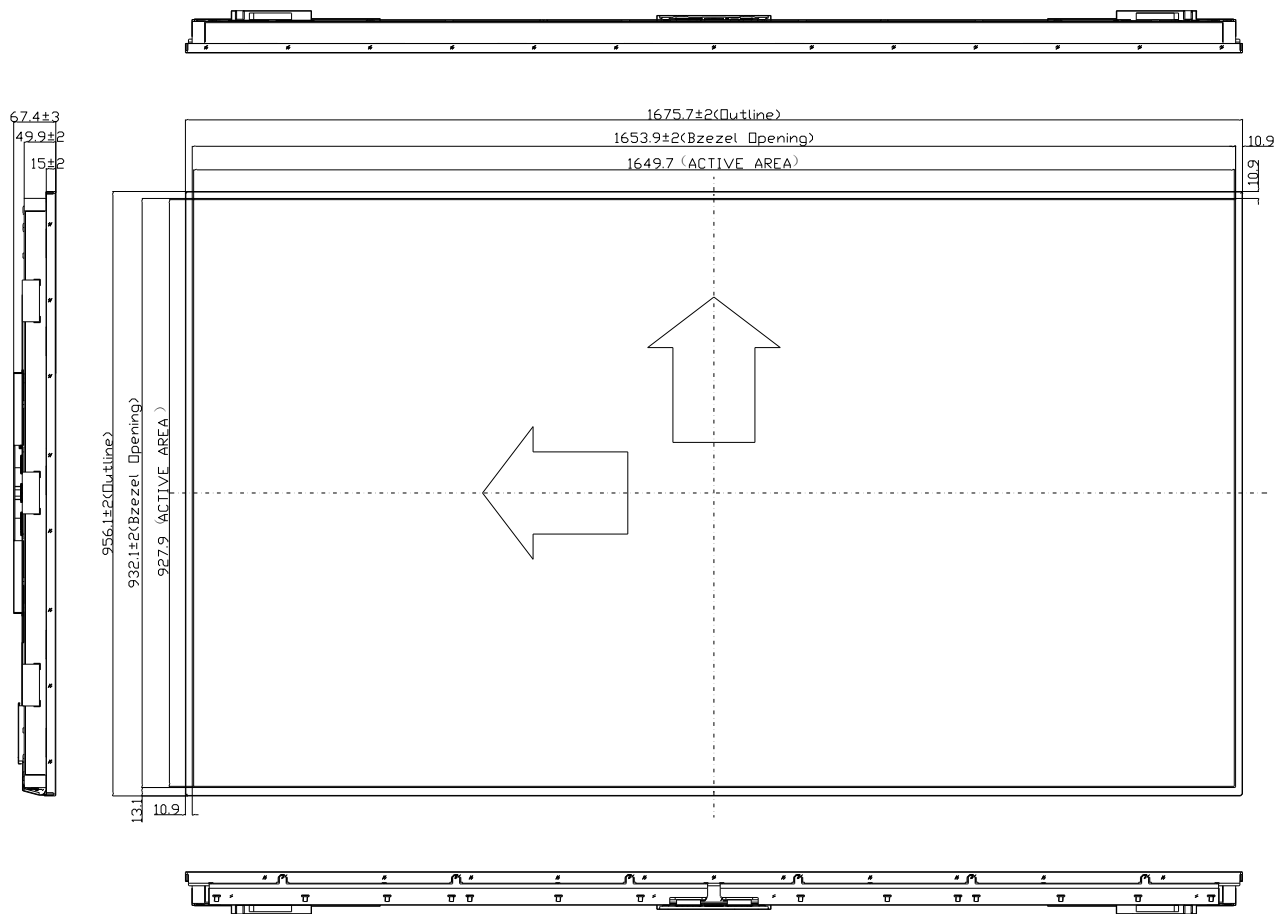

NOTE: Bezel black painting

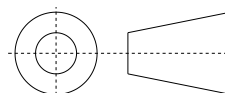

< Figure 4.TFT-LCD Module Outline Dimensions (Rear View) >

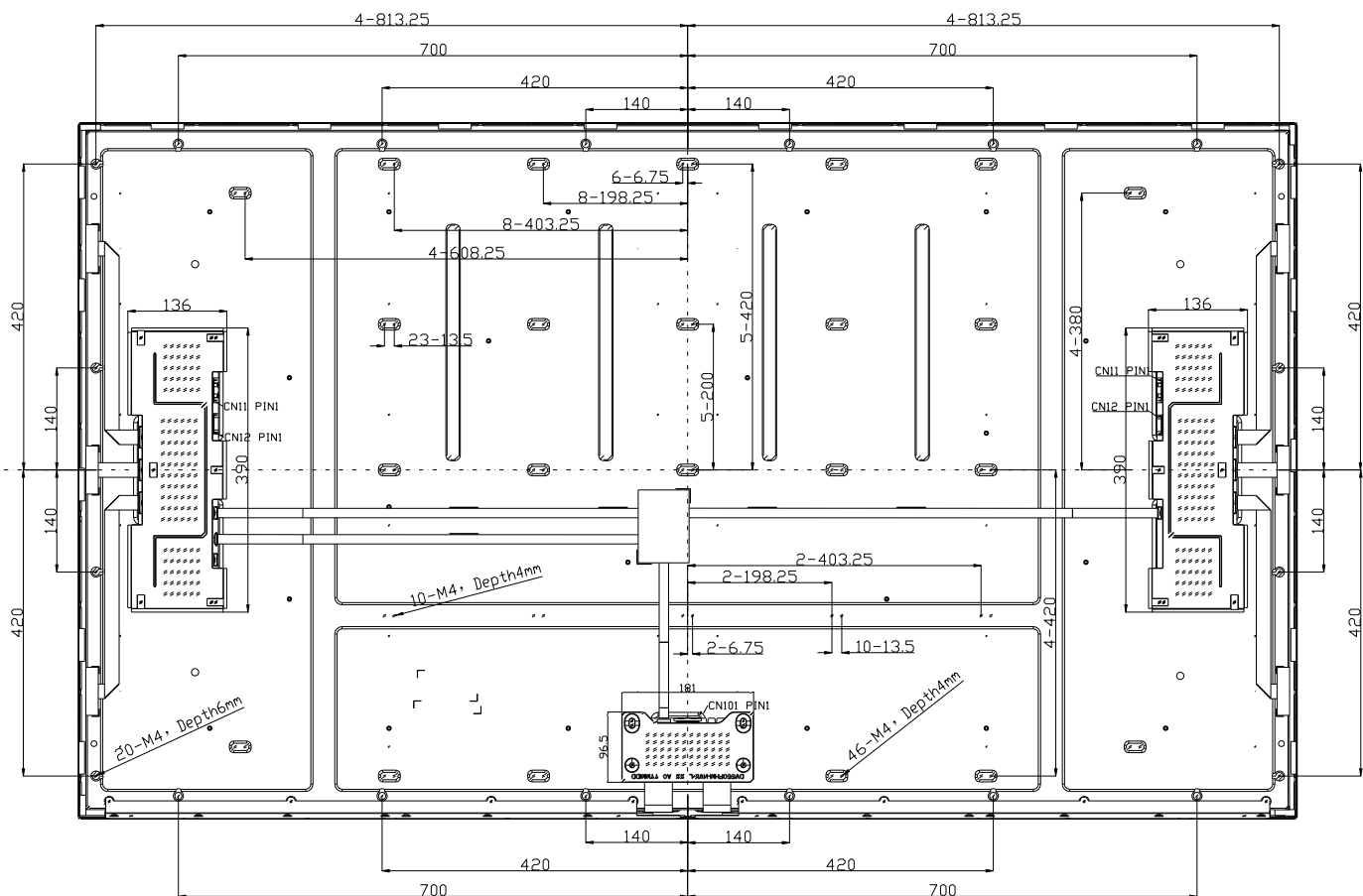

NOTE:

- 1.CN101 IS050-C51B-C39-S(UJU)
- 2.CN11 20022WR-14B2
- 3.CN12 20022WR-12
- 4.User Hole:10kgf.cm MAX

< Figure 5. White Luminance and Uniformity Measurement Locations >

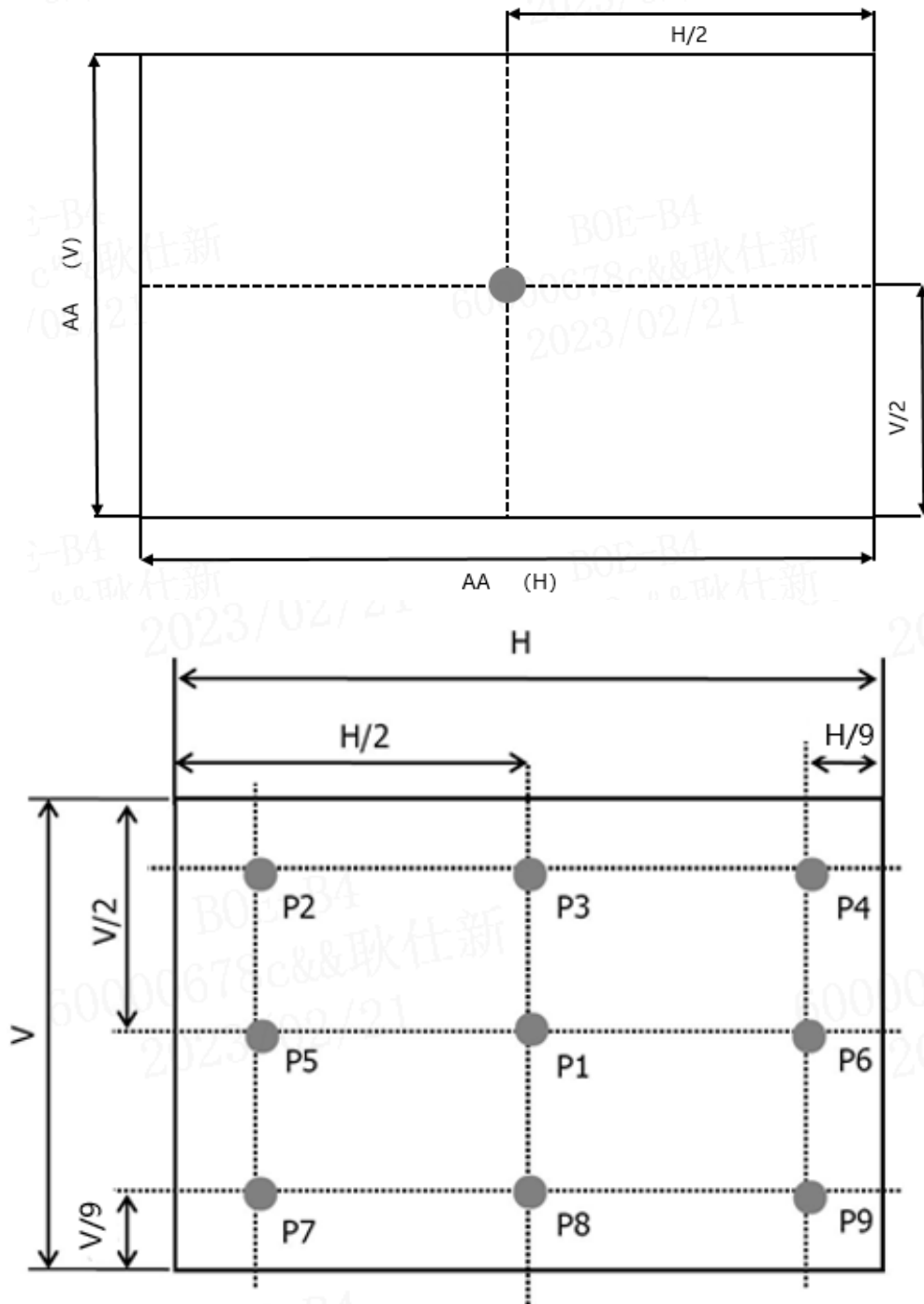

Our company network supports you worldwide with offices in Germany, Austria, Switzerland, the UK and the USA. For more information please contact:

Headquarters

Germany



FORTEC Elektronik AG

Augsburger Str. 2b
82110 Germering

Phone: +49 89 894450-0
E-Mail: info@forteca.de
Internet: www.forteca.de

Fortec Group Members

Austria



Distec GmbH Office Vienna

Nuschinggasse 12
1230 Wien

Phone: +43 1 8673492-0
E-Mail: info@distec.de
Internet: www.distec.de

Germany



Distec GmbH

Augsburger Str. 2b
82110 Germering

Phone: +49 89 894363-0
E-Mail: info@distec.de
Internet: www.distec.de

Switzerland



ALTRAC AG

Bahnhofstraße 3
5436 Würenlos

Phone: +41 44 7446111
E-Mail: info@altrac.ch
Internet: www.altrac.ch

United Kingdom



Display Technology Ltd.

Osprey House, 1 Osprey Court
Hichingbrooke Business Park
Huntingdon, Cambridgeshire, PE29 6FN

Phone: +44 1480 411600
E-Mail: info@displaytechnology.co.uk
Internet: www.displaytechnology.co.uk

USA



Apollo Display Technologies, Corp.

87 Raynor Avenue,
Unit 1 Ronkonkoma,
NY 11779

Phone: +1 631 5804360
E-Mail: info@apolloDisplays.com
Internet: www.apolloDisplays.com