

OUR GLOBAL  
COMPETENCE  
CENTRES

 APOLLO DISPLAY  
TECHNOLOGIES



 DISTEC



 DISPLAY  
TECHNOLOGY



# Datasheet

## Ampire

**AM-1280800P2TZQW-00H**

AM-10-001

The information contained in this document has been carefully researched and is, to the best of our knowledge, accurate. However, we assume no liability for any product failures or damages, immediate or consequential, resulting from the use of the information provided herein. Our products are not intended for use in systems in which failures of product could result in personal injury. All trademarks mentioned herein are property of their respective owners. All specifications are subject to change without notice.

---



晶采光電科技股份有限公司  
AMPIRE CO., LTD.

## SPECIFICATIONS FOR LCD MODULE

<b>CUSTOMER</b>	
<b>CUSTOMER PART NO.</b>	
<b>AMPIRE PART NO.</b>	<b>AM-1280800P2TZQW-00H</b>
<b>APPROVED BY</b>	
<b>DATE</b>	

- Approved For Specifications
- Approved For Specifications & Sample

**AMPIRE CO., LTD.**  
4F., No.116, Sec. 1, Xintai 5th Rd., Xizhi Dist., New Taipei City 221,  
Taiwan (R.O.C.)  
22181 新北市 汐止區 新台五路一段 116 號 4 樓(東方科學園區 A 棟)  
TEL:886-2-26967269 , FAX:886-2-26967196 or 26967270

APPROVED BY	CHECKED BY	ORGANIZED BY

## RECORD OF REVISION

Revision Date	Page	Contents	Editor
2015/12/14	--	New Release	Simon
2016/04/15	5	Correct <b>LED Driving Conditions</b>	Simon
2016/4/28		Correct ADJ Dimming data. Modify LVDS mapping data	Kokai
2016/08/12	20	Correct <b>OUTLINE DIMENSION</b>	Simon

## 1. Features

7 inch Amorphous-TFT-LCD (Thin Film Transistor Liquid Crystal Display) module. This module is composed of a 7" TFT-LCD panel and LED backlight and LED driving board.

- (1) Construction: 7" a-Si TFT active matrix, White LED Backlight.
- (2) Resolution (pixel): 1280(R.G.B) X800
- (3) Number of the Colors : 16.7M colors ( R , G , B 8 bit digital each)
- (4) LCD type :SFT with Normally Black

## 2. PHYSICAL SPECIFICATIONS

Item	Specifications	unit
LCD size	7 inch (Diagonal)	
Resolution	1280 x (RGB) x 800	dot
Dot pitch	0.117(H) x 0.117(V)	mm
Active area	149.76(W) x 93.6(H)	mm
Module size	162.2(W) x 107.8(H) x 9.8(D)	mm
Surface treatment(Up Polarizer)	HC	
Color arrangement	RGB-stripe	
Contrast Ratio	800:1	
Brightness	500	cd/m <sup>2</sup>

Note 1: Viewing direction for best image quality is different from Gray Scale Inversion Direction, there is a 180 degree shift.

### 3. ABSOLUTE MAX. RATINGS

#### 3.1 TFT Absolute Maximum Ratings

Item	Symbol	Values		UNIT	Note
		Min.	Max.		
Power voltage	VCC	-0.3	4.2	V	
	VLED	-0.3	14		
Operation temperature	TOP	-20	70	°C	
Storage temperature	TST	-30	80	°C	

### 4. ELECTRICAL CHARACTERISTICS

#### 4-1 Typical Operation Conditions

Item	Symbol	Values			Unit	Remark	
		MIN	TYP	MAX			
Power Voltage	V <sub>CC</sub>	3.0	3.3	3.6	V	Note 1,2	
Power Consumption	I <sub>CC</sub>	--	150	--	mA	Note 1,2 V <sub>CC</sub> =3.3V	
Logic Input Voltage	Input Voltage	V <sub>IN</sub>	0	-	V <sub>CC</sub>	V	
	Logic input high voltage	V <sub>TH</sub>	0.7V <sub>CC</sub>	-	V <sub>CC</sub>	V	Note 3
	Logic input low voltage	V <sub>TL</sub>	GND	-	0.3V <sub>CC</sub>	V	Note 3

Note 1: Value for Power Board combined panel.

Note 2: VCC setting should match the signals output voltage (refer to Note 3) of customer's system board.

Note 3: LVDS.

## 4-2 LED Driving Conditions

Item	Symbol	Values			Unit	Note
		Min.	Typ.	Max.		
LED Driver Power Voltage	$V_{LED}$	9	12	14	V	
LED Driver Current Consumption	$I_{LED}$	--	260	--	mA	$V_{LED}=12V$ $ADJ=5V$ (duty 100%)
ADJ Input Voltage	$V_{ADJ}$	1.2	3.3	3.6	V	duty=100% Note(3)
LED voltage	$V_{AK}$	--	21	--	V	Note(1)
LED forward Current	$I_{AK}$	--	120	--	mA	$T_a=25^{\circ}C$
LED life time	--	--	50,000	--	Hr	Note(2)

Note (1) The constant current source is needed for white LED back-light driving.

Note (2) Brightness to be decreased to 50% of the initial value.  $T_a=25^{\circ}C$

Note (3)  $V_{LEDADJ}$  is PWM signal input. It is for brightness control.

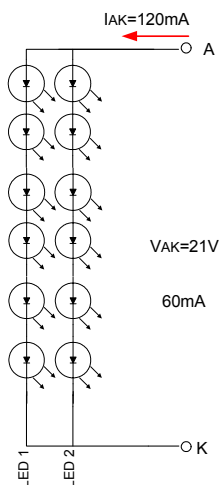

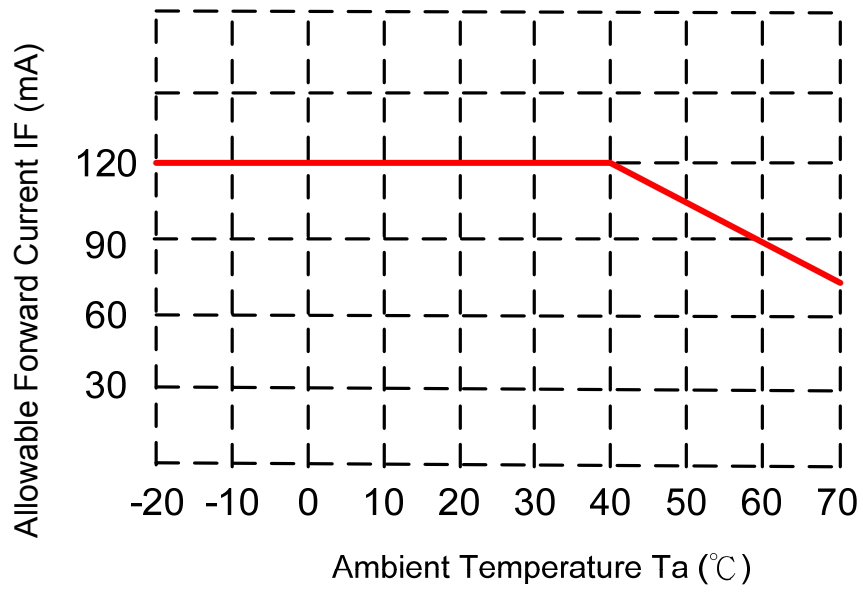



## 5. Timing Chart

### 5.1 AC Electrical Characteristics

Parameter	Symbol	Min	Typ	Max	Unit	Conditions
Clock Frequency	$R_{XFCLK}$	20	-	80	MHz	
Input data skew margin	$T_{RSKM}$	500	—	—	ps	$ V_{ID} =400mV$ , $R_{XVCM}=1.2V$ $R_{XFCLK}=80MHz$
Clock high time	$T_{LVCH}$	—	$4/(7 * R_{XFCLK})$	—	ns	
Clock low time	$T_{LVCL}$	—	$3/(7 * R_{XFCLK})$	—	ns	
PLL wake-up time	$T_{enPLL}$	—	—	150	us	

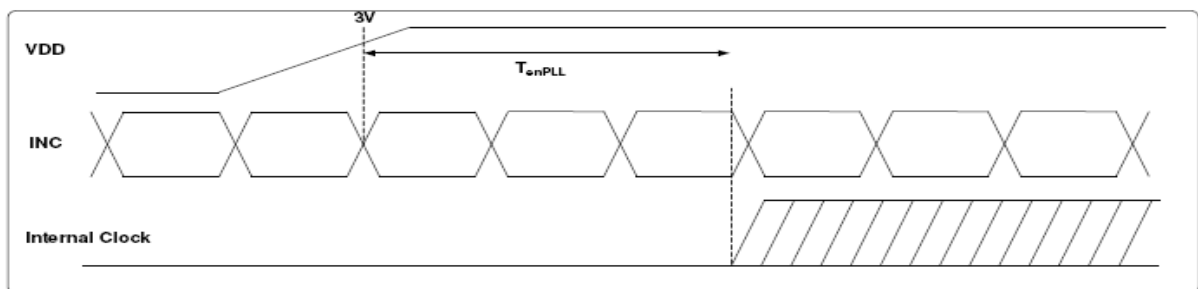
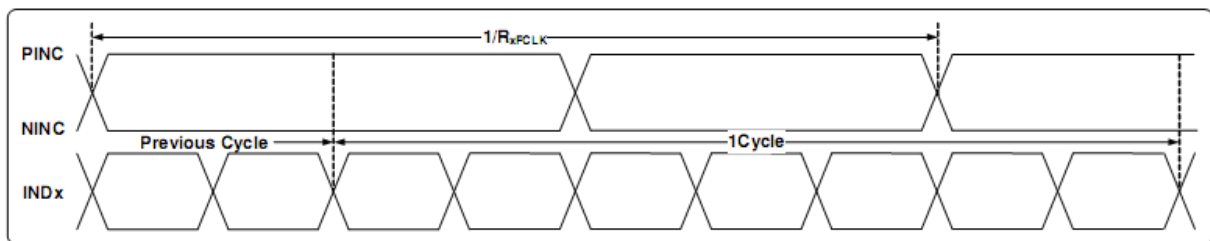

### 5.2 DC Electrical Characteristics

VDD=3.3V, AVDD=11V, AGND=GND=0V, Ta=25°C

Parameter	Symbol	Min	Typ	Max	Unit	Remark
Differential input high Threshold voltage	$R_{XVTH}$	-	-	+0.1	V	
Differential input Low Threshold voltage	$R_{XVTL}$	-0.1	-	-	V	
Input voltage range	$R_{XVIN}$	0	-	VDD-1.0	V	
Differential input common Mode voltage	$R_{XVCM}$	$ V_{ID} /2$	-	$2.4- V_{ID} /2$	V	

Differential input voltage	$ V_{ID} $	0.2	-	0.6	V	
LVDS Digital Operating Current	$R_{VXIZ}$	-10	-	+10	$\mu A$	
LVDS Digital Operating Current	$I_{ddlvds}$	-	(40)	(50)	mA	Fclk=65MHz, VDD=3.3V
LVDS Digital Stand-by Current	$I_{stlvds}$	-	(10)	(50)	$\mu A$	Clock & all functions are stopped

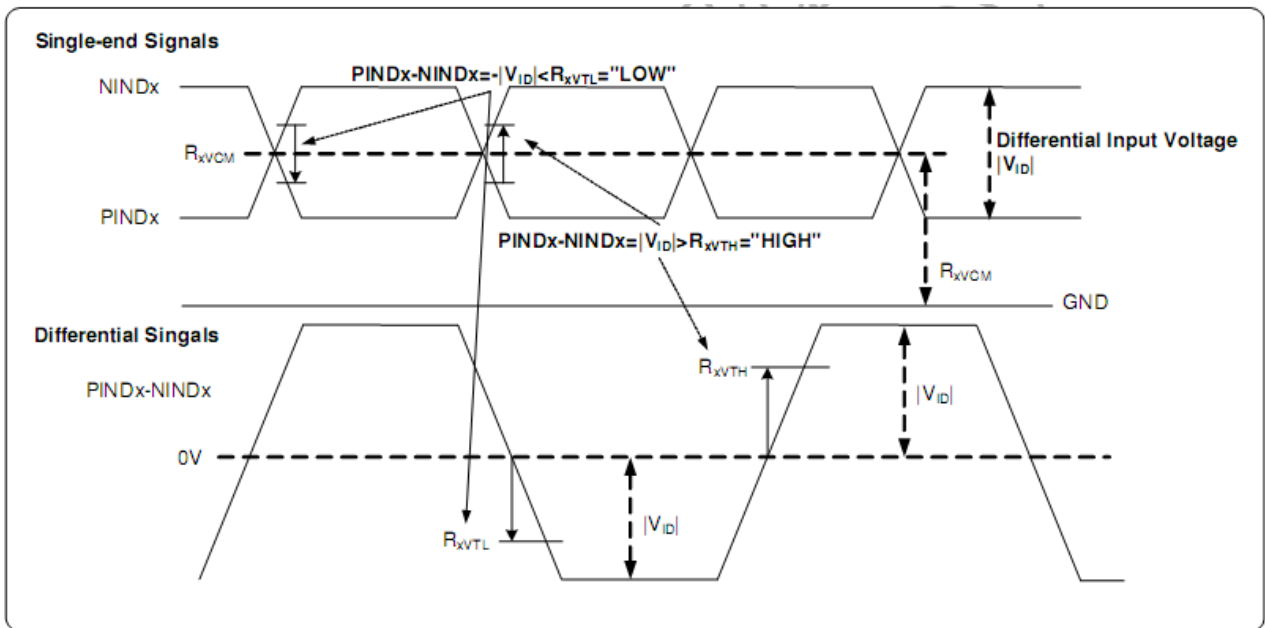

### 5.3 Input timing

1280x800 (RES[3:0] = 0010)

Parameter	Symbol	Value			Unit	Note
		Min.	Typ.	Max.		
CLK frequency	$t_{CLK}$	62.6	68.2	78.1	Mhz	
Horizontal blanking time	$t_{HBT}$	20	69	164	$t_{CLK}$	$t_{HBP} + t_{HFP}$
Horizontal back porch	$t_{HBP}$	5	5	$164 - t_{HFP}$	$t_{CLK}$	
Horizontal display area	$t_{HD}$	1280	1280	1280	$t_{CLK}$	
Horizontal front porch	$t_{HFP}$	15	64	159	$t_{CLK}$	
Horizontal period	$t_H$	1300	1349	1444	$t_{CLK}$	
Horizontal pulse width	$t_{HPW}$	1	1	256	$t_{CLK}$	
Vertical blanking time	$t_{VBT}$	5	42	101	$t_H$	$t_{VBP} + t_{VFP}$
Vertical back porch	$t_{VBP}$	2	2	$101 - t_{VFP}$	$t_H$	
Vertical display area	$t_{VD}$	800	800	800	$t_H$	
Vertical front porch	$t_{VFP}$	3	40	99	$t_H$	
Vertical period	$t_V$	803	842	901	$t_H$	
Vertical pulse width	$t_{VPW}$	1	1	128	$t_H$	

### 5.3 Data Input Format

#### Vesa data mapping : 24-BIT LVDS Input Data Format

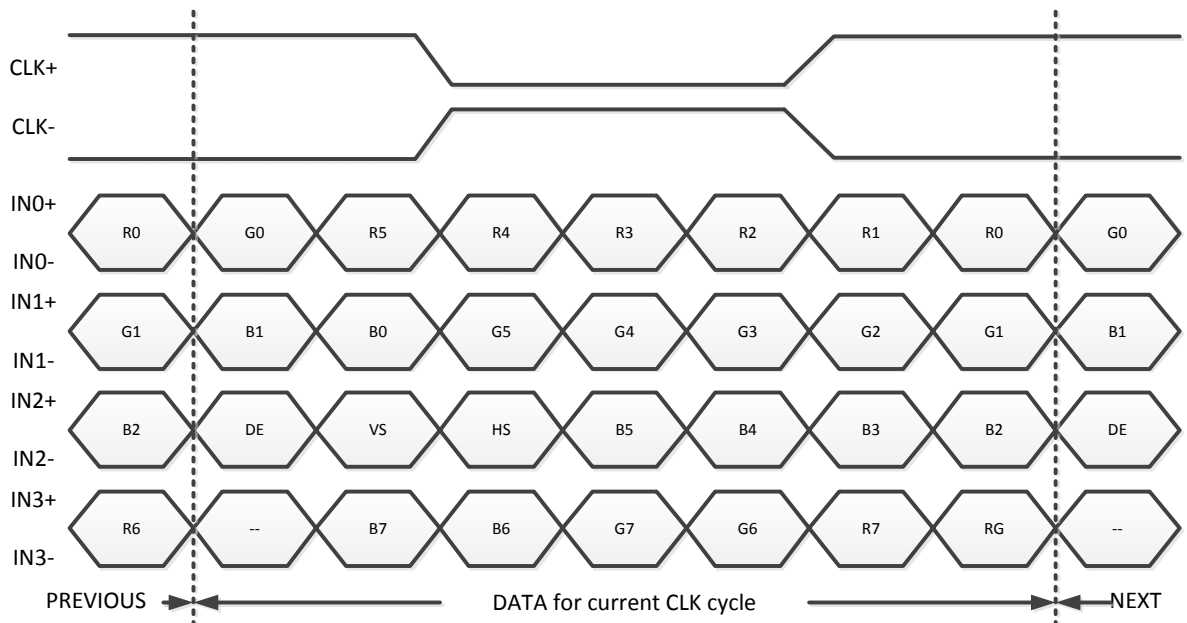

Note : R/G/B data 7 : MSB, R/G/B data 0 : LSB

Signal Name	Description	Remark
R7 R6 R5 R4 R3 R2 R1 R0	Red Data 7 (MSB) Red Data 6 Red Data 5 Red Data 4 Red Data 3 Red Data 2 Red Data 1 Red Data 0 (LSB)	Red-pixel Data Each red pixel's brightness data consists of these 8 bits pixel data.
G7 G6 G5 G4 G3 G2 G1 G0	Green Date 7 (MSB) Green Date 6 Green Date 5 Green Date 4 Green Date 3 Green Date 2 Green Date 1 Green Date 0 (LSB)	Green-pixel Data Each green pixel's brightness data consists of these 8 bits pixel data.
B7 B6 B5 B4 B3 B2 B1 B0	Blue Data 7 (MSB) Blue Data 6 Blue Data 5 Blue Data 4 Blue Data 3 Blue Data 2 Blue Data 1 Blue Data 0 (LSB)	Blue-pixel Data Each blue pixel's brightness data consists of these 8 bits pixel data.
RxCLKIN+ RxCLKIN-	LVDS Clock Input	
DE	Display Enable	
VS	Vertical Sync Signal	
HS	Horizontal Sync Signal	

## 6. Optical Specifications

### 6.1 TFT Optical Characteristics

Item	Symbol	Condition	Min	Typ	Max	Unit	Remark
View Angles	$\theta T$	$CR \geq 10$	70	80	-	Degree	Note 2
	$\theta B$		70	80	-		
	$\theta L$		70	80	-		
	$\theta R$		70	80	-		
Contrast Ratio	CR	$\theta = 0^\circ$	600	800	-		Left/right $0^\circ$ Top/bottom $5^\circ$
Response Time	$T_{ON}$	$25^\circ C$	-	35	40	ms	Note1 Note4
	$T_{OFF}$						
Chromaticity	White	x	0.256	0.306	0.356		Note5 Note1
		y	0.279	0.329	0.379		
	Red	x	0.520	0.570	0.620		
		y	0.280	0.330	0.380		
	Green	x	0.300	0.350	0.400		
		y	0.542	0.592	0.642		
	Blue	x	0.105	0.155	0.205		
		y	0.051	0.101	0.151		
Uniformity	U		70	75	-	%	Note1 · Note6
NTSC			45	50	-	%	
Luminance	L		400	500	-	cd/m <sup>2</sup>	Note7

Test Conditions:

1.  $I_F = 20mA$ (one channel), the ambient temperature is  $25^\circ C$ .
2. The test systems refer to Note 1 and Note2.

Note 1: Definition of optical measurement system.

The optical characteristics should be measured in dark room. After 10 Minutes operation, the optical properties are measured at the center point of the LCD screen. All input terminals LCD panel must be ground when measuring the center area of the panel.

Note 1 : Definition of optical measurement system.

The optical characteristics should be measured in dark room. After 30 minutes operation, the optical properties are measured at the center point of the LCD screen. (Response time is measured by Photo detector TOPCON BM-7, other items are measured by BM-5A/Field of view : 1° / Height : 500mm.)

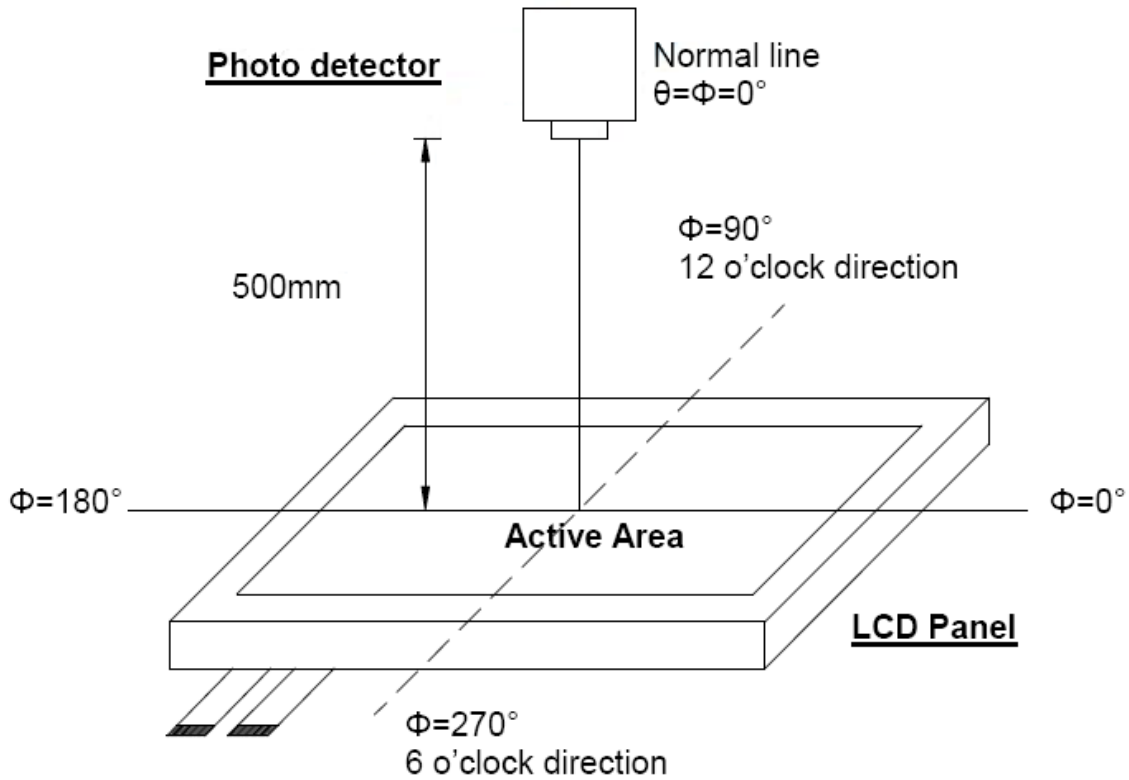

Note 2 : Definition of viewing angle range

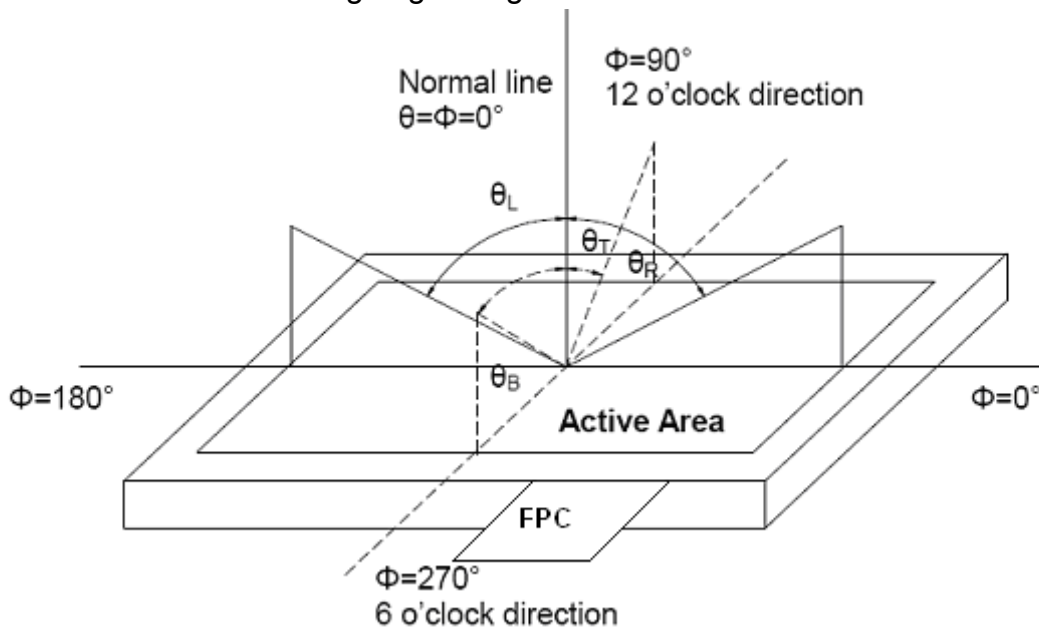

Note 3 : Definition of Response time

The response time is defined as the LCD optical switching time interval between “White” state and “Black” state. Rise time (T<sub>ON</sub>) is the time between photo detector output intensity changed from 90% to 10%. And fall time (T<sub>OFF</sub>) is the time between photo detector output intensity changed from 10% to 90%.

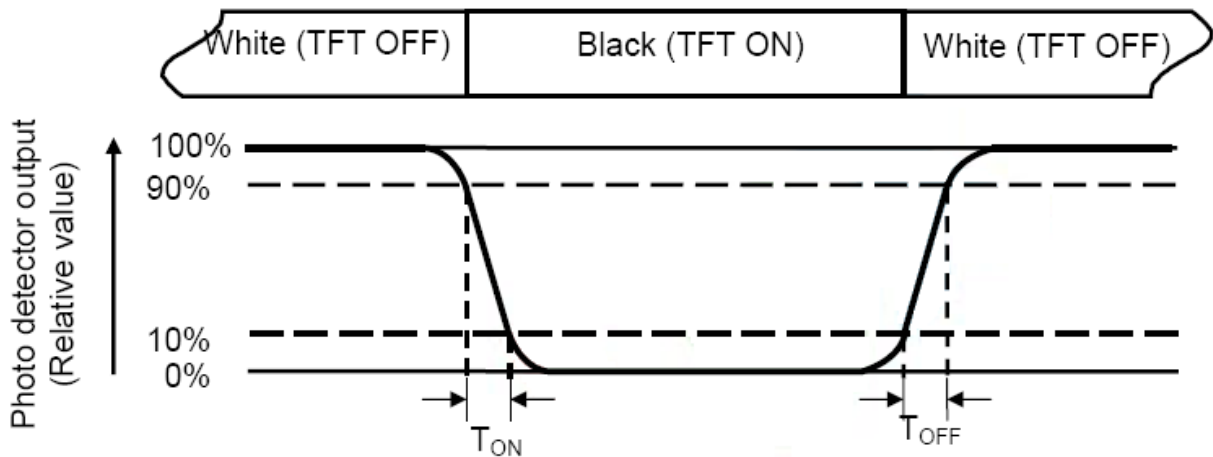

Note 4 : Definition of contrast ratio

$$\text{Contrast ratio (CR)} = \frac{\text{Luminance measured when LCD on the "White" state}}{\text{Luminance measured when LCD on the "Black" state}}$$

Note 5 : Definition of color chromaticity (CIE1931)

Color coordinated measured at center point of LCD.

Note 6 : All input terminals LCD panel must be ground when measuring the center area of the panel.

Note 7 : Definition of Luminance Uniformity

Active area is divided into 9 measuring areas (Refer to bellow figure). Every measuring point is placed at the center of each measuring area.

$$\text{Luminance Uniformity (Yu)} = \frac{B_{\min}}{B_{\max}}$$

L ----- Active area length      W ----- Active area width

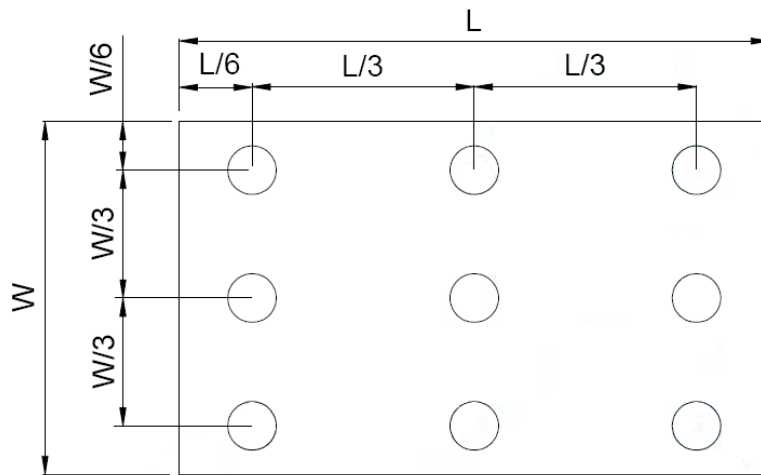

$B_{max}$  : The measured maximum luminance of all measurement position.

$B_{min}$  : The measured minimum luminance of all measurement position.



## 6. INTERFACE

CN2 LVDS connector: P1.0 20pin/CP100-S20G-H16

Pin No.	Symbol	I/O	Description	Note
1	VDD	P	Power Voltage for Logic: 3.3V	
2	VDD	P	Power Voltage for Logic: 3.3V	
3	GND	P	Ground	
4	GND	P	Ground	
5	IN0-	I	- LVDS differential data input	
6	IN0+	I	+ LVDS differential data input	
7	GND	P	Ground	
8	IN1-	I	- LVDS differential data input	
9	IN1+	I	+ LVDS differential data input	
10	GND	P	Ground	
11	IN2-	I	- LVDS differential data input	
12	IN2+	I	+ LVDS differential data input	
13	GND	P	Ground	
14	CLK-	I	- LVDS differential data input	
15	CLK+	I	+ LVDS differential data input	
16	GND	P	Ground	
17	IN3-	I	- LVDS differential data input	
18	IN3+	I	+ LVDS differential data input	
19	GND	P	Ground	
20	GND	P	Ground	

CN3 LED connector: ENTERY 3808K-F05N-03L

Pin No.	Symbol	I/O	Description	Note
1	VCC	P	Power Voltage for Backlight: 12V	
2	GND	P	Power Ground	
3	ON/OFF	I	Backlight ON/OFF, "H" LED ON.	
4	Dimming	I	PWM Adjust the LED brightness	
5	NA	-	No Connection	

NOTE : Pin4: Dimming is PWM signal input. It is for brightness control.

ITEM	SYMBOL	MIN	TYP	MAX	UNIT
ADJ(Dimming)signal frequency	$f_{PWM}$	5	--	100	KHz
ADJ signal logic level High	$V_{IH}$	1.2	3.3	3.6	V
ADJ signal logic level Low	$V_{IL}$	0	--	0.8	V

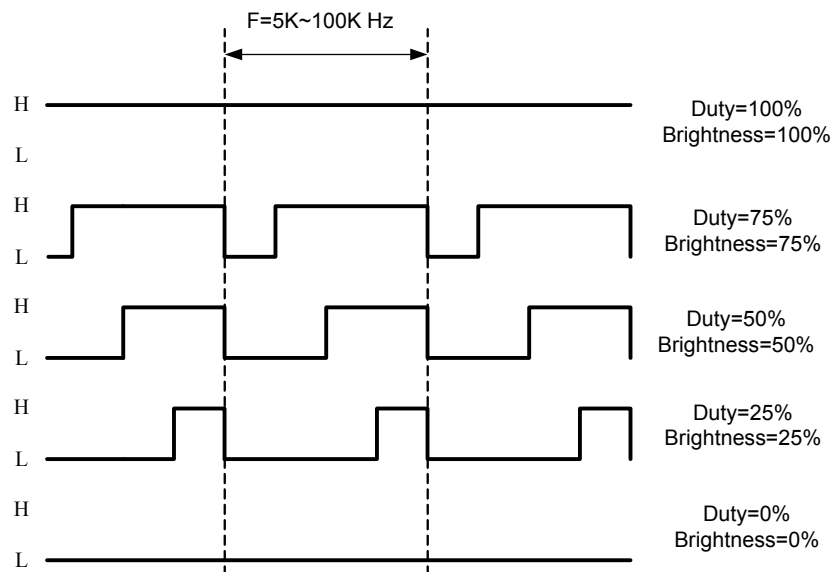

## 7. RELIABILITY TEST CONDITIONS

Test Item	Test Conditions	Note
High Temperature Operation	70±3°C , t=240 hrs	
Low Temperature Operation	-20±3°C , t=240 hrs	
High Temperature Storage	80±3°C , t=240 hrs	1,2
Low Temperature Storage	-30±3°C , t=240 hrs	1,2
Thermal Shock Test	-10°C ~ 60°C 30 min. ~ 30 min. ( 1 cycle ) Total 100cycle	1,2
Storage Humidity Test	60 °C, Humidity 90%, 240 hrs	1,2
Vibration Test (Packing)	Sweep frequency : 10 ~ 50 ~ 10 Hz/1min Amplitude : 0.75mm Test direction : X.Y.Z/3 axis Duration : 30min/each axis	2

Note 1: Condensation of water is not permitted on the module.

Note 2: The module should be inspected after 1 hour storage in normal conditions (15-35°C, 45-65%RH).

Definitions of life end point:

- Current drain should be smaller than the specific value.
- Function of the module should be maintained.
- Appearance and display quality should not have degraded noticeably.
- Contrast ratio should be greater than 50% of the initial value.

## **8. General Precautions**

### **8.1 Handling Precautions**

8.1.1 The display panel is made of glass. Do not subject it to a mechanical shock by dropping it from a high place, etc.

8.1.2 If the display panel is damaged and the liquid crystal substance inside it leaks out, be sure not to get any in your mouth, if the substance comes into contact with your skin or clothes, promptly wash it off using soap and water.

8.1.3 Do not apply excessive force to the display surface or the adjoining areas since this may cause the color tone to vary.

8.1.4 The polarizer covering the display surface of the LCD module is soft and easily scratched. Handle this polarizer carefully.

8.1.5 If the display surface is contaminated, breathe on the surface and gently wipe it with a soft dry cloth. If still not completely clear, moisten cloth with one of the following solvents:

— Isopropyl alcohol

— Ethyl alcohol

Solvents other than those mentioned above may damage the polarizer. Especially, do not use the following:

— Water

— Ketone

— Aromatic solvents

8.1.6 Do not attempt to disassemble the LCD Module.

8.1.7 If the logic circuit power is off, do not apply the input signals.

8.1.8 To prevent destruction of the elements by static electricity, be careful to maintain an optimum work environment.

a. Be sure to ground the body when handling the LCD Modules.

- b. Tools required for assembly, such as soldering irons, must be properly ground.
- c. To reduce the amount of static electricity generated, do not conduct assembly and other work under dry conditions.
- d. The LCD Module is coated with a film to protect the display surface. Be care when peeling off this protective film since static electricity may be generated.

## **8.2 Storage precautions**

8.2.1 When storing the LCD modules, avoid exposure to direct sunlight or to the light of fluorescent lamps.

8.2.2 The LCD modules should be stored under the storage temperature range.

If the LCD modules will be stored for a long time, the recommend condition is:

Temperature : 0°C ~ 40°C

Relatively humidity: ≤80%

8.2.3 The LCD modules should be stored in the room without acid, alkali and harmful gas.

**8.3 The LCD modules should be no falling and violent shocking during transportation, and also should avoid excessive press, water, damp and sunshine.**

# 9. OUTLINE DIMENSION

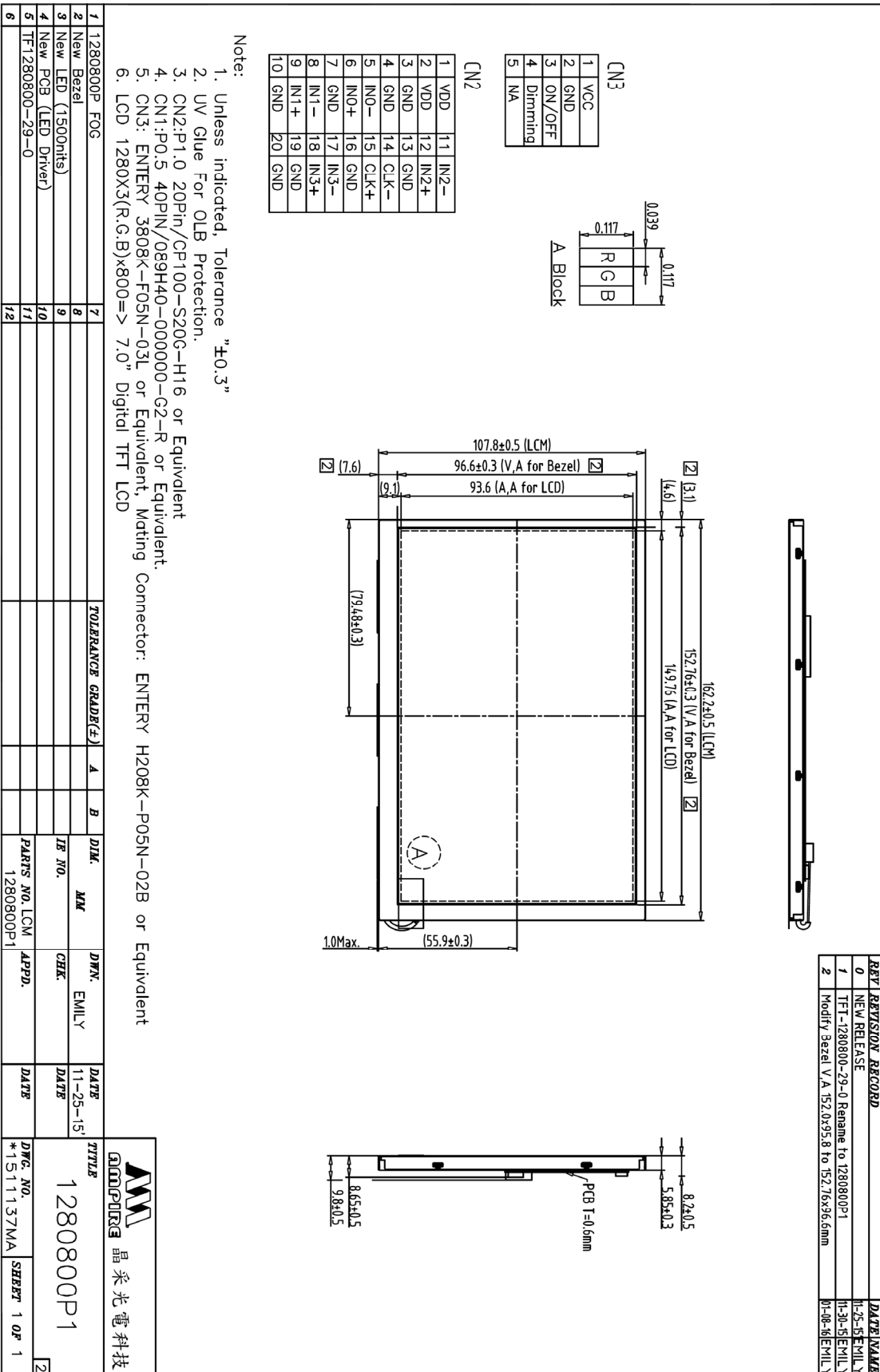

REV	REVISION RECORD	DATE	NAME
0	NEW RELEASE	11-25-15	EMILY
1	TFT-1280800-29-0 Rename to 1280800P1	11-30-15	EMILY

CN3

1	VCC
2	GND
3	ON/OFF
4	Dimming
5	NA

CN2

1	VDD	11	IN2-
2	VDD	12	IN2+
3	GND	13	GND
4	GND	14	CLK-
5	IND-	15	CLK+
6	IND+	16	GND
7	GND	17	IN3-
8	IN1-	18	IN3+
9	IN1+	19	GND
10	GND	20	GND

Note:  
 1. Unless indicated, Tolerance "±0.3"  
 2. UV Glue For OLB Protection.

- CN2:P1.0 20Pin/CP100-S20G-H16 or Equivalent
- CN1:P0.5 40Pin/089H40-000000-G2-R or Equivalent.
- CN3: ENTERY 3808K-F05N-03L or Equivalent, Mating Connector: ENTERY H208K-POSN-02B or Equivalent
- LCD 1280X3(R.G.B)X800=> 7.0" Digital TFT LCD

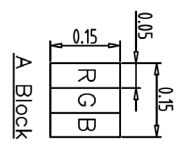
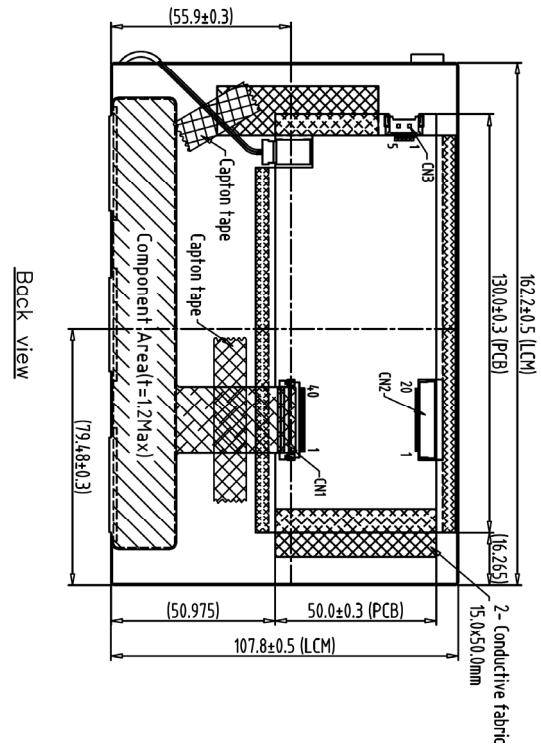

1	1280800P FOG	7	7	TOLERANCE GRADE(%)	A	B	DIM.	MM	DRAW.	EMILY	DATE	DATE	DWG. NO.	SHEET	1 OF 1
2	New Bezel	8	8								11-25-15		1280800P1	1	
3	New LED (1500nits)	9	9												
4	New PCB (LED Driver)	10	10												
5	TFT1280800-29-0	11	11												
6	TFT1280800-29-0	12	12												

**晶采光電科技**  
 TITLE  
**1280800P1**  
 DWG. NO. \*1511138MA SHEET 1 OF 1

Our company network supports you worldwide with offices in Germany, Austria, Switzerland, the UK and the USA. For more information please contact:

## Headquarters

Germany



**FORTEC Elektronik AG**

Lechwiesenstr. 9  
86899 Landsberg am Lech

Phone: +49 8191 91172-0  
E-Mail: [sales@forteca.de](mailto:sales@forteca.de)  
Internet: [www.forteca.de](http://www.forteca.de)

## Fortec Group Members

Austria



**FORTEC Elektronik AG**

**Office Vienna**

Nuschinggasse 12  
1230 Wien

Phone: +43 1 8673492-0  
E-Mail: [office@fortec.at](mailto:office@fortec.at)  
Internet: [www.fortec.at](http://www.fortec.at)

Germany



**Distec GmbH**

Augsburger Str. 2b  
82110 Germering

Phone: +49 89 894363-0  
E-Mail: [info@distec.de](mailto:info@distec.de)  
Internet: [www.distec.de](http://www.distec.de)

Switzerland



**ALTRAC AG**

Bahnhofstraße 3  
5436 Würenlos

Phone: +41 44 7446111  
E-Mail: [info@altrac.ch](mailto:info@altrac.ch)  
Internet: [www.altrac.ch](http://www.altrac.ch)

United Kingdom



**Display Technology Ltd.**

Osprey House, 1 Osprey Court  
Hichingbrooke Business Park  
Huntingdon, Cambridgeshire, PE29 6FN

Phone: +44 1480 411600  
E-Mail: [info@displaytechnology.co.uk](mailto:info@displaytechnology.co.uk)  
Internet: [www.displaytechnology.co.uk](http://www.displaytechnology.co.uk)

USA



**Apollo Display Technologies, Corp.**

87 Raynor Avenue,  
Unit 1 Ronkonkoma,  
NY 11779

Phone: +1 631 5804360  
E-Mail: [info@apolloDisplays.com](mailto:info@apolloDisplays.com)  
Internet: [www.apolloDisplays.com](http://www.apolloDisplays.com)