

User Manual

XTRA-Line Bartype 37



XTRA-Line Bartype monitors

93,98 cm (37")



Copyright

The contents of this manual are subject to change without notice.

© 2021 Distec GmbH. All rights reserved.

Reproduction of this manual in parts or entirely without the previous authorization of Distec is prohibited.

Distec is not liable for errors and collateral or subsequent damage which result from supply, deployment or any other utilisation of this document.

All product names mentioned in this document are trademarks or registered trademarks of their due owners.

Table of Contents

1. General Specifications	4
2. Scope of Delivery	5
3. General Safety Regulations	6
4. First Installation.....	9
5. Ambient Light Sensor	14
6. XTRA-Line Bartype 37 PME.....	15
7. XTRA-Line Bartype 37 IoT	23
8. Maintenance	26
9. Guarantee / Service	26
10. Disposal	28
11. Declaration of Conformity	29

1. General Specifications

Scope of Document

This user manual is valid for all XTRA-Line bartype monitors with a diagonal of 93.98 cm (37"). XTRA-Line bartype monitors are offered with various controllers and other options.

Important note: This user manual is complemented by other additional documents when indicated.

All documents are also available for download from Data Display Group web site: www.distec.de/en/service/downloads/monitor-downloads/.

XTRA-Line bartype monitor versions:

XTRA-Line 37 Bartype High Bright Video PME:: Monitor with integrated AD converter board, 1 x RGB, 1 x HDMI, 1 x Display Port.

XTRA-Line 37 Bartype Video PME:: Monitor with integrated AD converter board, 1 x RGB, 1 x HDMI, 1 x Display Port.

XTRA-Line 37 Bartype High Bright IoT: Monitor with integrated Raspberry® Pi CM3+ ARM Modul

XTRA-Line 37 Bartype IoT: Monitor with integrated Raspberry® Pi CM3+ ARM Modul

2. Scope of Delivery

When unpacking the monitor, please check if the following accessories are included in the shipment:



Note: Pictures can differ from actually supplied products.

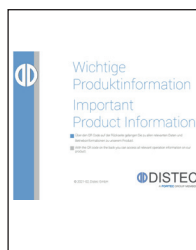

Product information



DP cable**



Power cable*



Remote control



ALS sensor***



Cable for ALS***

* Cable may vary depending on country

** for monitors of PME series only

*** for HB version with 2500 cd only

3. General Safety Regulations

Safety information

Please read this safety information carefully for your personal safety and for the prevention of property damage.

In case of a malfunction immediately disconnect the power plug and contact your dealer or the next Data Display Group service center. A malfunction is also considered if the housing, a control element or cable is damaged or if liquids or other objects penetrate the monitor.

Please read the safety information carefully before installing devices. If you have any doubts about whether the device may be used in a particular environment, please contact our service partner.

Repairs

Repairs may only be carried out by authorized technical personnel. Unauthorized access or improper repairs might cause serious property damage or cause danger to the user. In addition to that, any legitimate warranty claim expires.

Electrical connection

Disconnect the monitor from mains before carrying out any work. Do not touch or connect data cables or power cables during thunderstorms.

System start-up

Before system start-up slowly adjust the monitor temperature to the ambient temperature. Do not expose device to direct heat radiation. In case of condensation, please wait minimum 12 hours before setting the monitor into operation. The monitor may only be installed and operated as described in this documentation or the corresponding data sheets. Only qualified personnel may carry out the initial installation and system start-up.

Qualified personnel

Qualified personnel, in terms of the safety information of this documentation, are persons who are qualified to activate, ground and label devices, systems and circuits according to the safety standards.

Operation

For a trouble-free and safe operation of the product, adequate transportation, storage, installation and assembly as well as careful handling and maintenance are essential. The device is only certified for in-door operation. Avoid extreme ambient conditions. Protect the monitor from dust, humidity and heat. Do not expose the monitor to direct sunlight.

Transport

Unpack the monitor at place of installation. Use only original packaging for transportation. Please observe these rules for any later transport.

Condensation

Avoid condensation during transport at low temperatures or at extreme fluctuations of temperature.

Safety guidelines for the handling of LCD monitors



- If the device is not in use over a longer period of time, unplug the power cable.
- To unplug the device without problems, sockets have to be easily accessible.
- Do not unplug the power cable while the device is powered on, except for emergencies.
- Ensure that the power cable does not get pinched or kinked.
- Do not place heavy objects on the power cable.

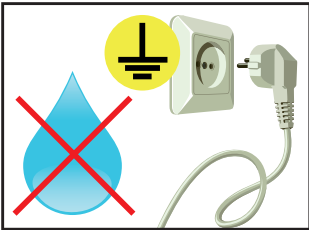

- Do not use damaged or loose sockets to plug in the device.
- Plug the device in earthed sockets only.
- Operate the device with our power cables included in the delivery only.
- Use undamaged power cables only.
- When plugging in and out, do not touch the power cable with wet hands.
- Ensure that the power cable is plugged in the socket safely and correctly.

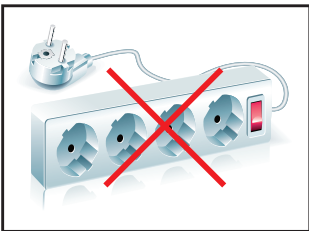

- Do not use multiple sockets to plug several devices into a single socket.



- According to size, devices may be difficult to handle and very heavy. Ensure that at least two people lift and carry the device.
- Put down the device slowly and carefully to avoid damaging the LCD screen. Ensure that the device stands stable.
- Keep packaging away from children. Danger of suffocation!
- Use our specified and professionally mounted wall mounting only.



- Do not put objects onto the device.
- Do not place candles, heaters or humidifier near the device.
- Keep the device away from fireplaces and flammable materials.

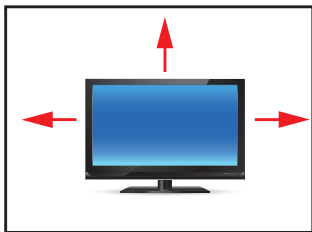

- Ensure sufficient ventilation of the device.
- Keep a minimum distance of at least 10 mm devices to the wall, for devices with integrated PC of at least 40 mm.
- Pay attention to the compliance with the operating temperature.

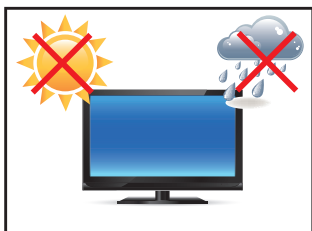

- Do not install the device in places where it is exposed to environmental impacts such as rain or direct sunlight.
- Do not install the device in places where it is exposed to high humidity, dust or smoke. In case of doubt, please contact your sales partner.



- Please use a soft, moist cloth for cleaning.
- For cleaning the screen, please only use commercially available screen cleaner. Do not spray the cleaner onto the device directly but onto a cloth.
- Please clean ventilation slots regularly to ensure a good air circulation.

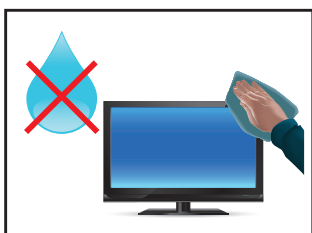

- Protect your device from splash water.
- When cleaning, please make sure that no liquids get into the device.
- Screens and surfaces can be scratched easily. Therefore, please use the prescribed cloth only.



- Caution high voltage! Never open the device yourself.
- In case of unusual noises, burnt smell or smoke unplug the power cable.
- Do not insert objects into the device through the ventilation slots.
- If the same picture is displayed over a longer period of time, an after-image may arise.
- When exchanging batteries of remote control, pay attention to the polarity. Keep batteries away from children and ensure an environmentally correct disposal.

4. First Installation

Position of connectors and controls

All the connectors for power and cables are located at the bottom of the back side of the display. The OSD keyboard is located at the top of the back side.



Position of the OSD keyboard



Position of the connectors for power (right)

Position of the connector for ambient light sensor (ALS if 2500 cd panel) and signal cables (left)

Position of the OSD keyboard (middle/ bottom)

Mounting with VESA compliant monitor brackets

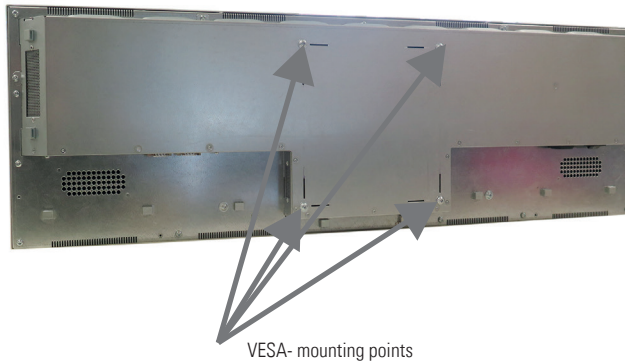

VESA- mounting points

The XTRA Line monitor has an integrated VESA mounting.

The operating position of the device is perpendicular (90 degrees to the floor). For wall mounting, the permissible tilt angle is observed.

VESA formats:
VESA 200x200

Mounting on wall

Distance to wall:

- device without integrated PC: min. 10 mm

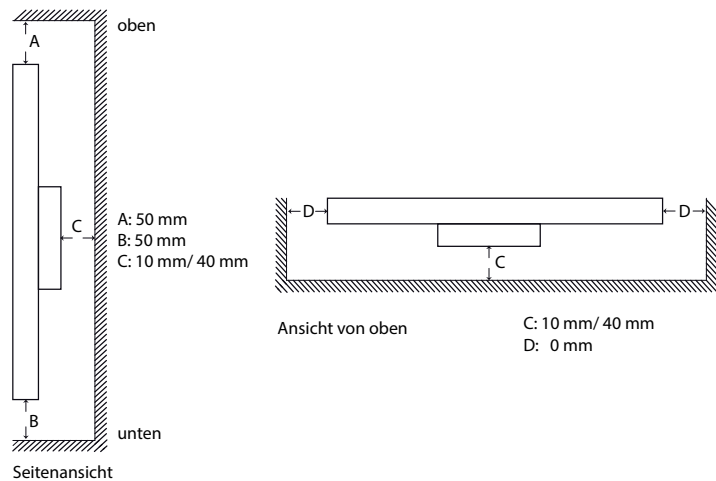

Mounting with VESA compatible brackets

The XTRA-Line bartype monitors are optionally supplied with mounting brackets. Alternatively, the monitor can be mounted with the wall bracket in landscape and portrait format. When using the wall bracket, the prescribed clearances to the rear of the monitor are observed.

The operating position of the device is perpendicular (90 degrees to the floor). Pay attention to the permissible tilt angle for wall mounting.

The device can be operated both in landscape mode and in portrait mode. The information is for positioning to note on the back of the device, always.

The wall bracket is designed for the load of the monitor including the options offered. Additional parts / components that are not available as an option for the XTRA-Line Bartype 37 must not be installed when using the wall bracket. For fastening to the VESA brackets, use 4 metal screws of size M6x25.



VESA standards:
MIS-F 400 x 400 mm (M6)

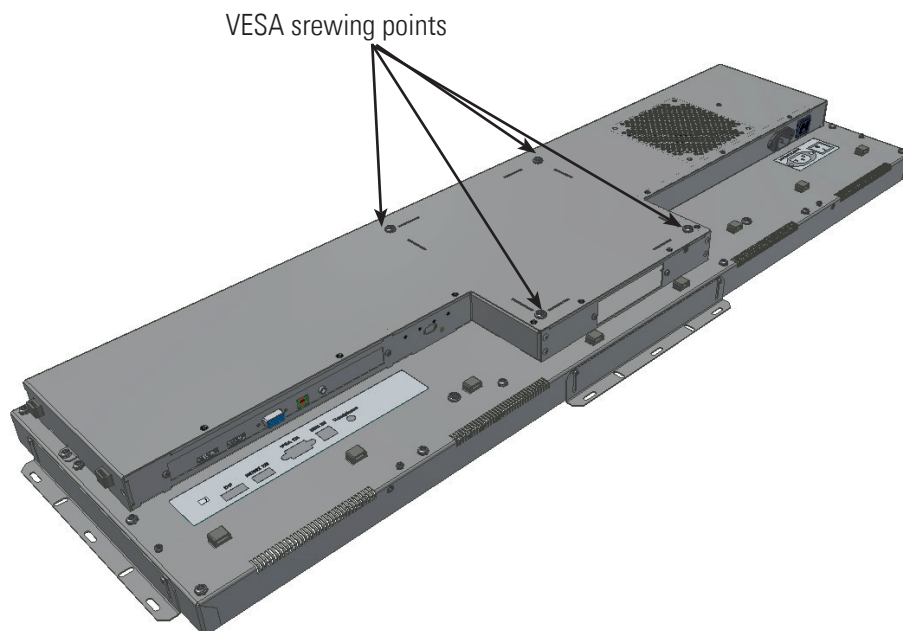

Allowed tilt angle for mounting



The monitors including the options offered by Distec may be mounted with a tilt angle of 0° to -30°.

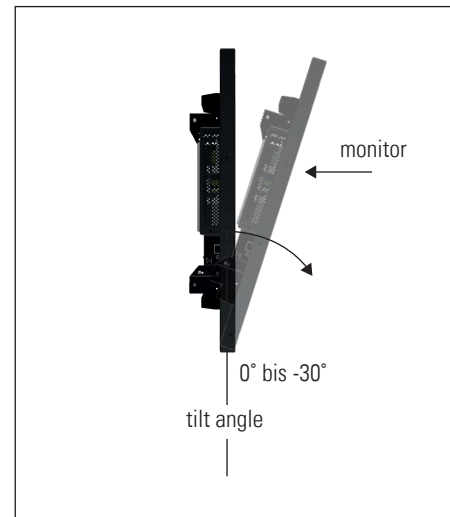

Connecting to power

XTRA-Line bartype displays require a voltage of 110V - 230V AC.



Note: Install all data cables to external devices before connecting the display to power.

- Switch the on/of switch in position off.
- Connect the power cable to the display.
- Connect the power cable to a power socket.
- Switch the display on .

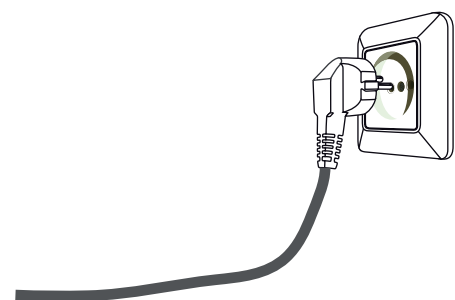
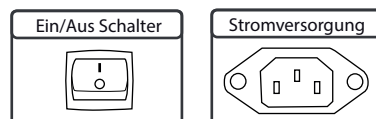
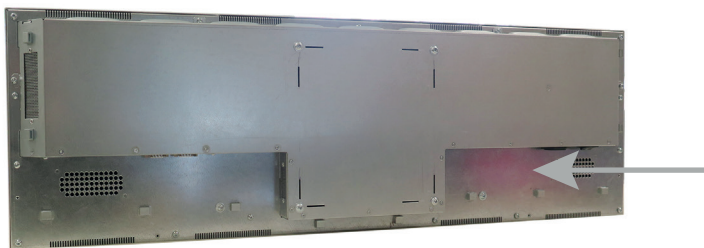

OSD navigation through IT Remonte Control

Alternative to the external OSD keypad, the Prisma-III A can also be controlled through a remote control device.



Key	HEX	Function		
		General	OSD Closed	OSD Open
Power	01	Power on/off	-	-
Number Keys	00-0E	Not used	-	-
Number „0“	13	Not used	-	-
ID	19	Not used	-	-
Recall/Return	10	Not used	-	-
Disp	1D	Not used	Display Mode	-
Mute	12	Not used	-	-
Input	18	-	Input Select	-
Menu	41	-	Opens OSD	Select
Exit	09	-	-	Exit /Back
Up	17	Not used	-	-
Left	0D	-	Volume -	-
OK	15	-	-	Select
Right	14	-	Volume +	-
Down	1A	Not used	-	-

OSD navigation through IT Remonte Control - second variant of remote control

Alternative to the external OSD keypad, the Prisma-III A can also be controlled through a remote control device.

Position	Code	Function
1	0x01	Power
2	0x0D	Key Up
3	0x11	Key Down
4	0x0E	Key Left / decrease Brightness
5	0x10	Key Right / increase Brightness
6	0x0F	Key Enter
7	0x27	Menu
8	0x13	Exit
9	0x05	Mute
10	0x04	Volume +
11	0x03	Volume -

RC-10-007 Button Position

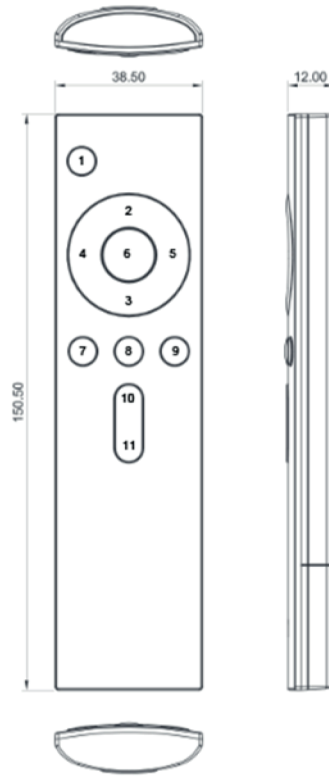

RC-10-007 Picture



5. Ambient Light Sensor

The scope of delivery includes the ambient light sensor and the ALS cable. In order to be able to use the Ambient Light Sensor, two work steps have to be carried out.

The first step is to connect the cable to the ambient light sensor. When installing the ALS cable, make sure that it is installed the right way round. Furthermore, the cable must first be threaded into the housing with the "noses", now press the connector down and clip it in. Here are two pictures for a better understanding.



In the second step, the cable must be connected to the monitor. The ALS cable is mounted on the monitor via a connection socket. Important, the plug only fits in one direction, please note.



If the monitor is switched on, the ALS function is active. The ambient light sensor is to be mounted using the screw connection point on the circuit board.

6. XTRA-Line Bartype 37 PME

Connectors and OSD buttons of XTRA-Line Bartype 37 Video PME series

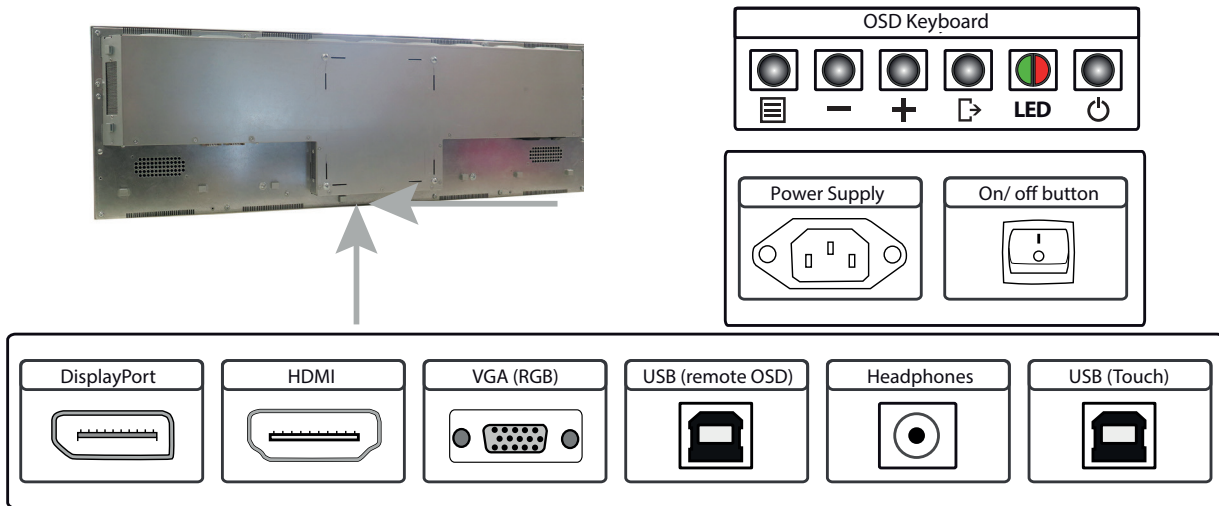

Connecting to a PC with VGA cable

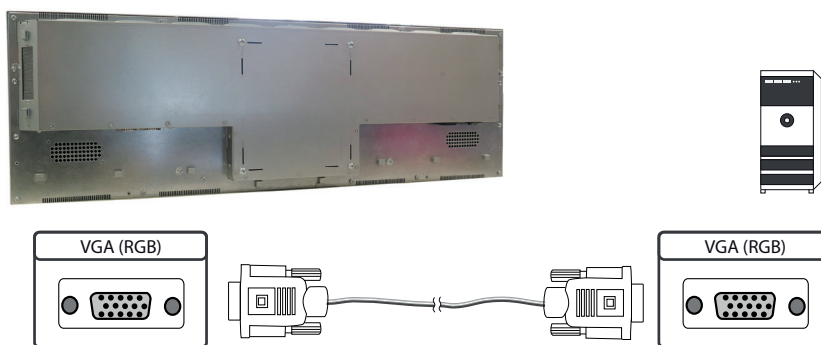

Connecting to a PC with HDMI-DVI cable

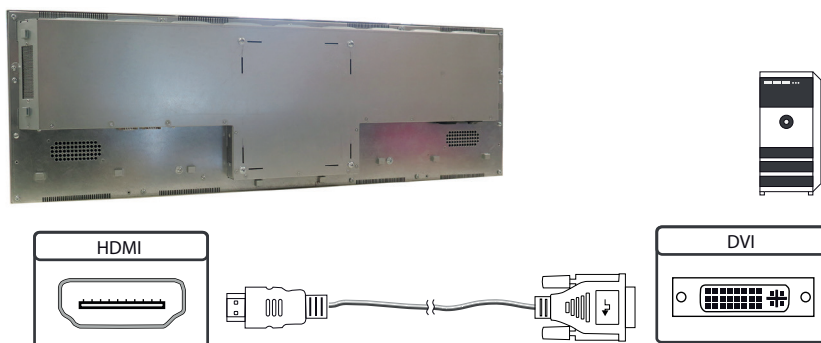

Connecting to a PC with HDMI cable

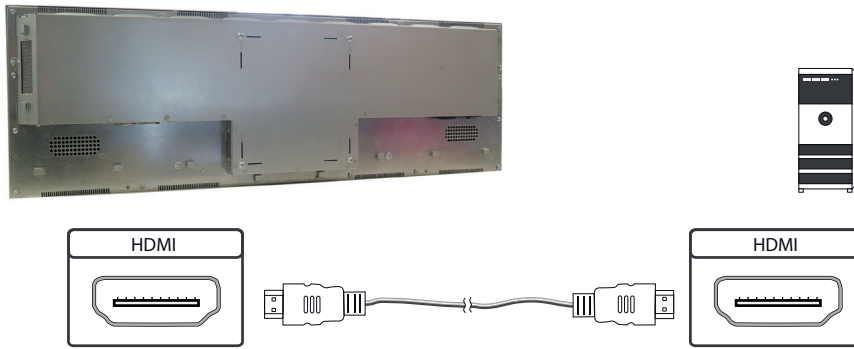

Connecting to a PC with DisplayPort cable

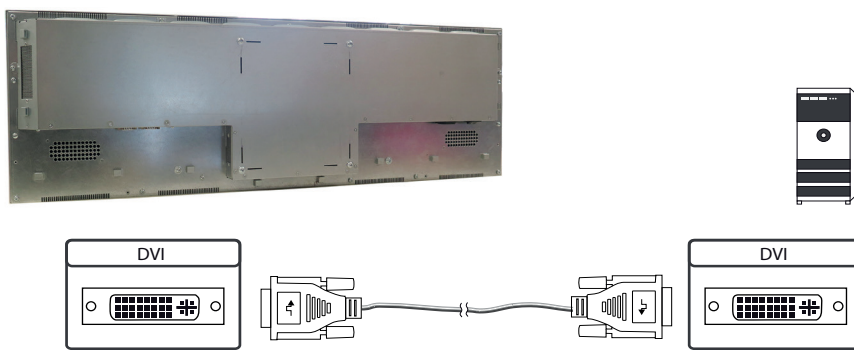

OSD keyboard

OSD functions of the monitor can be controlled via OSD key pad. The OSD allows selection of input source and fine tuning of various functional parameters like brightness, contrast etc.

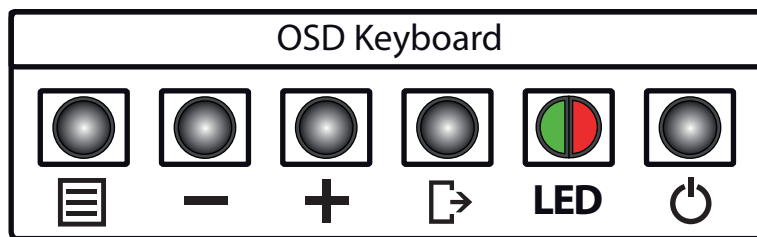

The OSD control can either be used:

- to access various functions directly
- to navigate within the OSD

The following two tables give an overview about the functions:

Direct functions:

Key	Function	Comment
Menu	Open the OSD menu	
—	Open volume control	
+	Open brightness control	
Exit	Select signal input	
Power	On/ Off	

Navigation in OSD menu:

Key	Function	Comment
Menu	Open sub menu	when in main
	Confirm entry	when in main
—	Cursor down	when in main or in sub menu
	Cursor/ slider to the left	when in main or in sub menu
+	Cursor up	when in main or in sub menu
	Cursor/ slider to the right	when in main or in sub menu
Exit	Leave OSD menu	when in main
	Leave sub menu	when in sub menu

The green/red LEDs (single package) on the external keypad show the current status of the board:

Color	Meaning	Remark
Green	Signal found	
Green blink	Search signal	
Red	Power safe mode	
LED off	Monitor off	

OSD menu

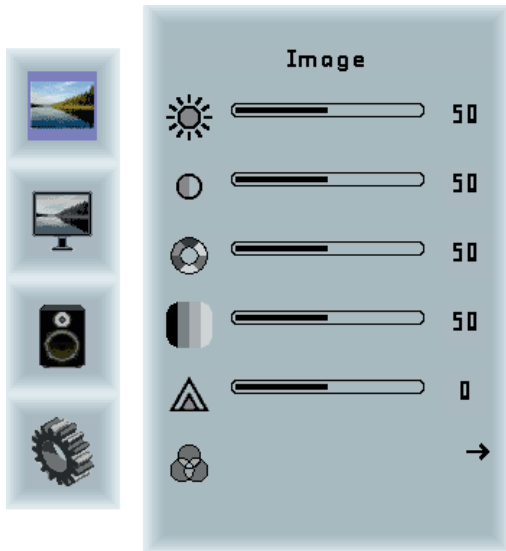

Image Menu

- Brightness: Panel brightness adjustment.
- Contrast: Panel contrast adjustment.
- Hue: Panel hue adjustment.
- Saturation: Panel saturation adjustment.
- Sharpness: Panel sharpness adjustment.
- Color: Opens the color sub menu.



Color Sub Menu

- Auto: Performs auto color adjustment.
- Color Temp: Allow selection of different color temperature schemes, predefined and custom. Available if color space of input is RGB.
- Full color: Selects full received color space.
- SRGB: Selects SRGB color space.
- XVYCC: Selects XVYCC color space.

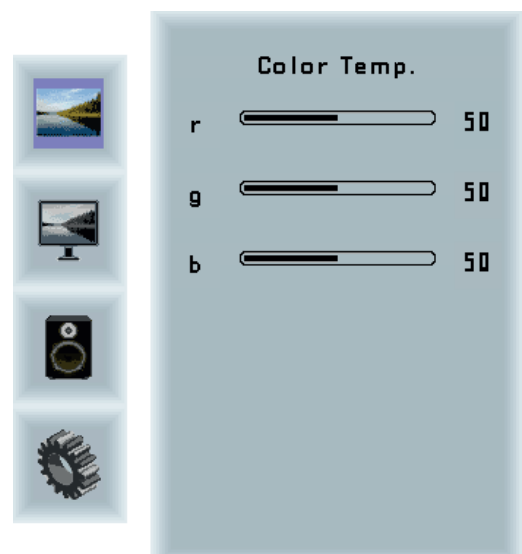

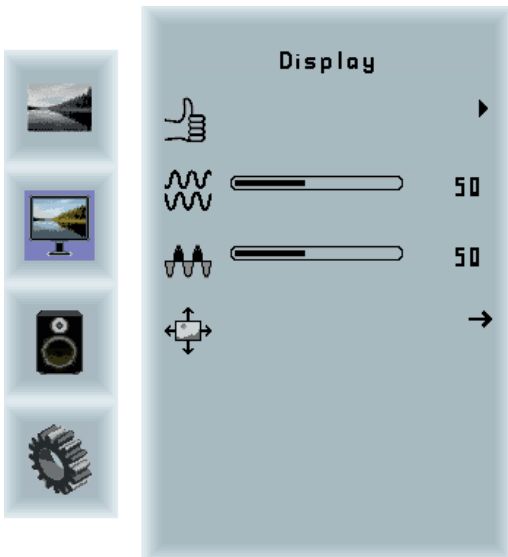

Display Menu

- Auto-adjust: Performs auto-adjustment on the VGA input image.
- Phase: This function is a slider to adjust the sampling phase of the analogue interface. For optimum image quality, input pixels should be sampled at the ideal sampling points.
- Clock: This function is a slider to adjust the sample clock of the analogue interface. This is helpful for improving the image quality for non-standard display modes.
- Position: Used to alter placement of the image.

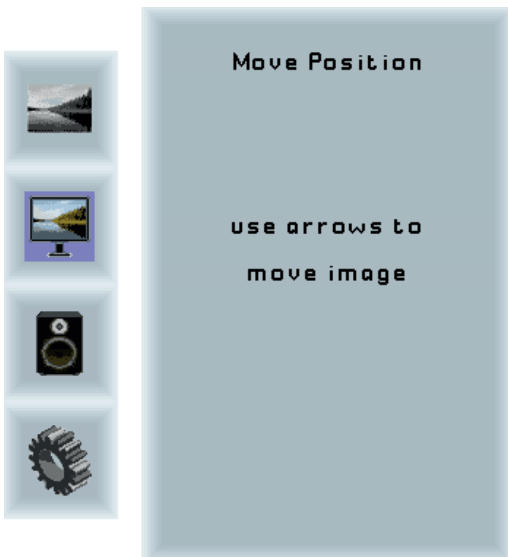

Move Position Sub Menu

- Arrows: Use arrow keys to move the position of the image on the screen.

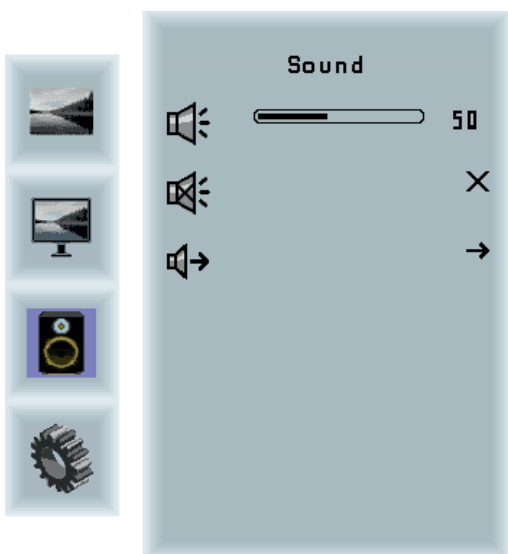

Sound Menu

- Volume: Slider bar to adjust volume.
- Mute: Mutes audio.
- Output: Chooses between speakers and headphone. Only one can be active at a time (Speakers are not available for XTRA-Line monitors).

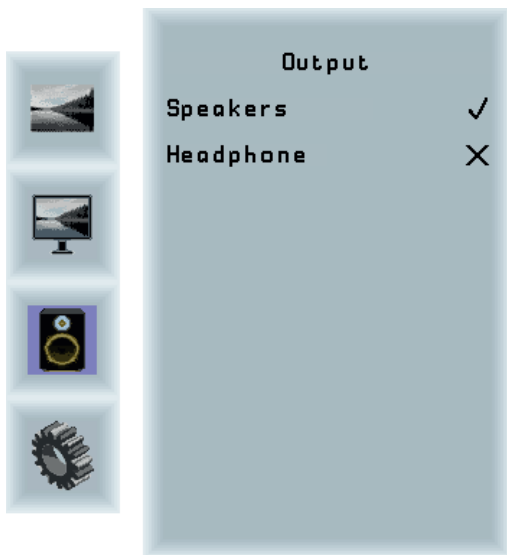

Output Sub Menu

Speakers: Toggles speakers on/ off.
 Headphone: Toggles headphone on/ off.



System Menu

Input source: Sub menu to select input source.
 OSD settings: Sub menu for OSD settings.
 Factory reset: Sub menu for Factory Reset.
 EDID settings: Sub menu for EDID settings.
 FW Revision: Firmware revision.
 OSD Revision: OSD revision.

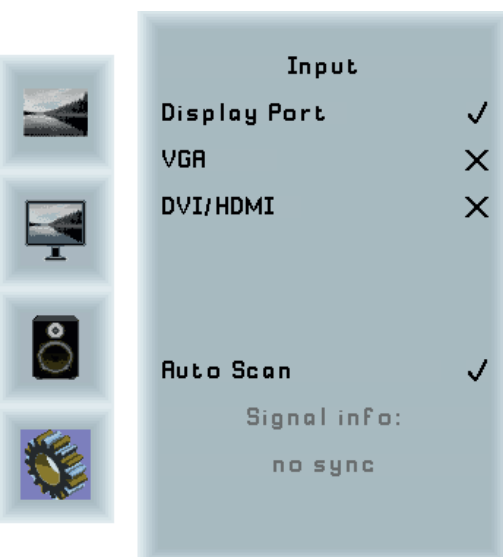

Input Sub Menu

Display Port: Select display port as input signal.
 VGA: Select VGA as input signal.
 DVI/HDMI: Select DVI/ HDMI as input signal.
 Auto Scan: Enable/ disable input auto-scan.



OSD Settings Sub Menu

- Timer: Sub menu for timer settings.
- Rotation: Sub menu for rotation settings.
- Position: Sub menu for image position.
- Transparency: Slider to set transparency.

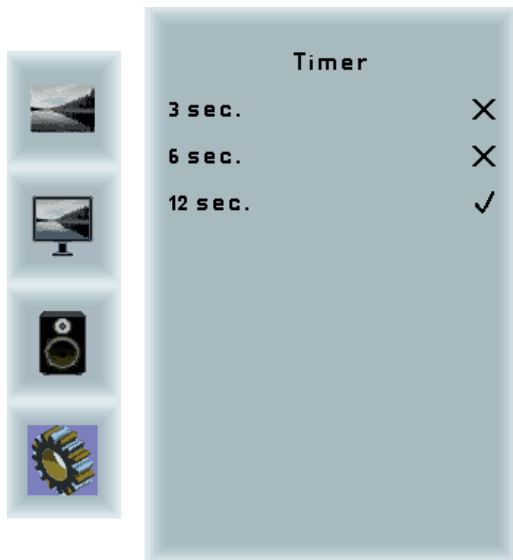

Timer Sub Menu

- Timer: Selects how many seconds the OSD will remain active after the last use.

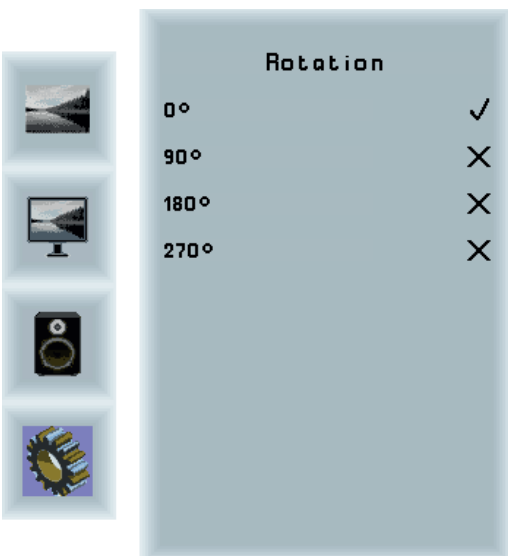

Rotation Sub Menu

- Rotation: Rotates the OSD menu.

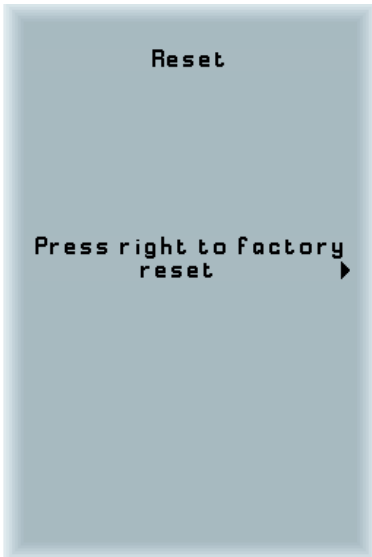

Reset Sub Menu

Reset: Performs factory reset.

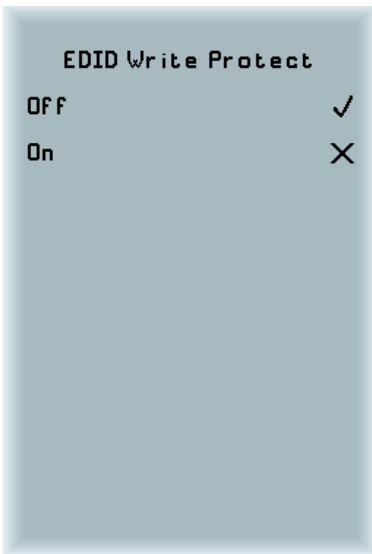

EDID Write Protect Sub Menu

Write protect: EDID write protect on/ off.

7. XTRA-Line Bartype 37 IoT

The XTRA-Line Bartype 37 IoT monitor is equipped with the Raspberry® Pi compute module 3+ (CM3+). The specification can be found under the following link:

<https://www.raspberrypi.org/products/compute-module-3-plus/>



Note:

The full driver package for the IoT monitor can be found on our website: <https://www.distec.de/en/service/downloads/artista-iot-downloads/>.

The device is equipped with a battery. Please note the following:

- Disconnect the device from the power supply before replacing the battery.
- If the battery is not replaced properly there is a risk of explosion.
- Always replace the battery with another one of the same type.
- Supply empty batteries to the local waste battery return system. Please also observe the notes in chapter „Disposal“.

Passive cooling

Monitors of the XTRA-Line Bartype 37 IoT series are equipped with a passive cooling system. Passively cooled monitors divert the heat of the processor to the monitor's housing. Passively cooled devices have no moving parts.

Spezification

Please refer to the current data sheet for the details of the IoT monitor specification.

Connectors of XTRA-Line Bartype 37 IoT series

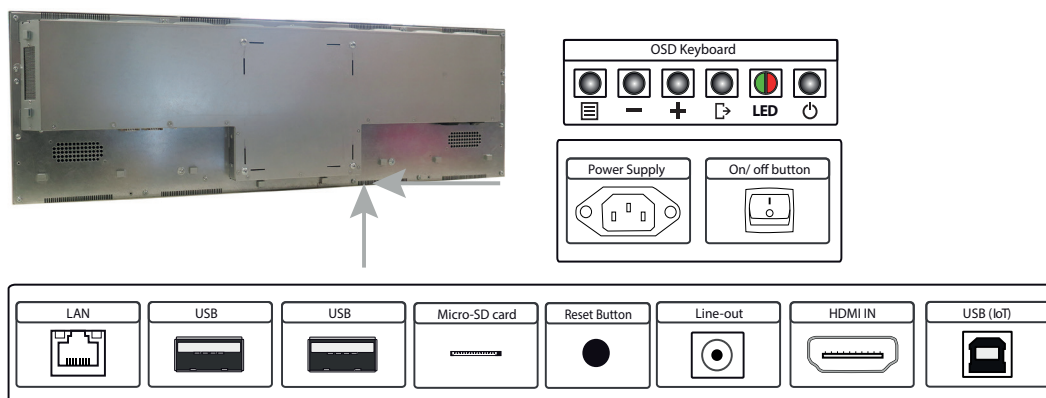

Connecting to a network using a patch cable

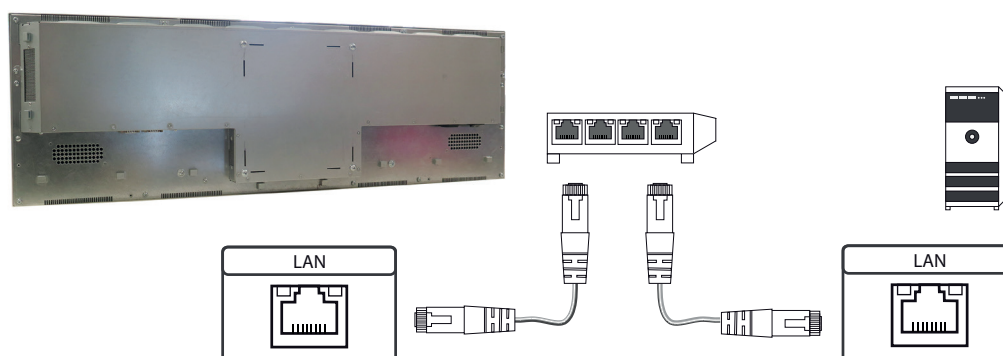

Connecting to a PC using a cross-over cable

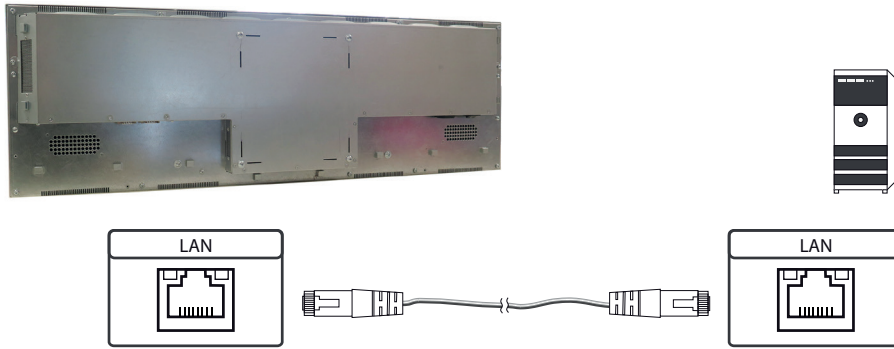

Connecting to an USB stick or keyboard/ mouse

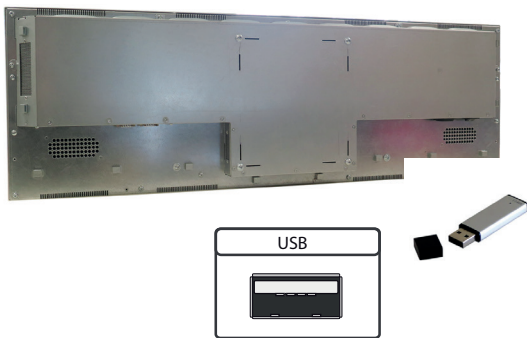

Connecting active speakers

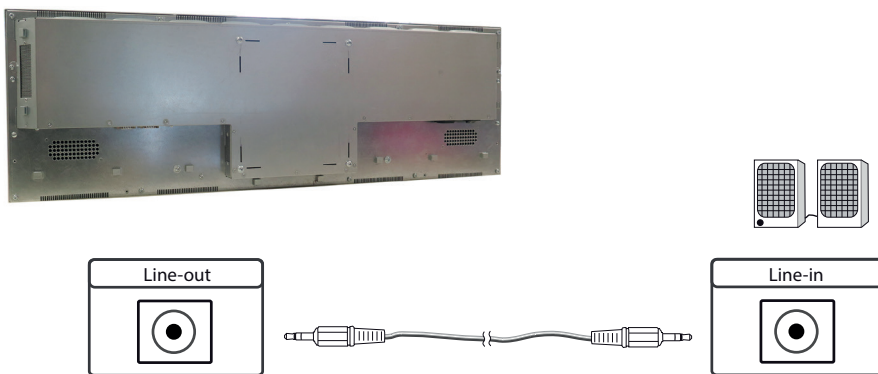

Connecting a signal source using a HDMI cable

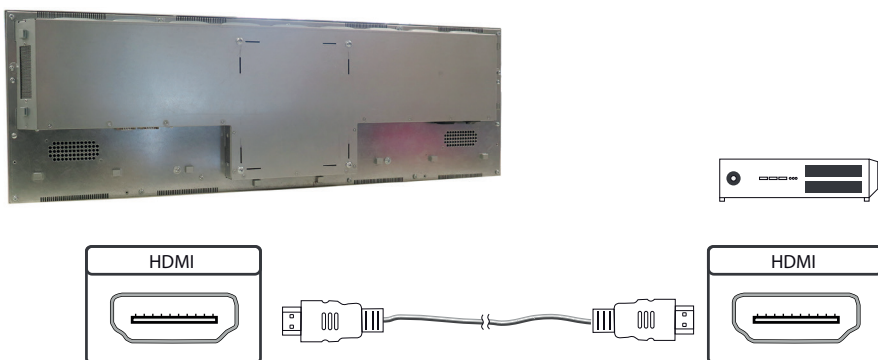

Connecting a signal source using a HDMI-DVI cable

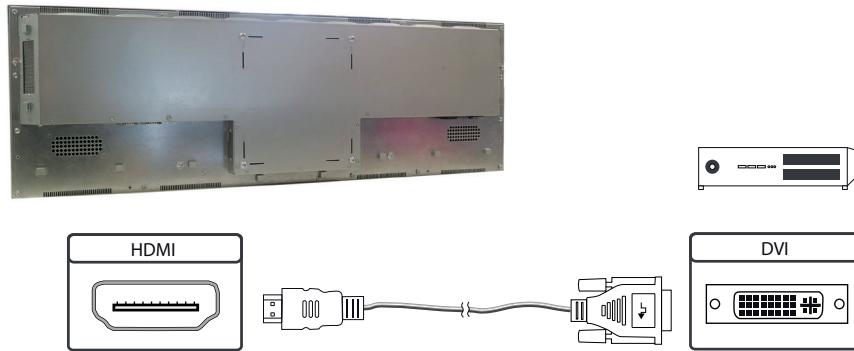

Switch on/ off

After the supply voltage has been applied, the IoT monitor starts automatically. To switch off, you must select „Shut down“ in the operating system.

Operating systems

The IoT Monitor comes with the operating system Raspbian, which is equipped with all necessary drivers. This operating system is the official version of the community, reduced to the internal memory of the compute module. It is only used for the first commissioning of the monitors.

The IoT Monitor can be equipped and programmed by the customer with its own operating system/ image. For this, the USB port on the back of the monitor in the connection cover can be used, which is located under the OSD menu.

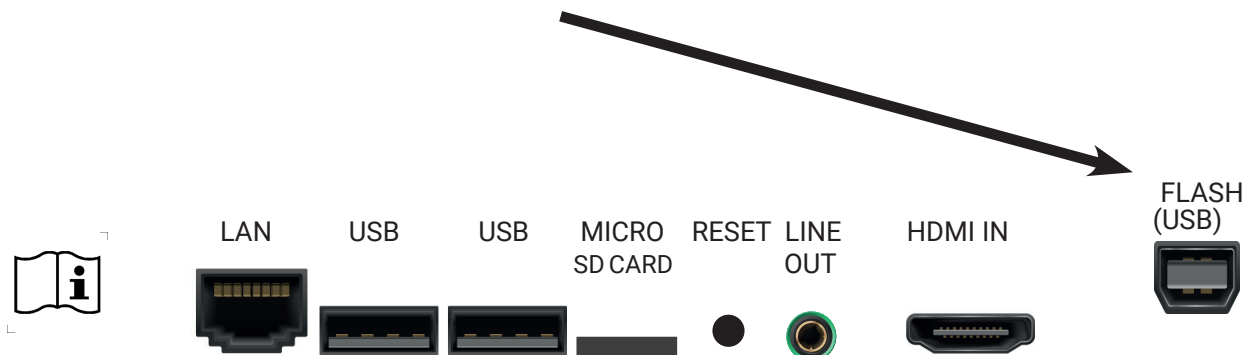

A guide for the integration of an image can be found on the enclosed DVD or on our homepage:

<https://www.distec.de/en/products/tft-controller/iot-industry-40-raspberry/>

In the community of Raspberry® Pi (<https://www.raspberrypi.org/forums/>) you can find many problem-solving and help to integrate and create your own system.

8. Maintenance

Systems with active cooling require cleaning of ventilation slots every 6 months. Systems with passive cooling must be cleaned every 12 months.

9. Guarantee / Service

Guarantee

Distec GmbH grants a manufacturer's guarantee of two years from the date of delivery.

The performance of guarantee claims shall cause neither an extension nor a restart of the guarantee period.

During the guarantee period, Distec shall correct product faults based on material or production defects. The guarantee service is executed at Distec's discretion through repair, replacement of defective parts or by exchanging a product for a product of equal quality without charging the customer for material or labor.

Guarantee claims are only accepted, if Distec receives notification of a defective product within the guarantee period and the product is presented to the Distec Service Centre together with all information as specified in the RMA process.

Guarantee Exclusions and Limitations

This guarantee does not apply to any defect for which Distec is not responsible and which include but are not limited to the following:

- Unauthorized opening or disassembling of the product
- Faulty maintenance by non-observation of maintenance instructions
- Inappropriate storage or cleaning of the product
- Unauthorized modification of the product
- Incorrect use or misuse
- Non-observation of operating and installation instructions
- Permanent display of fixed images (causing image retention or image sticking)
- Operating the product in conditions which exceed the limitations of the specification
- Use of inappropriate boxes, packaging or modes of shipment
- Force majeure like fire, acts of war, acts of violence, chemical or biological impacts, lightning strikes, over voltage or similar events
- Fault resulting from the use of software which was not originally supplied with the product or which is incorrectly installed
- Normal wear and tear and wearing parts (i.e. LCD panel)

Mechanical damage like scratches, pressure or break points are excluded from this guarantee.

This guarantee does not include accessory parts which are not integral part of the product like boxes, batteries).

Pixel errors only constitute a fault under the terms of this guarantee if they deviate from the product specification (i.e. ISO 9241-307 pixel failure class II).

Display Quality - Prevention of after image burn in effects

After image burn-in means that an image or part of an image (i.e. logo) remains visible on the screen even if the image on the screen is changed. This should not occur if the LCD panel is operated in normal conditions with changing content. To prevent burn-in effects please follow the following guidelines.

- Don't display fixed patterns for an extended time period of more than 12 hours.
- Power-off the monitor for 4 hours after using it for 20 hours, and for 2 hours after using it for 12 hours.
- Use the power scheme and power management of the PC.
- Use plain-colored screen savers.
- Avoid patterns with a strong difference in brightness and contrast.
- Avoid gray colors.
- Change images and logos regularly. Show animated pictures for 60 seconds after 4 hours of operation.
- The best way to protect your display is to switch the monitor off when not in use or to use screen savers.

Non-observance of these guidelines may have effects on warranty.

Guarantee Processing

Group RMA process. In order to avoid unnecessary charges, it is important to adhere to the RMA regulations.

Products must be packed appropriate and professional for a safe return to the Distec Service Centre. Products with panel sizes equal or larger 81 cm (32") must be shipped on pallets in upright position.

Distec does not assume liability for any customer data stored on products which are returned to Distec.

Limitations of Liability and Benefits

With this guarantee declaration, Distec exclusively guarantees that the product is free of material and manufacturing faults.

Distec does not issue any other guarantee or similar statements other than this declaration.

This guarantee does not impair or affect a buyer's statutory claims against the seller due to material damage. Such claims can be asserted instead of guarantees agreed to here at the buyer's discretion.

Mandatory legal rights and mandatory claims under the German Product liability remain unaffected.

Applicable Law and Place of Jurisdiction

The laws of the Federal Republic of Germany apply.

Place of jurisdiction is Munich.

Service addresses

Germany

Distec GmbH
 Augsburg Str. 2b
 82110 Germering
 ☎ +49 89 89 43 63 0
 ✉ support@distec.de

Great Britain

Display Technology Ltd.
 Osprey House, 1 Osprey Court
 Hichingbrooke Business Park
 Huntingdon, Cambridgeshire, PE29 6FN
 Tel. +44 14 80 41 16 00
 Mail info@displaytechnology.co.uk

USA

Apollo Corp.
 87 Raynor Avenue, Unit 1
 Ronkonkoma NY 11779
 ☎ +1 631 580-4360
 ✉ info@apolloedisplays.com

Please go to the following web address for further information about our RMA regulations and RMA forms:

<https://www.distec.de/en/service/return-rma/>

10. Disposal

Disposal of old devices

If the acquired Distec product is to be disposed of, must be implemented into national law the Directive "2012/19 / EU".

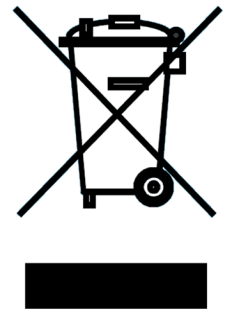

Disposal of batteries

Applicable in all countries of the EU and in countries with separate battery collection systems.

The Batteries in this product should not be disposed with other household waste. The chemical symbol Pb, CD or Hg indicate that the battery contains lead, cadmium or mercury above the reference level in EC directive 2006/66.

Batteries which are not disposed correctly can cause harm environment and health.

Our environment is close to our hearts. Please help us to protect our environment and recycle empty batteries with the free battery collection system.

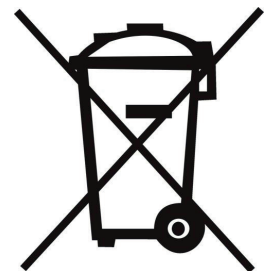

11. Declaration of Conformity

Declaration

Hereby the Distec GmbH declared that the unit EU is in compliance with the essential requirements and other relevant provisions of Directives 2014/30/EU and 2014/35/EU and 2011/65/EU.

If a CE declaration of conformity is required, please request it from support on our website: <https://www.distec.de/en/service/technical-support/>



Warning:

- This is a class A facility.
- This device can cause radio interference in living areas.
- In this case, the operator can be required to take appropriate measures.

FCC Declaration of conformity

This equipment has been tested and found to comply with the limits for a Class A digital device, pursuant to Part 15 of the FCC Rules. These limits are designed to provide reasonable protection against harmful interference when the equipment is operated in a commercial environment. This equipment generates, uses and can radiate radio frequency energy and, if not installed and used in accordance with the instruction manual, may cause harmful interference to radio communications. Operation of this equipment in a residential area is likely to cause harmful interference in which case the user will be required to correct the interference at his own expense.

Canadian Department of Communications Compliance Statement

This Class A digital apparatus meets all requirements of the Canadian Interference-Causing Equipment Regulations.

Observation des normes-Class A - Cet appareil numérique de la classe B est conforme à la norme NMB-003 du Canada.

FCC Information:

- Changes or modifications not expressly approved by Distec GmbH could void the user's authority to operate the equipment.
- Use the attached specified cables with the POS-Line monitor so as not to interfere with radio and television reception.
- Please use the supplied power cord or equivalent to ensure FCC compliance.
- Please use the supplied shielded video signal cable (PME), Mini D-SUB 15 pin to Mini D-SUB.