

# User Manual

## SL-Line Series

---



SL-Line monitors for 48.3 cm (19")  
and 58.4 cm (23")



## Copyright

The contents of this manual are subject to change without notice.

© 2017 Data Display Group. All rights reserved.

Reproduction of this manual in parts or entirely without the previous authorization of Data Display Group is prohibited.

Data Display Group is not liable for errors and collateral or subsequent damage which result from supply, deployment or any other utilisation of this document.

All product names mentioned in this document are trademarks or registered trademarks of their due owners.

## Table of Contents

1. General Specifications .....	4
2. Chassis Versions.....	4
3. Scope of Delivery .....	5
4. General Safety Regulations .....	6
5. First Installation.....	9
6. Touch Sensors.....	12
7. SL-Line Video PIII.....	13
8. Maintenance .....	22
9. Guarantee / Service .....	22
10. Disposal .....	24
11. Declaration of Conformity .....	24

## 1. General Specifications

---

### Scope of Document

This user manual is valid for POS-Line monitors up to 68 cm (27"). The POS-Line monitors are offered in different screen sizes and with various controllers and other options.

**Important note:** This user manual is complemented by other additional documents when indicated.

All documents are also available for download from Data Display Group web site: [www.datadisplay-group.com](http://www.datadisplay-group.com).

### SL-Line monitor versions:

SL-Line Video PIII: Monitor with integrated AD converter board, 1 x RGB, 1 x DVI, S-Video, Composite Video

## 2. Chassis Versions

---

For SL-line monitors are available as version with additional USB ports. This implies a deviation in the housing form. Options such as glass or touch screen does not change the external appearance.

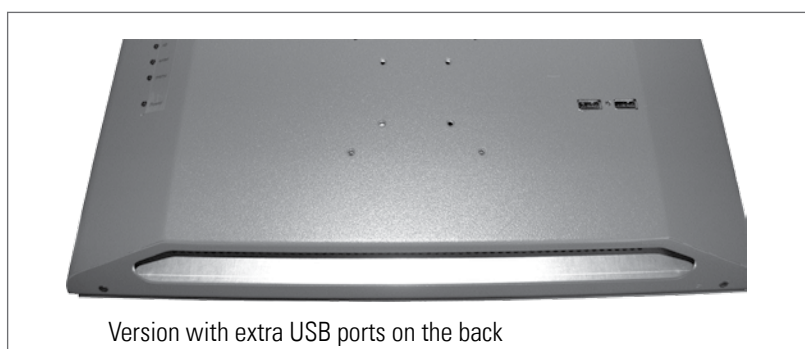

### 3. Scope of Delivery

---

When unpacking the monitor, please check if the following accessories are included in the shipment:



Note: Pictures can differ from actually supplied products.



User manual



Accompanying-CD (Manuals, Datasheets, Driver, Drawings)



Power supply



RGB cable



USB cable\*



Power cable\*\*

\* Devices with touch sensor only

\*\* Cable may vary depending on country

# 4. General Safety Regulations

---

## Safety information

Please read this safety information carefully for your personal safety and for the prevention of property damage.

In case of a malfunction, immediately disconnect the power plug and contact your dealer or the next Data Display Group service centre. A malfunction is also considered if the housing, a control element or cable is damaged or if liquids or other objects penetrate the monitor.

Please read the safety information carefully before installing the device. If you have any doubts about whether the device may be used in a particular environment, please contact our service partner.

## Repairs

Repairs may only be carried out by authorized technical personnel. Unauthorized access or improper repairs might cause serious property damage or cause danger to the user. In addition to that, any legitimate warranty claim expires.

## Electrical connection

Disconnect the monitor from socket before executing any work. Do not touch or connect data cables or power cables during thunderstorms.

## System start-up

Before the system start-up let the monitor adjust to the room temperature. Do not expose the device to direct heat sources. In case of condensation, please wait a minimum of 12 hours before switching on the monitor. The monitor shall only be installed and used according to this documentation data sheets. Only qualified personnel may perform the initial installation and system setup.

## Qualified personnel

Qualified personnel, in terms of the safety information of this documentation, are persons who are qualified to activate, ground and label devices, systems and circuits according to the safety standards.

## Operation

For a proper and safe utilization of the product, adequate transportation, storage, installation, assembly, careful handling and maintenance are essential. The device is only certified for in-door operation. Extreme ambient conditions shall be avoided and the monitor shall be protected from dust, humidity and heat. Do not expose the monitor to direct sunlight.

## Transport

Unpack the monitor at the place of installation. Use only original packaging for transportation. Please observe these rules for any later transport.

## Condensation

Avoid condensation during transport at low temperatures or at extreme fluctuations of temperature.



### Safety guidelines for the handling of LCD monitors

- If the device is not used for a long period of time, unplug the power cable.
- Do not unplug the power cable while the device is powered on, except for emergencies.
- To unplug the device without problems, sockets have to be easily accessible.
- Ensure that the power cable does not get pinched or kinked.
- Do not place heavy objects on the power cable.

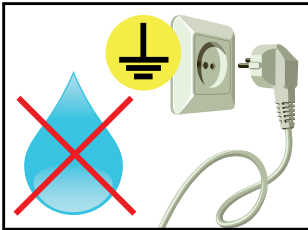

- Do not use damaged or loose sockets to plug in the device.
- Plug the device in earthed sockets only.
- Operate the device with the power cables included in the delivery packet only.
- Use undamaged power cables only.
- When plugging in and out, do not touch the power cable with wet hands.
- Ensure that the power cable is plugged in the socket safely and correctly.
- Use for devices with external power supply only the supplied original power supply, or an equivalent Low Power Source (LPS).

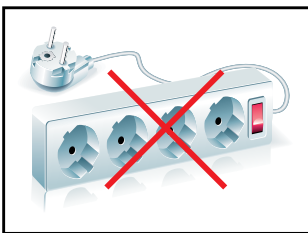

- Do not use extension block to plug several devices into a single socket.



- According to the size, devices may be difficult to handle and very heavy. Ensure that at least two people lift and carry the device.
- Put down the device slowly and carefully to avoid damaging the LCD screen. Ensure that the device stands stable.
- Keep packaging away from children. Danger of suffocation!
- Use our specified and professionally mounted wall mounting only.



- Do not put objects onto the device.
- Do not place candles, heaters or humidifier near the device.
- Keep the device away from fireplaces and flammable materials.

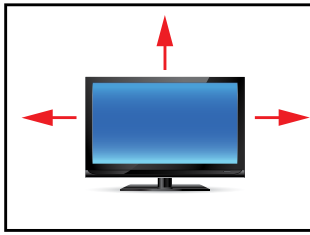

- Ensure sufficient ventilation of the device.
- Keep a minimum distance of at least 10 mm devices to the wall, for devices with integrated PC of at least 40 mm.
- Ensure compliance with the operating temperature.

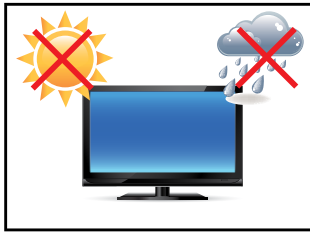

- Do not install the device in places where it is exposed to environmental impacts such as rain or direct sunlight.
- Do not install the device in places where it is exposed to high humidity, dust or smoke. In case of doubt, please contact your sales partner.



- Please use a soft, moist cloth for cleaning.
- For cleaning the screen, please use only commercially available screen cleaner. Do not spray the cleaner directly to the device but onto a cloth.
- Please clean ventilation slots regularly to ensure a good air circulation.

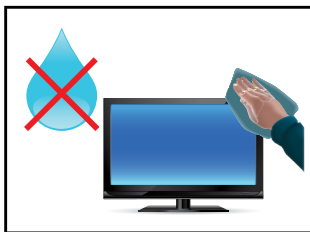

- Protect your device from water splash.
- When cleaning, please make sure that no liquids get into the device.
- Screens and surfaces can be easily scratched. Therefore, please use the prescribed cloth only.



- Caution high voltage! Never open the device by yourself.
- In case of unusual noises, burnt smell or smoke unplug the power cable.
- Do not insert objects into the device through the ventilation slots.
- If the same picture is displayed over a longer period of time, an after-image may arise.
- When exchanging batteries, pay attention to the polarity. Keep batteries away from children and ensure an environmentally correct disposal.



## 5. First Installation

---

### Position of connectors and controls

All the connectors for power and cables are located at the bottom of the back side of the display. The OSD keyboard is located left on the back side (back view).

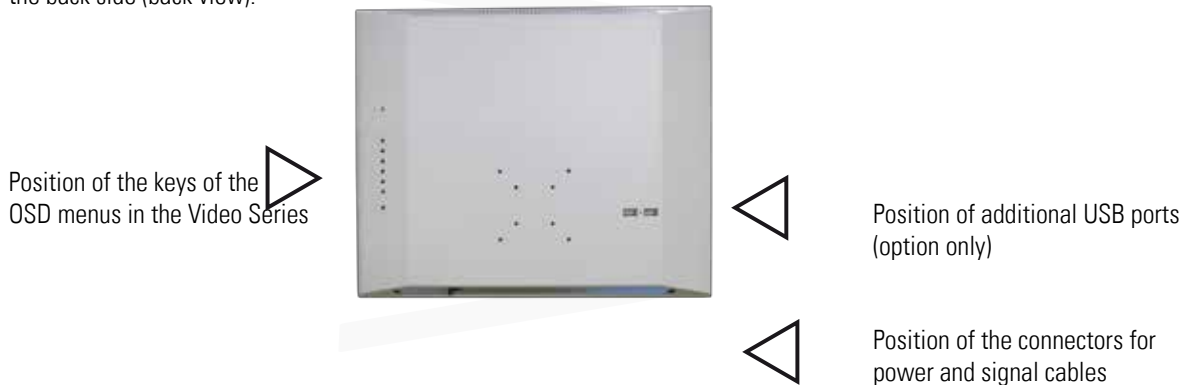

### Additional USB ports

The 4-port USB2.0 hub complies with Universal Serial Bus Specification Revision 2.0. Three ports are available for this hub.

- If this device is connected to a USB1.1 host / hub using a USB-B to USB-A cable, it works like a USB1.1 hub.
- When connected to a USB2.0 host / hub, it works as a USB2.0 hub.

The maximum data transfer rate is 480Mbps when connected to a USB2.0 host / hub. Each port has 500mA supply current at 5V. The integrated overcurrent protection device switches off a faulty port as required. Disconnect the monitor from the power supply, remove the faulty USB device. The monitor can be reconnected then to the power supply.

### Mounting with VESA compliant monitor brackets

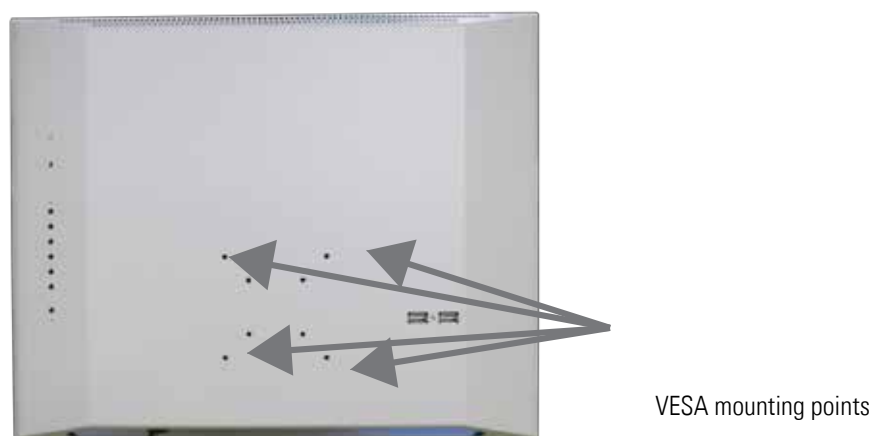

The SL-line monitors have an integrated VESA mounting.

The operating position of the device is perpendicular (90 degrees to the floor). For wall mounting, the permissible tilt angle is observed. The device can be operated both in landscape mode and in portrait mode.

VESA formats:

19" VESA 40 x 40/75 x 75

23" VESA 40 x 40/75 x 75/200 x 200

## Allowed tilt angle for mounting

SL-line monitors can be mounted with the adjacent tilt angles..

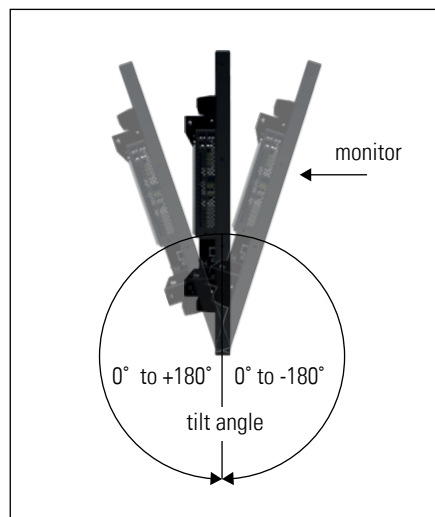

## Connecting to Power



Note: All the POS-Line monitors requiring 12V DC power are shipped with an appropriate power supply.

Display	Input voltage	Output voltage	Output current	Power
Power supply for SL-Line series	100-240 V AC	12V DC	5 A	60 Watts

## Connecting to power with included power supply



Note: Connect the data cables to external devices before plugging the display to the power.

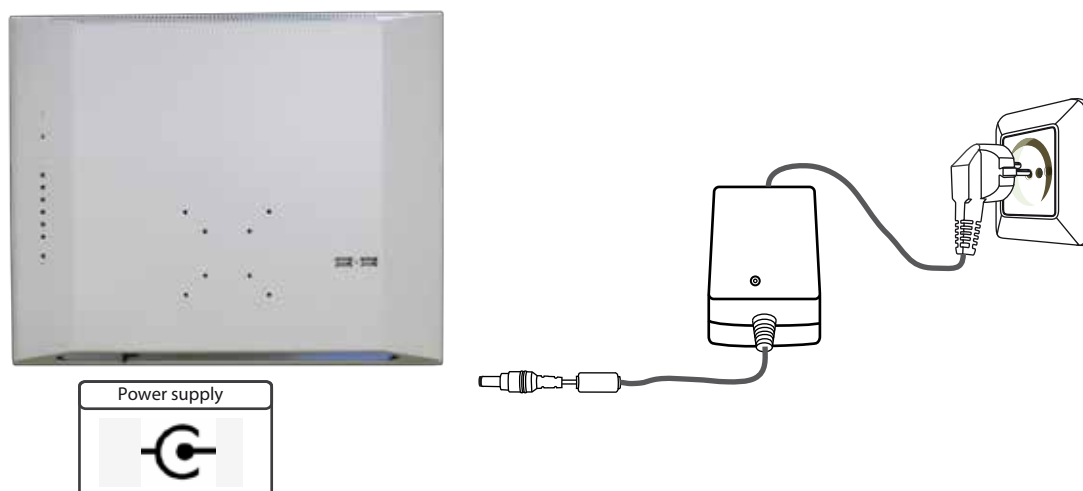

All monitors with power supply have an adapter cable to connect the AC adapter. This cable is included in the scope of delivery.

- Connect the adapter cable of the 12V power supply to the monitor.
- Insert the power cable into the power supply.
- Connect the power cable to a power socket.

### Connecting to an existing power supply



Caution: If SL-Line monitors, which require 12V DC as input voltage, are supplied with their own or customer-specific current source, a protection class I power supply must be used.



Caution: The power source for POS-Line monitors with 12V DC operating power must not exceed the limit of 250 VA.

- Make sure that your external power supply is sufficient for the display. The maximum power consumption of the display is indicated in the data sheet and the display label.

## 6. Touch Sensors

SL-Line monitors are available with touch option. Depending on the panel size, different touch systems and touch technologies are used. If the monitor has been ordered with touch option, the touch sensor and touch controller are installed at factory.

### SL-Line Video:

The drivers for these monitors must be installed on your PC system. HID devices do not need drivers for Windows 7 and 8. Please contact our support center if you are using LINUX based computers.

If a driver is required, the touch on this driver must be calibrated. Is it a HID Touch, Windows calibration in the control panel must be performed.



path:

Control Panel \ All Control Panel Items \ Tablet PC Settings

**Note:** All drivers for the touch sensors can be found on the enclosed CD. The following table gives an overview over the touch systems including web addresses for driver downloads.

Touch system overview:

Panel size	Touch technology	Manufacturer	Type	Driver download
19"	4-wire resistive	DMC	190A140A	<a href="http://www.datadisplay-group.de/service/downloads/touch-treiber/#c9816">http://www.datadisplay-group.de/service/downloads/touch-treiber/#c9816</a> WIN 10 — DMT-DD1.14 WIN 7/ XP — TSC-DD 1.00.33
23"	AMR	eTurbo	SR-30M182235D6	HID device, no driver required for Windows

## 7. SL-Line Video PIII

### Connectors and OSD buttons of SL-Line Video PIII series

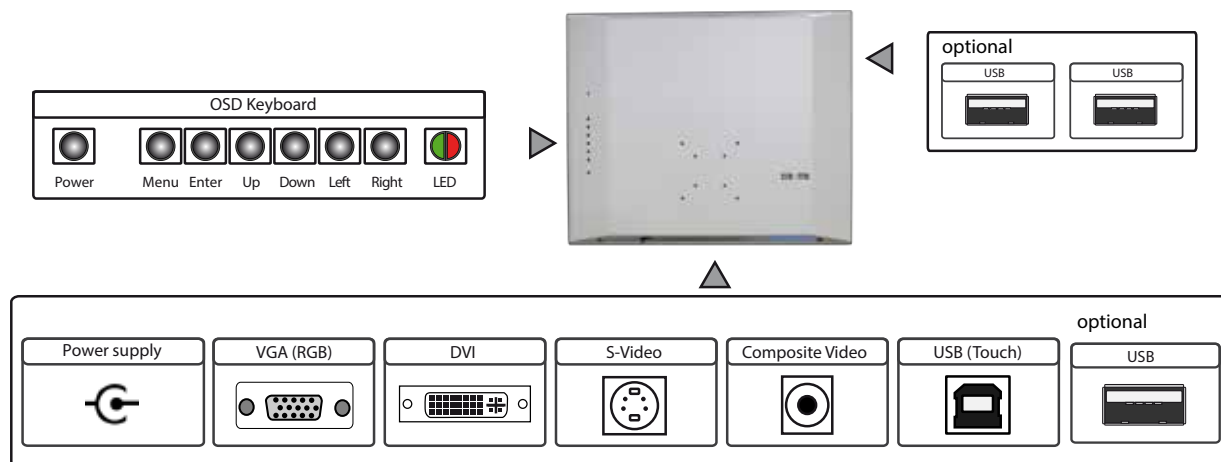

### Connecting to a PC with VGA cable

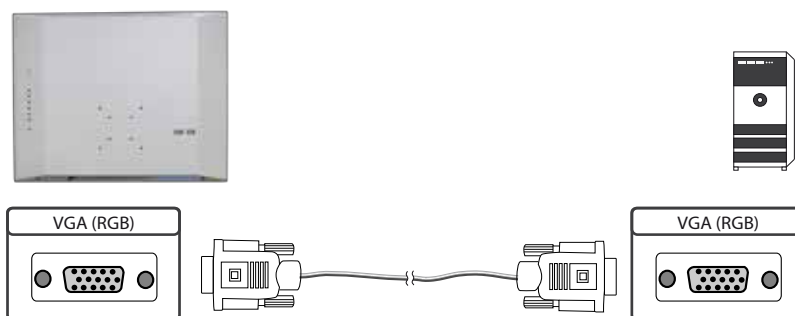

### Connecting to a PC with DVI cable

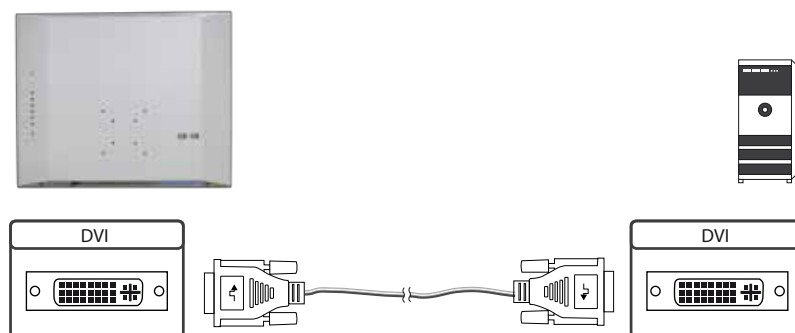

### Connecting to a PC with DVI-HDMI cable

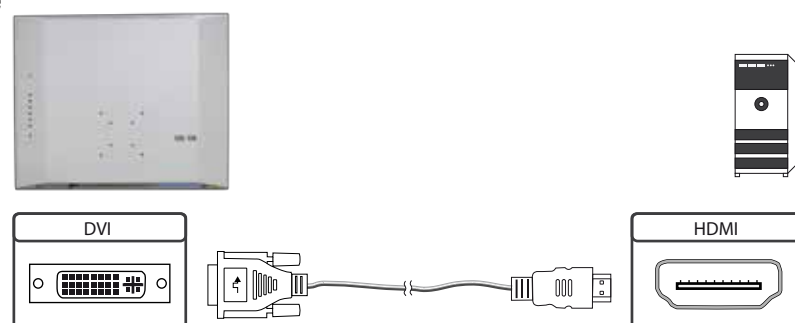

Connecting to an external device with S-Video cable

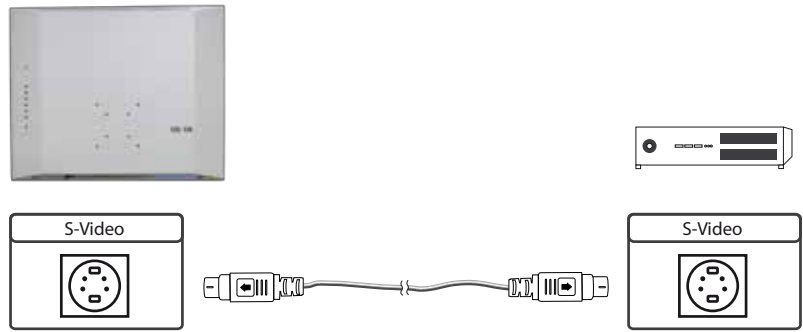

Connecting to an external device with Composite Video cable

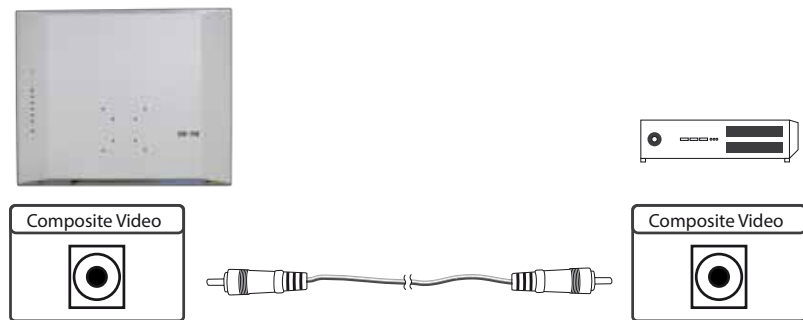

Connecting the Touch to a PC with USB cable (for displays with touch sensor only)

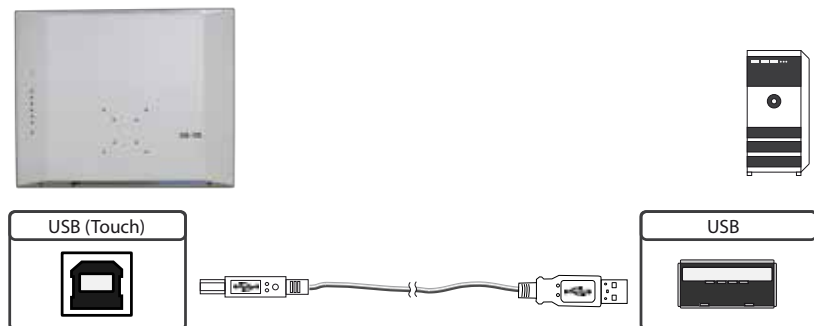

Connecting USB cable (option) to a PC or different devices with USB cable

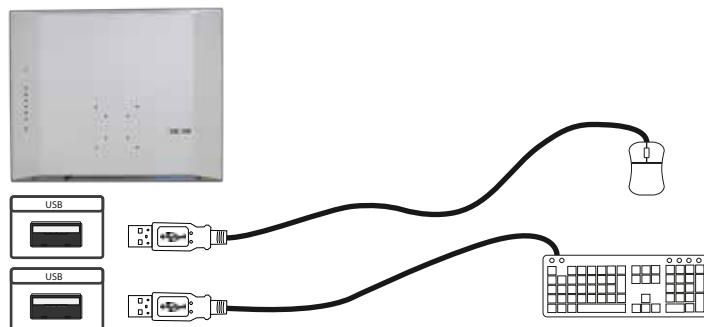

## OSD keyboard

The OSD functions of the monitor can be controlled via OSD key pad. The OSD allows the selection of the input source and the fine tuning of various functional parameters like brightness, contrast etc.

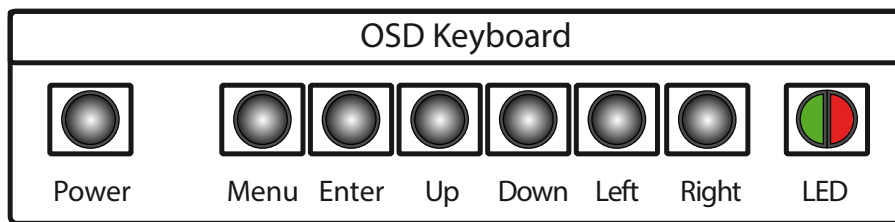

The six buttons of the OSD control can either be used:

- To access various functions directly
- To navigate within the OSD

The following two tables provide an overview of the functions:

Direct functions:

Key	Function	Remark
Power	On/ Off	
Menu	Open the OSD menu	
Enter	Confirm entry	
Up	Select signal input	
Down	Select PIP menu	if PIP/ PAP is activated, otherwise without function
Left	Without function	
Right	Without function	

Navigation in OSD menu:

Key	Function	Remark
Menu	Close OSD menu	when in main
	leave sub menu	when in sub menu
	leave function	if function is selected
Enter	Open menu or sub menu	when in main or sub menu
	Run selected function	if function is selected
UP	Cursor up	when in main or sub menu
Downt	Cursor down	when in main or sub menu
	Select signal input	when in main or PIP menu
	Open sub menu	when in main or sub menu

Left	Cursor to the left	when in sub menu
	Reduce value of the slider	if slider is selected
Right	Cursor to the right	when in sub menu
	Increase value of the slider	if slider is selected

The green/red LEDs on the external keypad show the current status of the board:

Color	Meaning	Remark
Green	Signal found	
Green blink	Search signal	
Red	Power safe mode	
LED off	Monitor off	

**Special functions of the controller:**

- PIP (Picture in Picture): Simultaneous display of two video sources on the screen with adjustable positions.
- PAP (Picture and Picture): Side-by-side display of two video sources.
- Tiling: Display of a video source on several monitors with mutually non overlapping frames.

**OSD menu**

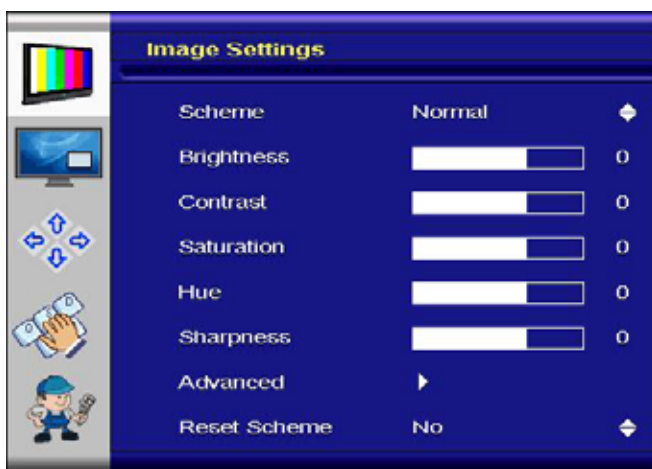

**Image Settings Menu**

- Scheme: Switches between normal/ sport/ game/ cinema/ vivid presets.
- Brightness: Panel brightness adjustment.
- Contrast: Panel contrast adjustment.
- Hue: Panel HUE adjustment (RGB, S-Video and Composite) only.
- Saturation: Panel saturation adjustment (RGB, S-Video and Composite) only.
- Sharpness: Panel sharpness adjustment.
- Advanced: Open Advanced sub menu.

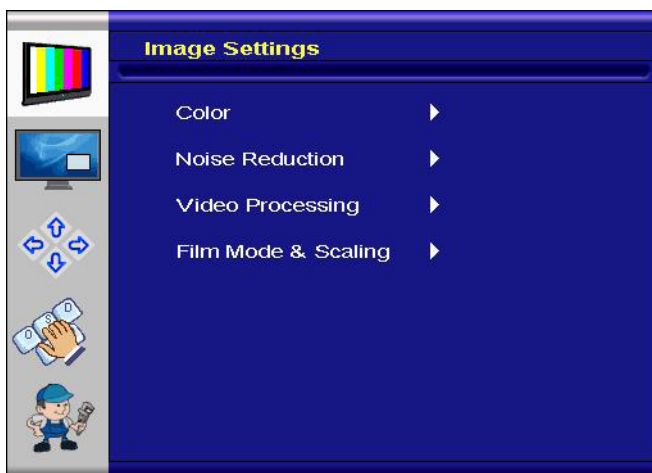

**Advanced Image Settings Menu**

- Note: Noise Reduction, Video Processing and Film Mode & Scaling are only available for RGB, S-Video and Composite signals.





#### Advanced Color Sub Menu

- Color Temp:** Allow selection of different color temperature schemes. Selections are user, sRGB, 4200K, 5000K, 5400K, 6500K, 7200K, 9300K.
- User Color:** Create custom color scheme.
- ADC:** Auto Color-Adjust. Performs auto fine tuning on the ADC (RGB, S-Video and Composite only).

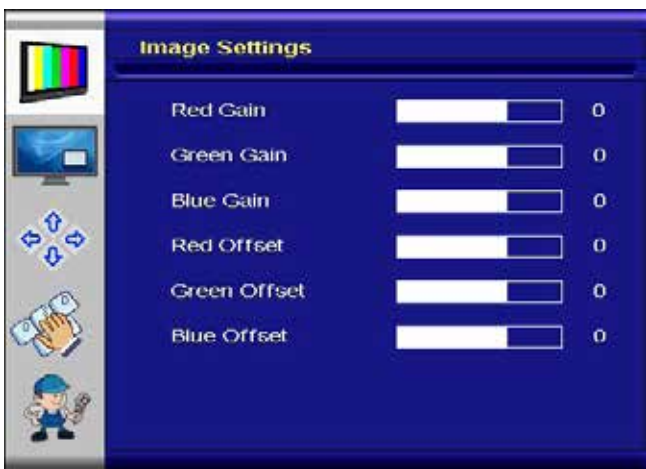

#### Advanced User Color Sub Menu

- Red Gain:** Boost adjustment on red.
- Green Gain:** Boost adjustment on green.
- Blue Gain:** Boost adjustment on blue.
- Red Offset:** Offset level on red.
- Green Offset:** Offset level on green.
- Blue Offset:** Offset level on blue.

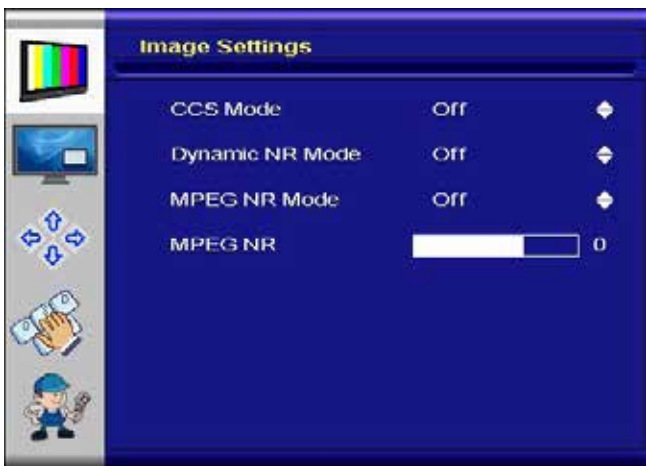

#### Advanced Noise Reduction Sub Menu

- CCS Mode:** Changes Cross-Color Suppression between off/ adaptive/ normal.
- Dynamic NR:** Changes Dynamic Noise Reduction between low/ medium/ high/ off/ adaptive. High setting may cause loss of detail, adjust for best image.
- MPEG NR:** Enables/ disables the MPEG NR Mode.
- MPEG NR:** Manual setting of MPEG noise reduction level.

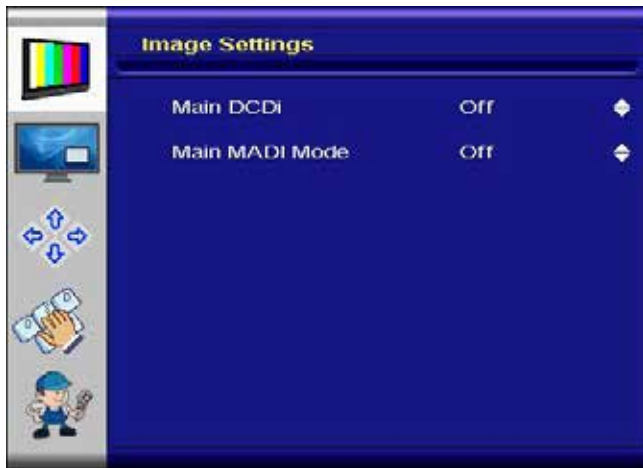

**Advanced Video Processing Sub Menu**

Main DCDi: Turns DCDi on/ off on main channel.  
 MADi Mode: Changes Motion Adaptive De-Interlacing among normal/ off/ adaptive modes.

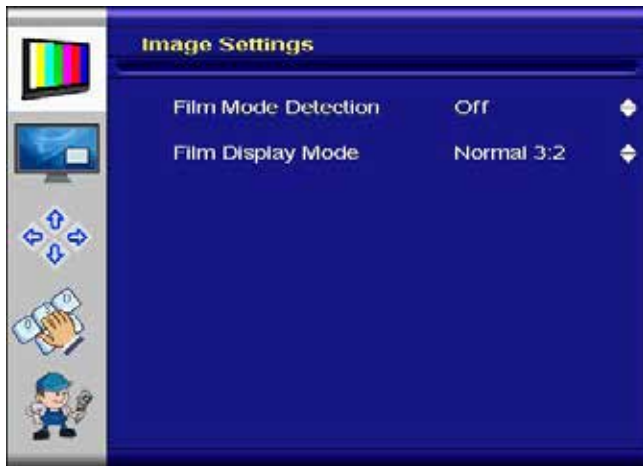

**Advanced Film Mode Sub Menu**

Detection: Selection of Video-3:2/ Video-2:2/ Video-3:2-2:2/ off.  
 Mode: Selection of Normal 3:2 or other future modes.



**Display Settings Menü**

Aspect Ratio: Used to adjust display among full screen, panoramic, letter box expand, pillar box, and 1:1.  
 PIP: PIP sub menu.  
 Tiling: Tiling sub menu.



### PIP (Picture in Picture) Sub Menu

- PIP mode: Toggle between Off, PAP-Tall, Side-by-Side, Small PIP and Large PIP.
- Vertical: Vertical position of PIP image.
- Horizontal: Horizontal position of PIP image.
- Transparency: Transparency of PIP image.

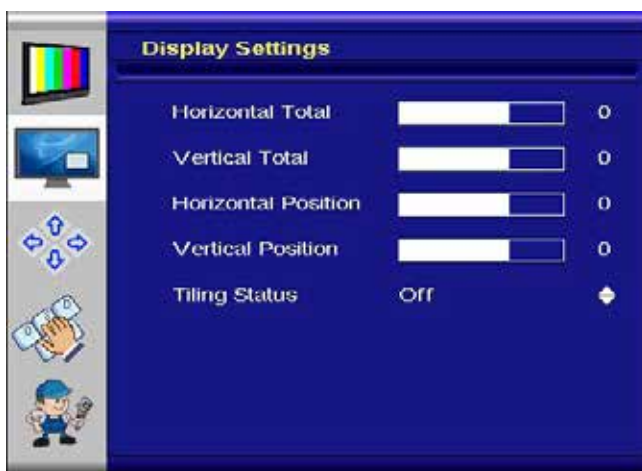

### Tiling Sub Menu (for video walls)

- Horizontal Total: Defines the total horizontal number of displays.
- Vertical Total: Defines the total vertical number of displays.
- Horizontal Position: Defines the horizontal position of the actual display unit.
- Vertical Position: Defines the vertical position of the actual display unit.
- Tiling Status: Enables/disables the tiling function. If the PIP-Mode is PAP-Tall or side-by-side, the tiling status will be off and disabled.

Example: 3 by 3 video wall: Definition of horizontal/ vertical display position:

Position	1	2	3
1	1 / 1	2 / 1	3 / 1
2	1 / 2	2 / 2	3 / 2
3	1 / 3	2 / 3	3 / 3

Note:

- Tiling property cannot be used while PAP-Tall or Side-by-Side modes are active.
- If PIP is turned on, the PIP image would be displayed on every panel of the video wall.
- Image and position menus are disabled while tiling is on.
- For best results, the Horizontal Total and Vertical Total value should to be set to a value which is an integer divider of the input width or height, respectively. For example, if input is 1280x768, horizontal total has to be set to one of 2, 4, 5, 8 and vertical total has to be set to one of 2, 3, 4, 6, 8.



**Position Settings Menu (for HDMI, S-Video and Component Video Signals)**

- Width:** Adjusts total width of the image by stretching or shrinking.
- Height:** Adjusts total height of the image by stretching or shrinking.
- Horizontal Start:** Changes the starting point of the image horizontally, without altering height.
- Vertical Start:** Changes the starting point of the image vertically, without altering width.



**Position Settings Menu (for RGB)**

- Auto Adjust:** Performs auto-adjust function on the image.
- Image Position.:** Image position sub menu.
- Phase:** Slider to adjust the sampling phase of the analogue interface. For optimum image quality, input pixels should be sampled at the ideal sampling points.
- Clocks/Line:** Slider to adjust the sample clock of the analogue interface. This is helpful for improving the image quality for non-standard display modes.
- Advanced:** Advanced Settings sub menu.



**Advanced Settings Sub Menu**

- Note:** This function can be used to manually force some of the widely used difficult-to-detect modes which can be misinterpreted by the controller.



Advanced Settings Sub Menu (HDMI mode only)



### OSD Settings Menu

Horizontal:	Move the OSD in horizontal direction.
Vertical:	Move the OSD in vertical direction.
Blend:	OSD transparency adjustment.
Time Out:	This function determines after how many seconds the OSD will close itself.
Horizontal Flip:	Flips the OSD horizontally.
Vertical Flip:	Flips the OSD vertically.
Rotation:	Rotates OSD.
OSD Zoom:	Changes OSD size.



### Setup Menu

Factory Reset:	Execute factory reset.
Speed Mode:	In graphics mode, fast image transfer is supported.
Show Menu Of:	Changes the menu between main image and PIP if the PIP mode is on.
Input Search:	Toggles input search on/ off.
Auto Brightness:	(Optional) Toggles automatic brightness control through external light sensor on/ off.
Firmware Version:	Installed Firmware Version.
OSD Version:	Installed OSD Version.

## 8. Maintenance

---

Systems with active cooling require cleaning of ventilation slots every 6 months. Systems with passive cooling must be cleaned every 12 months.

## 9. Guarantee / Service

---

### Guarantee

Data Display Group grants a manufacturer's guarantee of two years from the date of delivery.

The rendering of guarantee claims shall neither extend nor restart the guarantee period.

During the guarantee period, Data Display Group shall repair product faults based on material or production defects. The guarantee service is executed at Data Display Group's discretion through repair, replacement of defective parts or by exchanging a product for a product of equal quality without charging the customer for material or labor.

Guarantee claims are only accepted, if Data Display Group receives notification of a defective product within the guarantee period and the product is presented to the Data Display Group Service Centre together with all information as specified in the RMA process.

### Guarantee Exclusions and Limitations

This guarantee does not apply to any defect for which Data Display group is not responsible and which includes, but is not limited to the following:

- Unauthorized opening or disassembling of the product
- Faulty maintenance by non-observation of maintenance instructions
- Inappropriate storage or cleaning of the product
- Unauthorized modification of the product
- Incorrect use or misuse
- Non-observation of operating and installation instructions
- Permanent display of fixed images (causing image retention or image sticking)
- Operating the product in conditions which exceed the limitations of the specification
- Use of inappropriate boxes, packaging or modes of shipment
- Force majeure like fire, acts of war, acts of violence, chemical or biological impacts, lightning strikes, over voltage or similar events
- Fault resulting from the use of software which was not originally supplied with the product or which is incorrectly installed
- Normal wear and tear and wearing parts (i.e. LCD panel)

Mechanical damages like scratches, pressure or break points are excluded from this guarantee.

This guarantee does not include accessory parts which are not integral part of the product (as boxes, batteries).

Pixel errors only constitute a fault under the terms of this guarantee if they deviate from the product specification (i.e. ISO 9241-307 pixel failure class II).

## Display Quality - Prevention of after image burn in effects

After image burn-in means that an image or part of an image (i.e. logo) remains visible on the screen even if the image on the screen is changed. This should not occur if the LCD panel is operated in normal conditions with changing content. To prevent burn-in effects please follow the following guidelines.

- Do not display fixed patterns for an extended time period of more than 12 hours.
- Power-off the monitor for 4 hours after using it for 20 hours, and for 2 hours after using it for 12 hours.
- Use the power scheme and power management of the PC.
- Use plain-colored screen savers.
- Avoid patterns with a strong difference in brightness and contrast.
- Avoid gray colors.
- Change images and logos regularly. Show animated pictures for 60 seconds after 4 hours of operation.
- The best way to protect your display is to switch the monitor off when not in use or to use screen savers.

Non-observance of these guidelines may have effects on warranty.

## Guarantee Processing

Group RMA process. In order to avoid unnecessary charges, it is important to adhere to the RMA regulations.

Products must be appropriately and professionally packed for a safe return to the Data Display Group Service Centre. Products with panel sizes equal or larger than 81 cm (32") must be shipped on pallets in upright position.

Data Display Group does not assume liability for any customer data stored on products which are returned to Data Display Group.

## Limitations of Liability and Benefits

With this guarantee declaration, Data Display Group exclusively guarantees that the product is free of material and manufacturing faults.

Data Display Group does not issue any other guarantee or similar statements other than this declaration.

This guarantee does not impair or affect a buyer's statutory claim against the seller due to material damage. Such claims can be asserted instead of the guarantee agreed to here at the buyer's discretion.

Mandatory legal rights and mandatory claims under the German Product liability remain unaffected.

## Applicable Law and Place of Jurisdiction

The laws of the Federal Republic of Germany apply.

Place of jurisdiction is Munich.



## Service addresses

### Germany

Distec GmbH  
Augsburger Str. 2b  
D-82110 Germering  
☎ +49 (0)89 / 89 43 63 0  
✉ support@distec.de

### England

Display Technology Ltd.  
5 The Oaks Business Village  
Revenge Road, Lordswood  
Chatham, Kent, ME5 8LF  
☎ +44 (0)16 34 / 67 27 55  
✉ info@displaytechnology.co.uk

### USA

Apollo Corp.  
87 Raynor Avenue, Unit 1  
Ronkonkoma NY 11779  
☎ +1 (1)631 / 580-4360  
✉ info@apollodisplays.com

Please go to the following web address for further information about our RMA regulations and RMA forms:  
[Http://www.datadisplay-group.com/service](http://www.datadisplay-group.com/service)

## 10. Disposal

---

### Disposal of old devices

If the acquired Distec product is to be disposed of, must be implemented into national law the Directive "2012/19 / EU".



### Disposal of batteries

Applicable in all countries of the EU and in countries with separate battery collection systems.

The Batteries in this product should not be disposed with other household waste. The chemical symbol Pb, CD or Hg indicate that the battery contains lead, cadmium or mercury above the reference level in EC directive 2006/66.



Batteries which are not disposed correctly can cause harm environment and health.

Our environment is close to our hearts. Please help us to protect our environment and recycle empty batteries with the free battery collection system.

## 11. Declaration of Conformity

---

### Declaration

Hereby the Distec GmbH declared that the unit EU is in compliance with the essential requirements and other relevant provisions of Directives 2014/30 / EU and 1999/5 / EC and 2014/35 / EU and 2011/65 / .

The CE declaration of conformity can be found in English on the enclosed companion DVD.