

# User Manual

## POS-Line Series

---

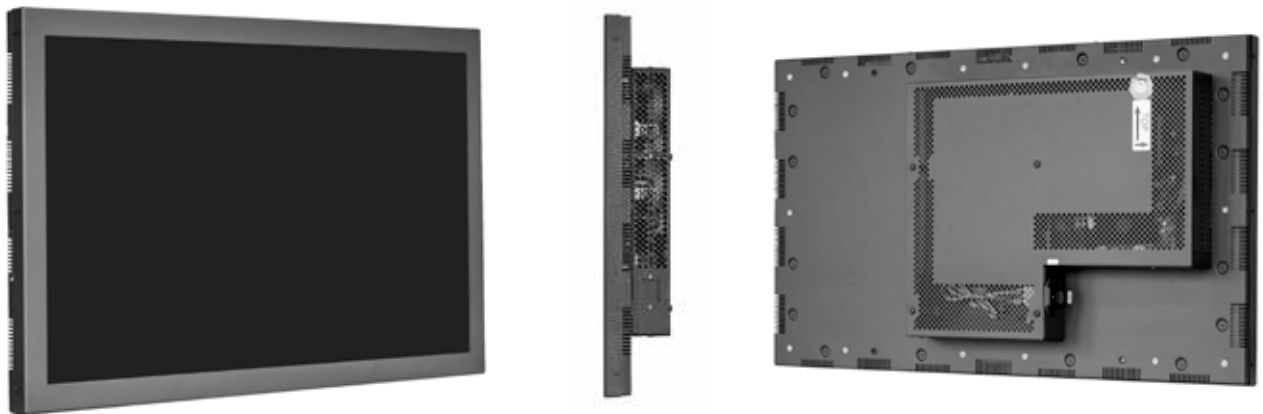

POS-Line monitors from 80 cm (31.5")



## Copyright

The contents of this manual are subject to change without notice.

© 2021 Distec GmbH. All rights reserved.

Reproduction of this manual in parts or entirely without the previous authorization of Distec GmbH is prohibited.

Distec GmbH is not liable for errors and collateral or subsequent damage which result from supply, deployment or any other utilisation of this document.

All product names mentioned in this document are trademarks or registered trademarks of their due owners.

## Table of Contents

1. General Specifications .....	4
2. Chassis Versions.....	5
3. Scope of Delivery .....	7
4. General Safety Regulations .....	8
5. First Installation.....	11
6. Touch Sensors.....	15
7. Ambient Light Sensor .....	15
8. POS-Line Video PME.....	16
9. POS-Line Video PIII .....	24
10. POS-Line IQ Intel Celeron.....	33
11. POS-Line IQ Core™-i5.....	39
12. POS-Line VideoPoster.....	45
13. POS-Line IoT .....	50
14. WebPoster .....	53
15. Maintenance .....	55
16. Warranty / Service .....	55
17. Disposal.....	57
18. Declaration of Conformity .....	58

## 1. General Specifications

---

### Scope of Document

This user manual is valid for POS-Line monitors up to 139 cm (54.6"). The POS-Line monitors are offered in different screen sizes and with various controllers and other options.

**Important note:** This user manual is complemented by other additional documents when indicated.

All documents are also available for download from Data Display Group web site: [www.distec.de/en](http://www.distec.de/en).

### POS-Line monitor versions:

POS-Line Video PME:	Monitor with integrated AD converter board, 1 x RGB, 1 x HDMI, 1 x Display Port
POS-Line Video PIII:	Monitor with integrated AD converter board, 1 x RGB, 1 x DVI, S-Video, Composite Video
POS-Line IQ Celeron:	Monitor with integrated PC board Intel® Celeron® J3455 (1,5GHz/2,3GHz)
POS-Line IQ Core-i:	Monitor with integrated PC board Intel®KU173-NB-7300U; CPU: Intel® Core™ i5
POS-Line VideoPoster:	Monitor with integrated network media player for video play lists
POS-Line IoT:	Monitor with integrated Raspberry® Pi CM3+ ARM Modul..

## 2. Chassis Versions

---

Various front bezels are available for POS-Line displays. A front bezel changes the look of the display.



Note: All photos and graphic representations in this document show open frame displays. All explanations shall also apply to displays with front bezel.

### Displays with various front bezel designs:

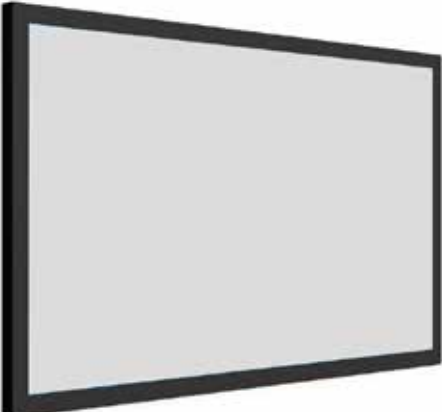
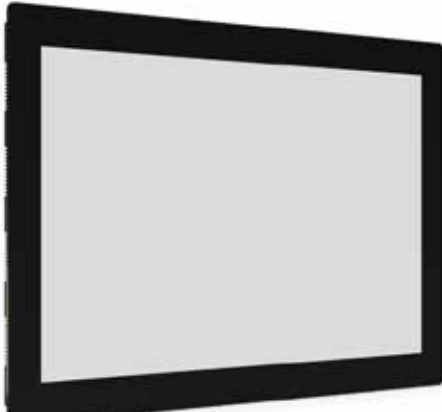
<p>Open frame display (without bezel)</p> <p>For mounting with angles or VESA mounts.</p>	 A perspective view of a rectangular display panel with a thin black border. The panel is tilted slightly, showing its depth. The display area is a uniform light gray.
<p>Display with front bezel</p> <p>For VESA mounts.</p>	 A perspective view of a rectangular display panel with a thick, solid black bezel. The panel is tilted slightly, showing its depth. The display area is a uniform light gray.
<p>Display with true-flat glass</p> <p>For VESA mounts.</p>	 A perspective view of a rectangular display panel with a thick, solid black bezel. The panel is tilted slightly, showing its depth. The display area is a uniform light gray.

Display with true-flat glass and bezel  
For VESA mounts.



Display with aluminum bezel  
For VESA mounts.

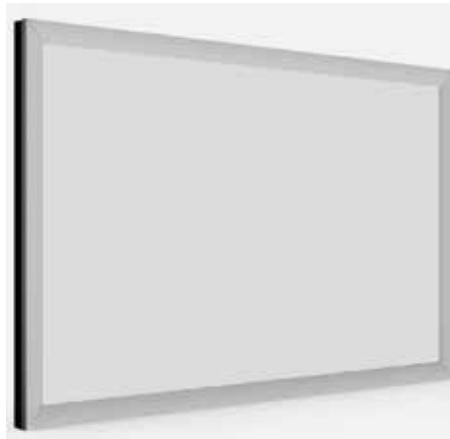

### 3. Scope of Delivery

---

When unpacking the monitor, please check if the following accessories are included in the shipment:



Note: Pictures can differ from actually supplied products.



Product information



RGB cable



USB cable\*



Power cord\*\*



USB stick\*\*\*



screw cover\*\*\*\*

\* Displays with touch sensor only

\*\* Cable may vary depending on country

\*\*\* POS-Line VideoPoster series only

\*\*\*\* POS-Line 65" only

# 4. General Safety Regulations

---

## Safety information

Please read this safety information carefully for your personal safety and for the prevention of property damage.

In case of a malfunction, immediately disconnect the power plug and contact your dealer or the next Data Display Group service centre. A malfunction is also considered if the housing, a control element or cable is damaged or if liquids or other objects penetrate the monitor.

Please read the safety information carefully before installing the device. If you have any doubts about whether the device may be used in a particular environment, please contact our service partner.

## Repairs

Repairs may only be carried out by authorized technical personnel. Unauthorized access or improper repairs might cause serious property damage or cause danger to the user. In addition to that, any legitimate warranty claim expires.

## Electrical connection

Disconnect the monitor from socket before executing any work. Do not touch or connect data cables or power cables during thunderstorms.

## System start-up

Before the system start-up let the monitor adjust to the room temperature. Do not expose the device to direct heat sources. In case of condensation, please wait a minimum of 12 hours before switching on the monitor. The monitor shall only be installed and used according to this documentation data sheets. Only qualified personnel may perform the initial installation and system setup.

## Qualified personnel

Qualified personnel, in terms of the safety information of this documentation, are persons who are qualified to activate, ground and label devices, systems and circuits according to the safety standards.

## Operation

For a proper and safe utilization of the product, adequate transportation, storage, installation, assembly, careful handling and maintenance are essential. The device is only certified for in-door operation. Extreme ambient conditions shall be avoided and the monitor shall be protected from dust, humidity and heat. Do not expose the monitor to direct sunlight.

## Transport

Unpack the monitor at the place of installation. Use only original packaging for transportation. Please observe these rules for any later transport.

## Condensation

Avoid condensation during transport at low temperatures or at extreme fluctuations of temperature.





### Safety guidelines for the handling of LCD monitors

- If the device is not used for a long period of time, unplug the power cable.
- Do not unplug the power cable while the device is powered on, except for emergencies.
- To unplug the device without problems, sockets have to be easily accessible.
- Ensure that the power cable does not get pinched or kinked.
- Do not place heavy objects on the power cable.

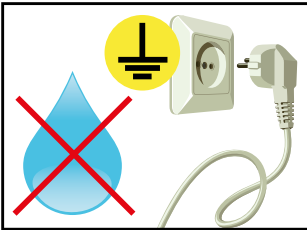

- Do not use damaged or loose sockets to plug in the device.
- Plug the device in earthed sockets only.
- Operate the device with the power cables included in the delivery packet only.
- Use undamaged power cables only.
- When plugging in and out, do not touch the power cable with wet hands.
- Ensure that the power cable is plugged in the socket safely and correctly.
- Use for devices with external power supply only the supplied original power supply, or an equivalent Low Power Source (LPS).

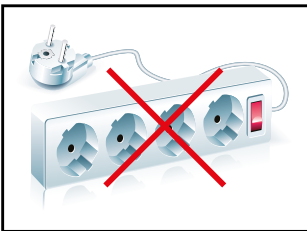

- Do not use extension block to plug several devices into a single socket.



- According to the size, devices may be difficult to handle and very heavy. Ensure that at least two people lift and carry the device.
- Put down the device slowly and carefully to avoid damaging the LCD screen. Ensure that the device stands stable.
- Keep packaging away from children. Danger of suffocation!
- Use our specified and professionally mounted wall mounting only.



- Do not put objects onto the device.
- Do not place candles, heaters or humidifier near the device.
- Keep the device away from fireplaces and flammable materials.

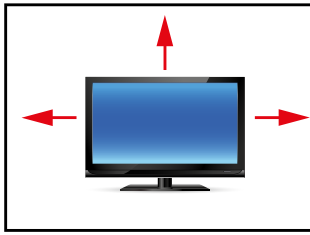

- Ensure sufficient ventilation of the device.
- Keep a minimum distance of at least 10 mm devices to the wall, for devices with integrated PC of at least 40 mm.
- Ensure compliance with the operating temperature.

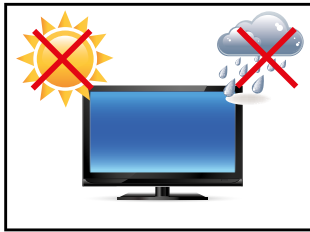

- Do not install the device in places where it is exposed to environmental impacts such as rain or direct sunlight.
- Do not install the device in places where it is exposed to high humidity, dust or smoke. In case of doubt, please contact your sales partner.



- Please use a soft, moist cloth for cleaning.
- For cleaning the screen, please use only commercially available screen cleaner. Do not spray the cleaner directly to the device but onto a cloth.
- Please clean ventilation slots regularly to ensure a good air circulation.

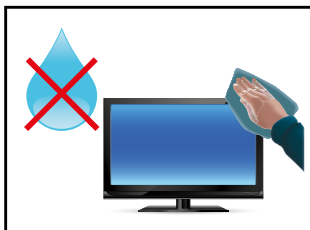

- Protect your device from water splash.
- When cleaning, please make sure that no liquids get into the device.
- Screens and surfaces can be easily scratched. Therefore, please use the prescribed cloth only.



- Attention! High voltage! Never open the device by yourself.
- In case of unusual noises, burnt smell or smoke unplug the power cable.
- Do not insert objects into the device through the ventilation slots.
- If the same picture is displayed over a longer period of time, an after-image may arise.
- When exchanging batteries of the remote control, pay attention to the polarity. Keep batteries away from children and ensure an environmentally correct disposal.

## 5. First Installation

### Position of connectors and controls

All connectors for power and cables are located at the bottom of the back side of the display.

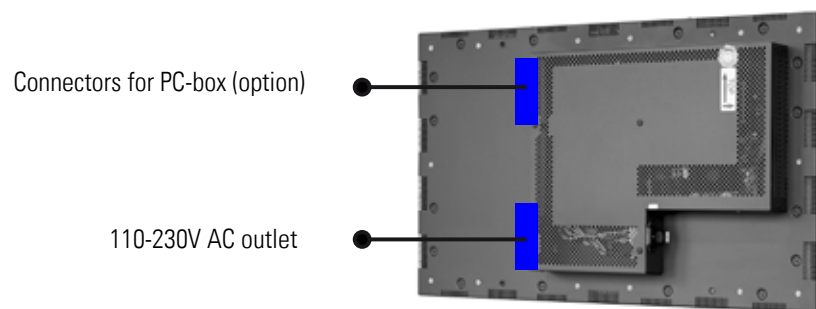
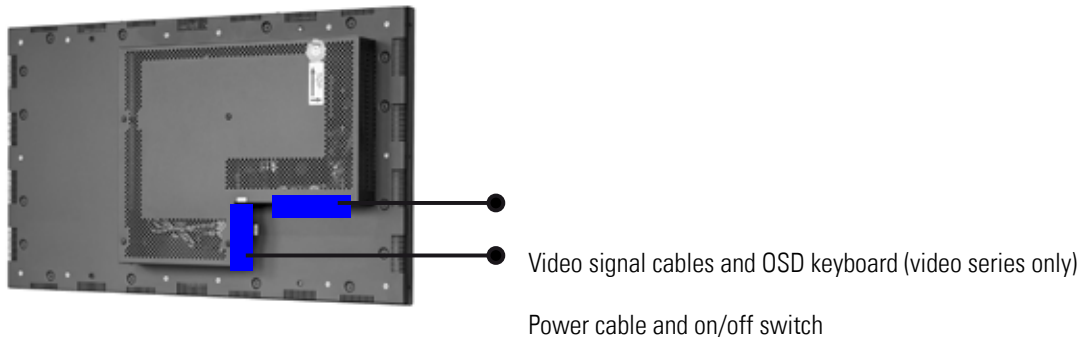

### Mounting

Distance to wall:

- devices without integrated PC: min.10 mm
- devices with integrated PC: min. 40 mm

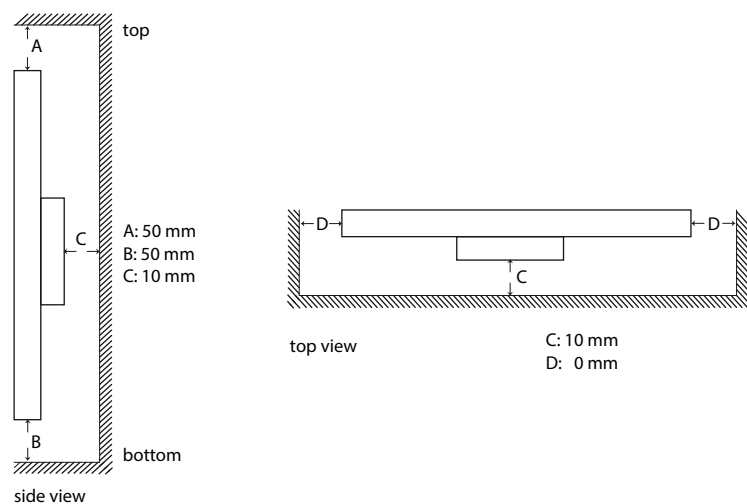

## Mounting with VESA compatible brackets

POS-Line displays are shipped with factory installed mounting angles for VESA compatible brackets. The mounting angles are, without further modification suited for landscape or portrait mode and comply with the minimum required distances between the back side of the display and the wall.

The operating position of the device is perpendicular (90 degrees to the floor). Pay attention to the permissible tilt angle for wall mounting.

The device can be operated both in landscape mode and in portrait mode. The information is for positioning to note on the back of the device, always.

For mounting on the pre-assembled VESA brackets, a suitable wall bracket must be used whose load-bearing capacity corresponds to the weight of the monitor. For fastening to the VESA brackets, use 4 metal screws of size M6x25.

To mount / dismantle the lifting aid (eyebolts), please refer to the enclosed "Mounting Instructions" on the enclosed DVD.



VESA standards:  
31.5" - 54.6" displays: MIS-F 400 x 400 mm (M6)

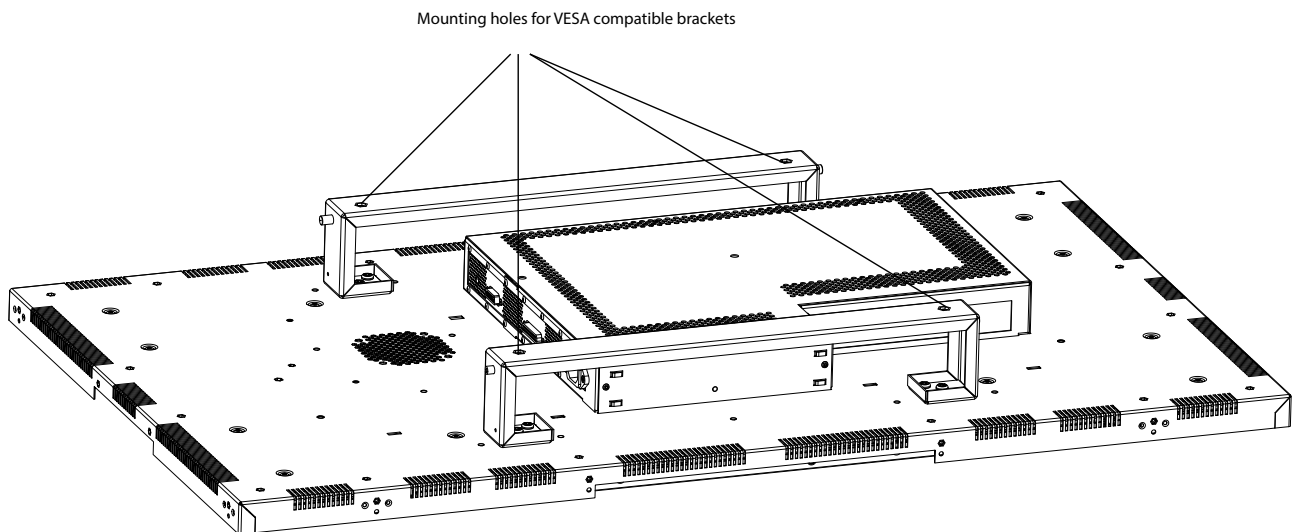

VESA standards POS-Line 65": MIS-F 800 x 800 mm (M6)

VESA mounting points M6, 20 mm deep

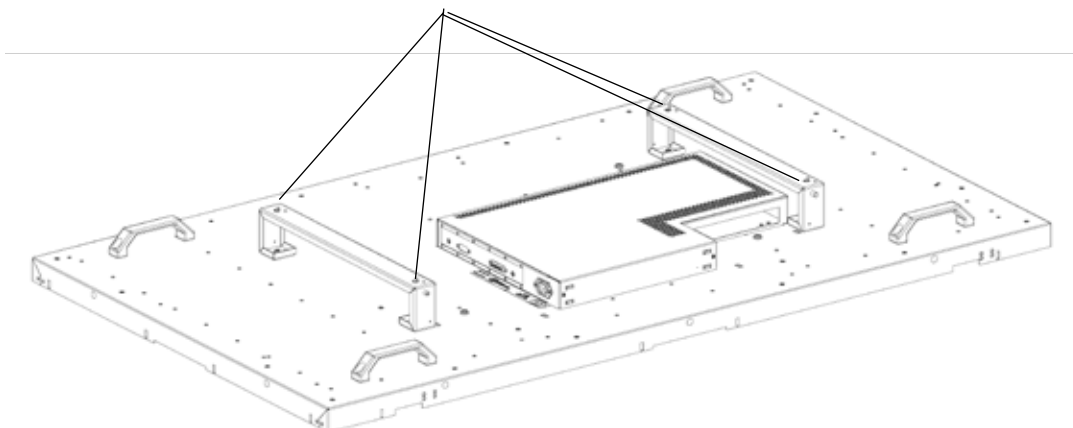

## Eye-Bolts for mounting and stabilising

### Eye-Bolts for 65" mounting and stabilising

Eye-Bolts manufactured to DIN 580:2010-09

Before use, Eye-Bolts must be carefully examined for visible defects ( for example corrosion, or deformation, ) and correct seating. Eye-Bolts showing signs of deformation or defect must not be used in any application.

Marking Eye-Bolts in colour after delivery (especially in red) is to be avoided, to prevent confusion with high-strength attachment positioning indicators.

Eye-Bolts manufactured to DIN 580 can be used freely in applications within a temperature range of - 20 °C to +200°. If the bolt is to pass through a hole, a nut of at least 0,8 x d should be screwed tightly on the back side. If the thread length is long enough, the use of a washer is recommended. Eye-Bolts conforming to this standard serve chiefly as load-bearing aids for permanent anchorage of components in transport, such as motors; switch cabinets; gear boxes and so on.

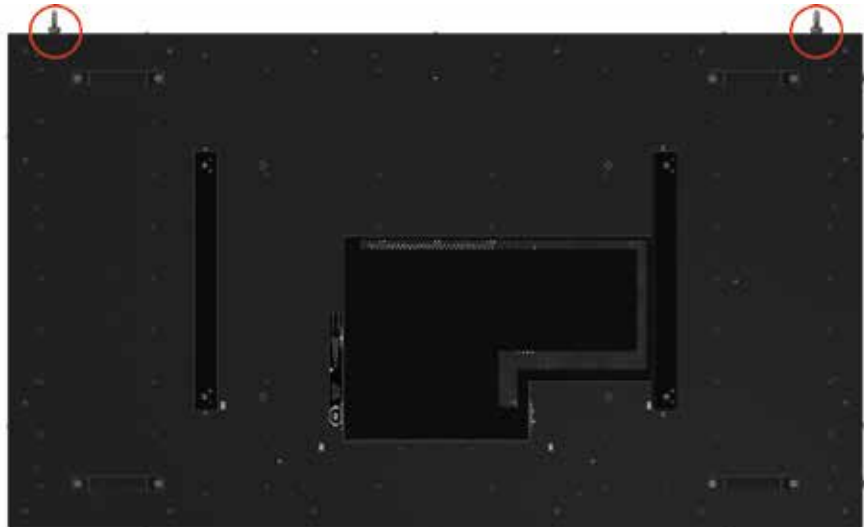

### Load Capacity

A axial (WLL) per Eye-Bolt B per Eye-Bolt  $\leq 45^\circ$  C  
Lateral per Eye-Bolt  $\leq 45^\circ$



ATTENTION! Do not pull sideways!

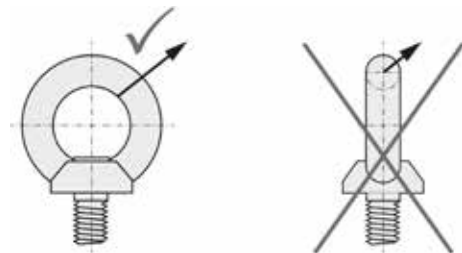

## Anchorage points for raising and securing of the Monitor

These points can be used to secure the equipment permanently on suitable chains or cords.

For permanent fixation of the monitor, both anchorage points must always be used!

Chains or cords should feed vertically to the anchorage points!

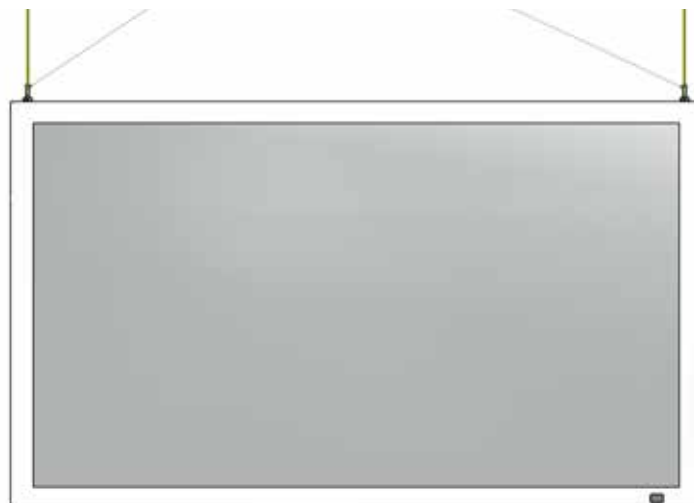

## Allowed tilt angle for mounting



Attention! All monitors are not allowed to be mounted with a tilt angle of  $0^{\circ}$  -  $+180^{\circ}$ .

The following monitors may be mounted only with a tilt angle of  $0^{\circ}$ :

- All monitors with true flat glass
- All monitors with safety glass/ touchscreen and without bezel

The following monitors may be mounted only with a tilt angle of  $0^{\circ}$  to  $-30^{\circ}$ :

- All monitors without safety glass, true flat glass or touchscreen

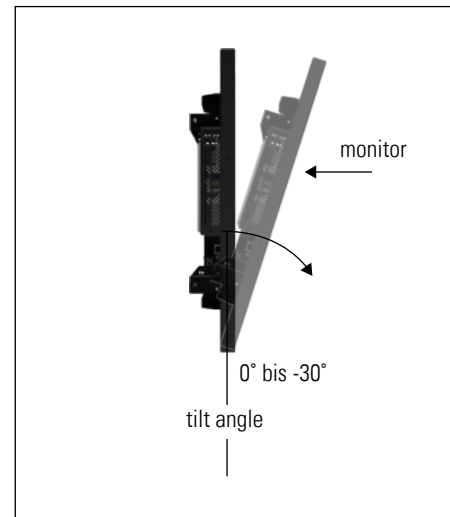

## Connecting to power

POS-Line displays require a voltage of 110V - 230V AC.



Note: Install all data cables to external devices before connecting the display to power.

- Switch the on/of switch in position off.
- Connect the power cable to the display.
- Connect the power cable to a power socket.
- Switch the display on .

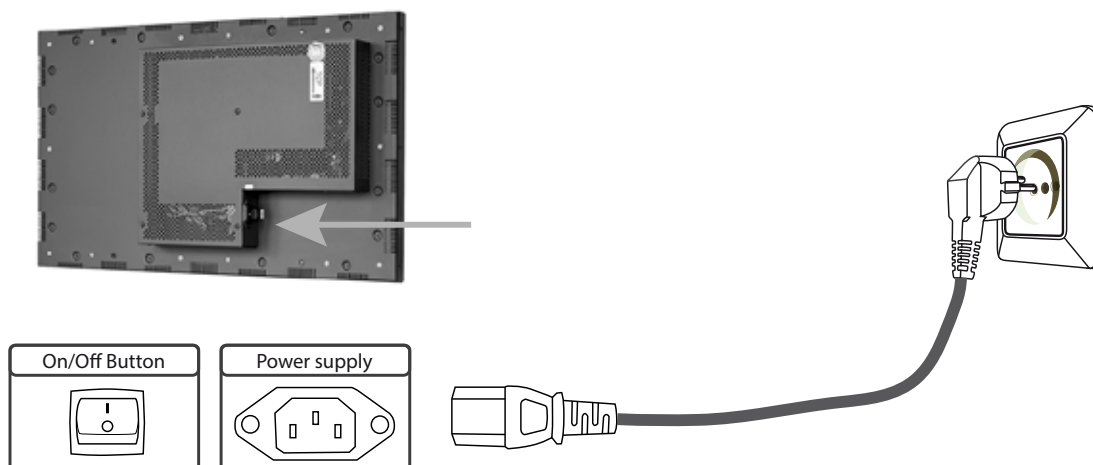

## 6. Touch Sensors

---

POS-Line monitors are available with touch option. Depending on the panel size, different touch systems and touch technologies are used. If the monitor has been ordered with touch option, the touch sensor and touch controller are installed at factory.

### POS-Line IQ:

The actual touch driver is pre-installed on these systems if ordered with operating system. The touch can be put directly into operation.

### POS-Line Video:

The drivers for these monitors must be installed on your PC system. HID devices do not need drivers for Windows 7 and 8. Please contact our support center if you are using LINUX based computers.

If a driver is required, the touch on this driver must be calibrated. Is it a HID Touch, Windows calibration in the control panel must be performed.



path:

Control Panel \ All Control Panel Items \ Tablet PC Settings

**Note:** All drivers for the touch sensors can be found on the enclosed DVD.

## 7. Ambient Light Sensor

---

POS-Line monitors can be optionally equipped with an ambient light sensor. If you have ordered your POS-Line with an Ambient Light Sensor option, the sensor is already mounted in the factory (see picture). It is possible to dismantle the ambient light sensor and thus adjust the position individually. However, this is only possible if the Ambient Light Sensor is installed in conjunction with the Open Frame Option.

Below you will find the description for disassembling the Ambient Light Sensor.

The attachment of the Ambient Light Sensor has been realized via a M3x6 Torx screw. To remove the sensor, this screw is disassembled. The ambient light sensor can now be removed from the holder and the sensor with the cable pulled out by 43 cm. The disassembled Ambient Light Sensor is to be mounted as before disassembly, over the screwing point on the sensor. In order to ensure the function of the Ambient Light Sensor, it must not be obscured, as otherwise the automatic brightness control of the device will always cause the monitor to go dark.

Position Ambient Light Sensor:

ALS



## 8. POS-Line Video PME

Connectors and OSD buttons of POS-Line Video PME series

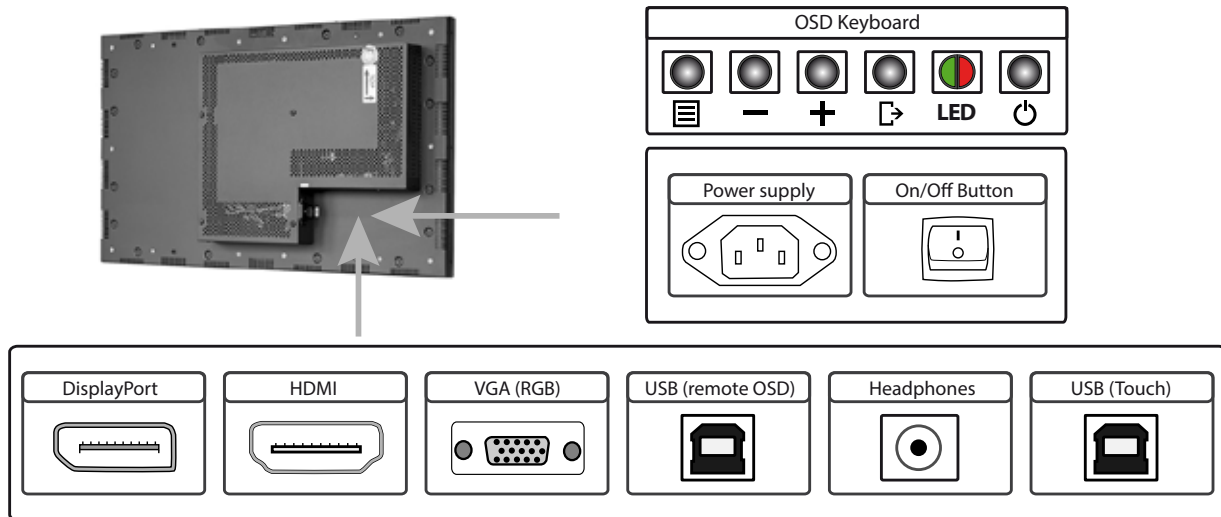

Connecting to a PC with VGA cable

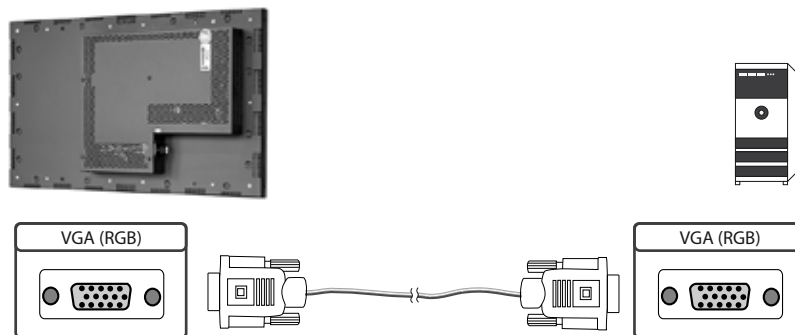

Connecting to a PC with HDMI-DVI cable

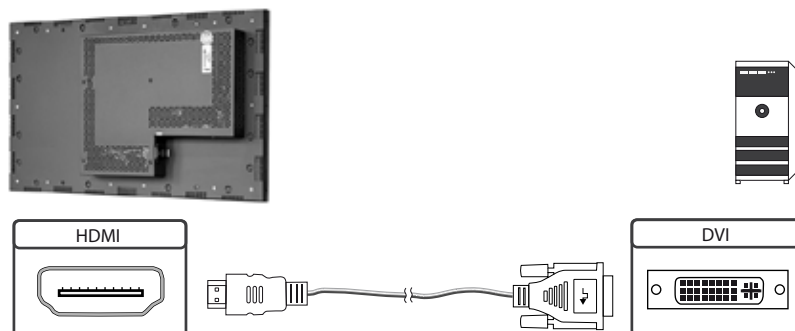



Connecting to a PC with HDMI cable

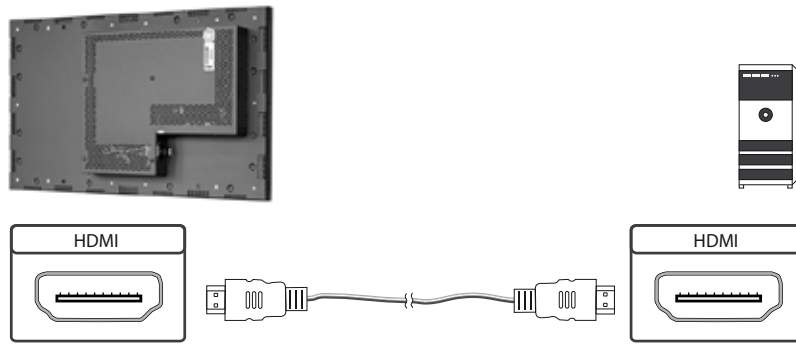

Connecting to a PC with DisplayPort cable

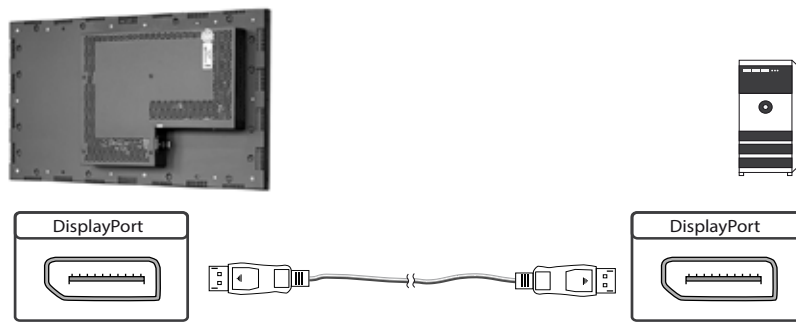

Connecting the Remote-OSD to a PC with USB cable

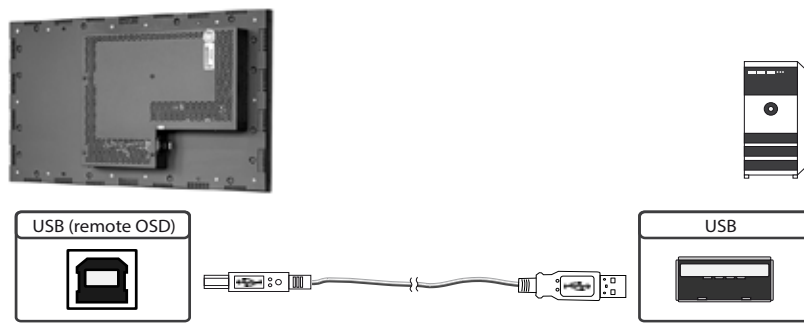

Connecting the touch to a PC with USB cable (for displays with touch sensor only)

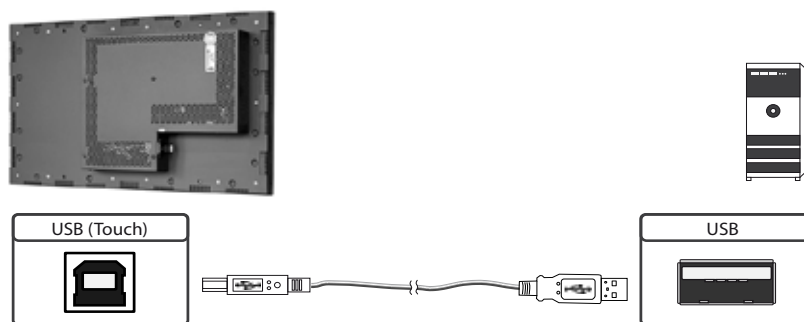

## Remote OSD control

You can control the monitor remotely from an external computer. To do this, connect the monitor and computer as described above a USB cable. Please read the instructions for the remote control, which you can find on our homepage: <https://www.distec.de/en/service/downloads/monitore-downloads/>.

## OSD keyboard

OSD functions of the monitor can be controlled via OSD key pad. The OSD allows selection of input source and fine tuning of various functional parameters like brightness, contrast etc.

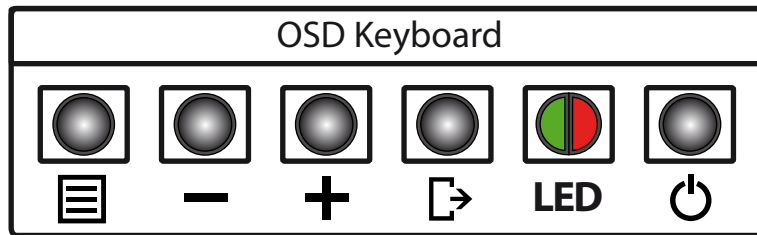

The OSD control can either be used:

- to access various functions directly
- to navigate within the OSD

The following two tables give an overview about the functions:

Direct functions:

Key	Function	Comment
Menu	Open the OSD menu	
—	Open volume control	
+	Open brightness control	
Exit	Select signal input	
Power	On/ Off	

Navigation in OSD menu:

Key	Function	Comment
Menu	Open sub menu	when in main
	Confirm entry	when in main
—	Cursor down	when in main or in sub menu
	Cursor/ slider to the left	when in main or in sub menu
+	Cursor up	when in main or in sub menu
	Cursor/ slider to the right	when in main or in sub menu
Exit	Leave OSD menu	when in main
	Leave sub menu	when in sub menu

The green/red LEDs (single package) on the external keypad show the current status of the board:

Color	Meaning	Remark
Green	Signal found	
Green blink	Search signal	
Red	Power safe mode	
LED off	Monitor off	

### OSD menu

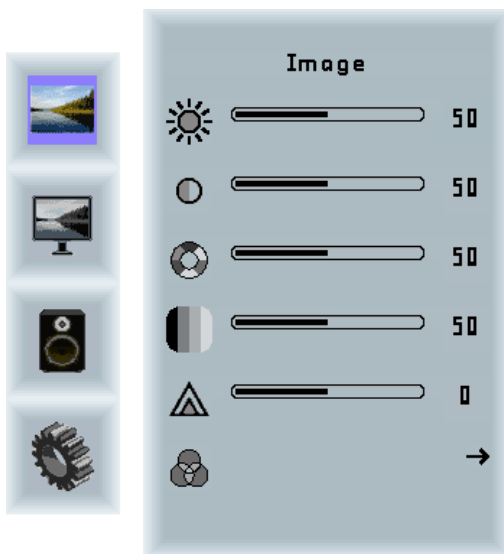

#### Image Menu

- Brightness: Panel brightness adjustment.
- Contrast: Panel contrast adjustment.
- Hue: Panel hue adjustment.
- Saturation: Panel saturation adjustment.
- Sharpness: Panel sharpness adjustment.
- Color: Opens the color sub menu.



#### Color Sub Menu

- Auto: Performs auto color adjustment.
- Color Temp: Allow selection of different color temperature schemes, predefined and custom. Available if color space of input is RGB.
- Full color: Selects full received color space.
- SRGB: Selects SRGB color space.
- XVYCC: Selects XVYCC color space.

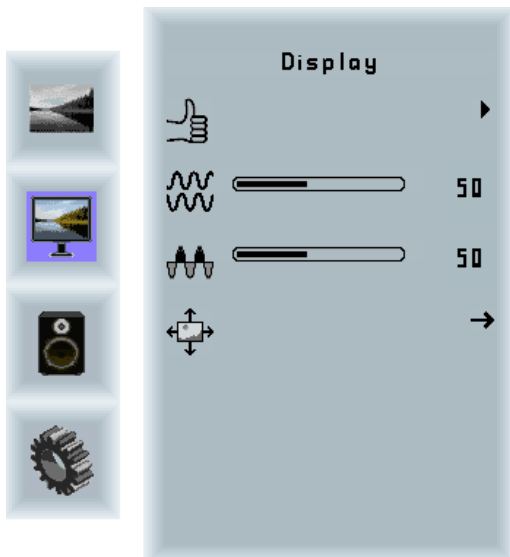

**Display Menu**

- Auto-adjust:** Performs auto-adjustment on the VGA input image.
- Phase:** This function is a slider to adjust the sampling phase of the analogue interface. For optimum image quality, input pixels should be sampled at the ideal sampling points.
- Clock:** This function is a slider to adjust the sample clock of the analogue interface. This is helpful for improving the image quality for non-standard display modes.
- Position:** Used to alter placement of the image.

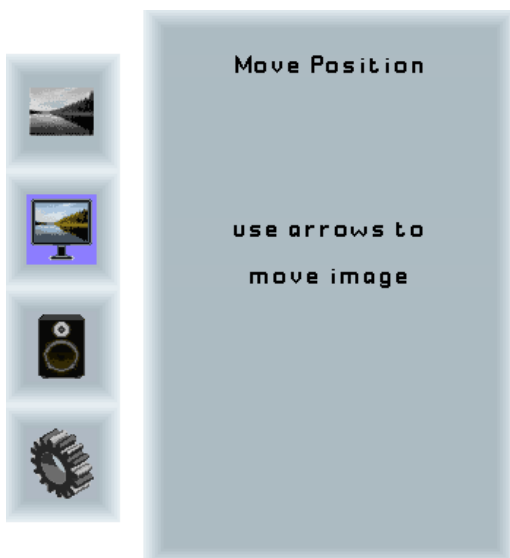

**Move Position Sub Menu**

- Arrows:** Use arrow keys to move the position of the image on the screen.

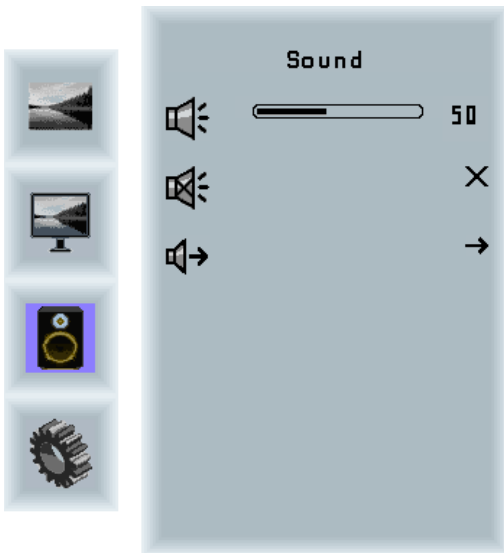

**Sound Menu**

- Volume: Slider bar to adjust volume.
- Mute: Mutes audio.
- Output: Chooses between speakers and headphone. Only one can be active at a time (Speakers are not available for POS-Line monitors).

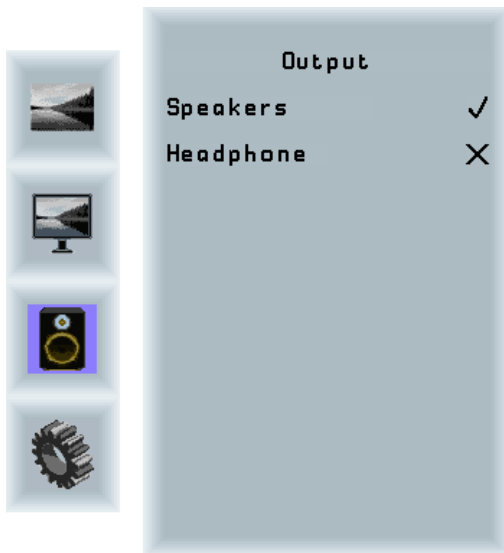

**Output Sub Menu**

- Speakers: Toggles speakers on/ off.
- Headphone: Toggles headphone on/ off.



**System Menu**

- Input source: Sub menu to select input source.
- OSD settings: Sub menu for OSD settings.
- Factory reset: Sub menu for Factory Reset.
- EDID settings: Sub menu for EDID settings.
- FW Revision: Firmware revision.
- OSD Revision: OSD revision.

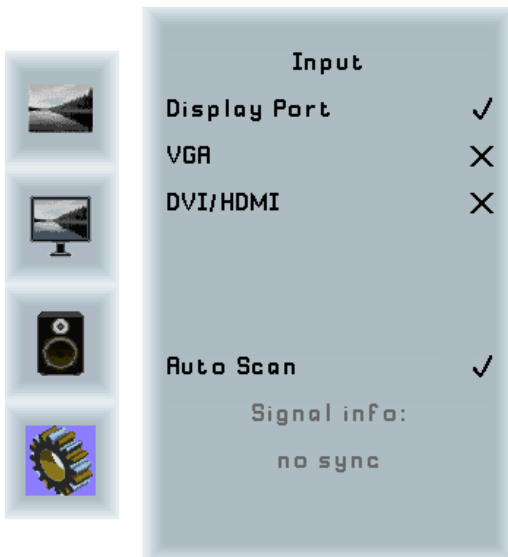

### Input Sub Menu

- Display Port: Select display port as input signal.
- VGA: Select VGA as input signal.
- DVI/HDMI: Select DVI/ HDMI as input signal.
- Auto Scan: Enable/ disable input auto-scan.



### OSD Settings Sub Menu

- Timer: Sub menu for timer settings.
- Rotation: Sub menu for rotation settings.
- Position: Sub menu for image position.
- Transparency: Slider to set transparency.



### Timer Sub Menu

- Timer: Selects how many seconds the OSD will remain active after the last use.

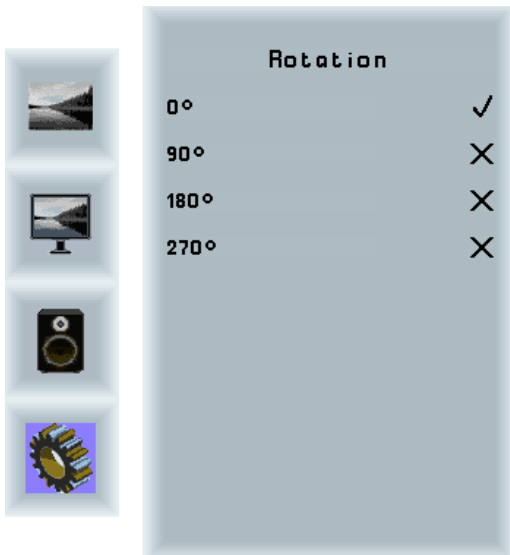

Rotation Sub Menu

Rotation: Rotates the OSD menu.



Reset Sub Menu

Reset: Performs factory reset.



EDID Write Protect Sub Menu

Write protect: EDID write protect on/ off.

## 9. POS-Line Video PIII

Connectors and OSD buttons of POS-Line Video PIII series

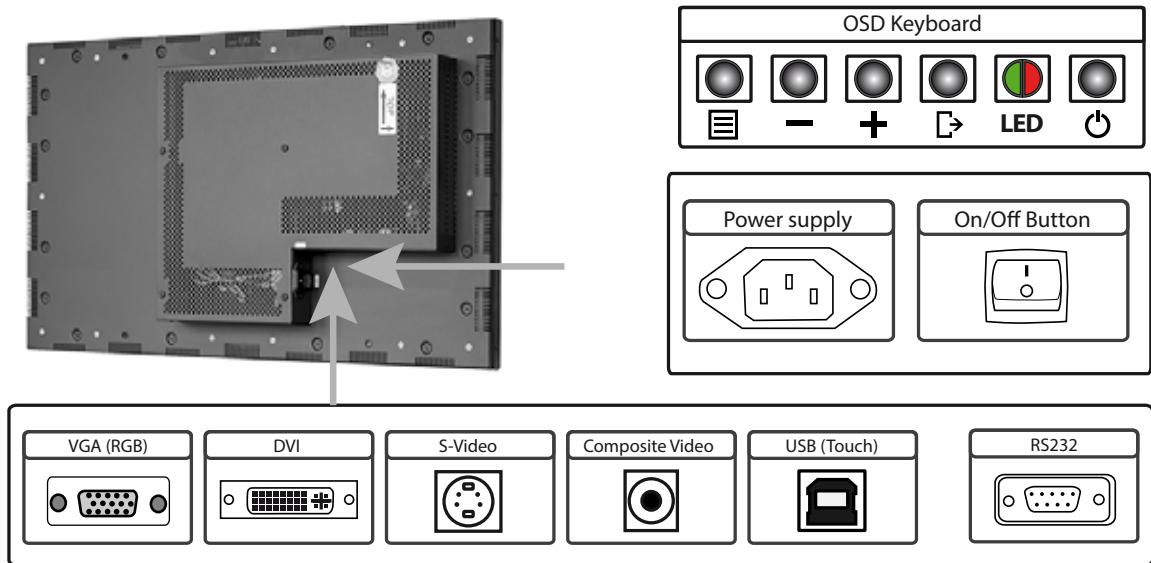

Connecting to a PC with VGA cable

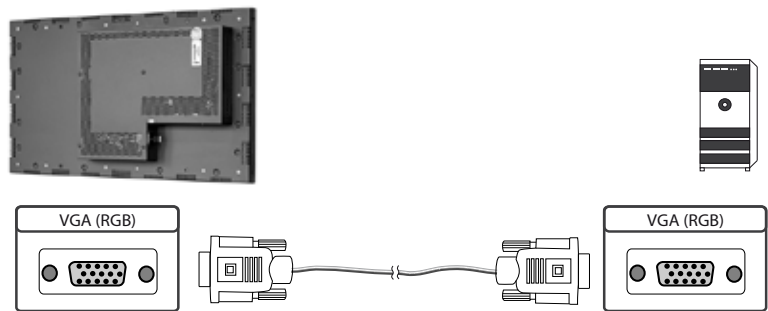

Connecting to a PC with DVI cable

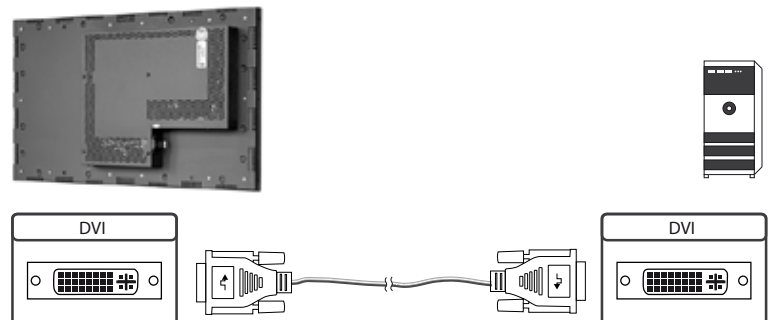

Connecting to a PC with DVI-HDMI cable

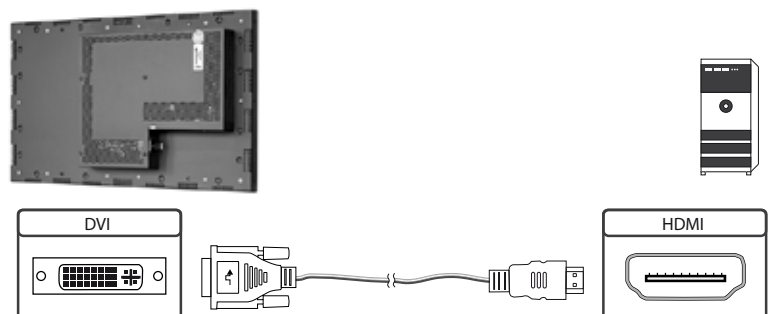



Connecting to an external device with S-Video cable

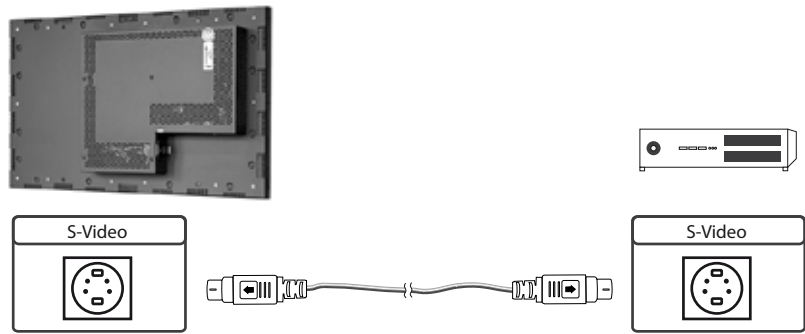

Connecting to an external device with Composite Video cable

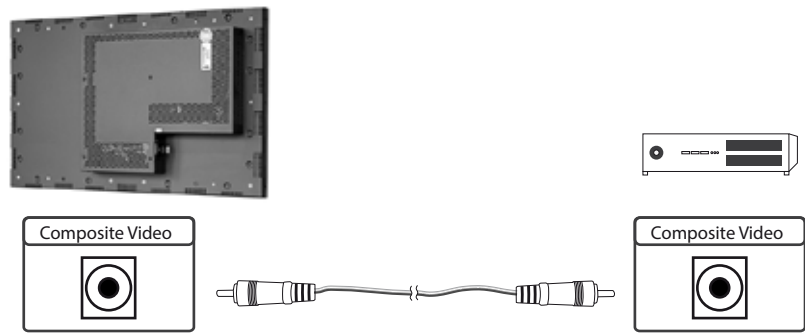

Connecting the Touch to a PC with USB cable (for displays with touch sensor only)

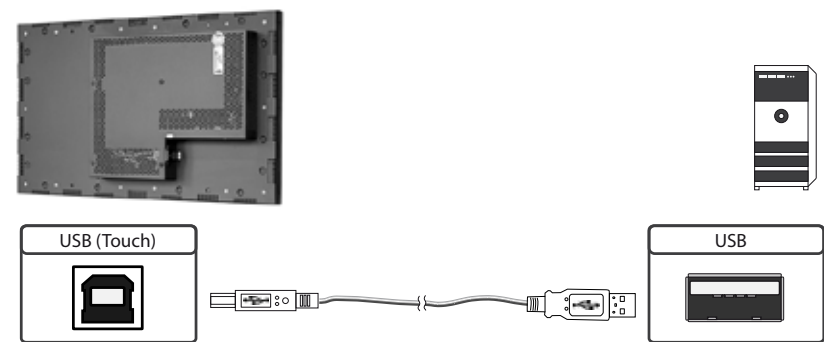

Connecting the Touch to a PC with RS232 cable (for Remote OSD only)

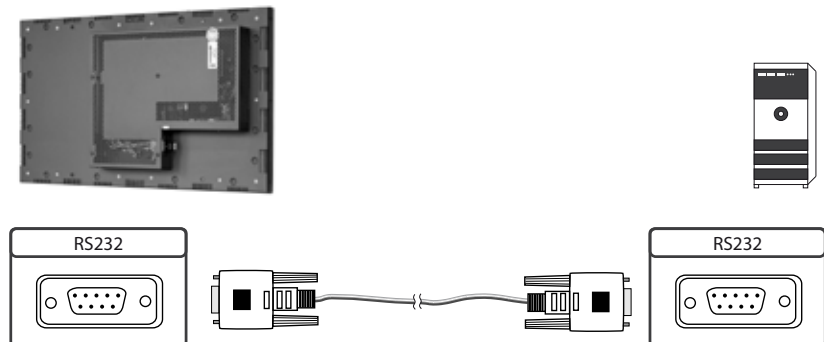

## Remote OSD control

You can control the monitor remotely from an external computer. To do this, connect the monitor and computer as described above a USB cable. Please read the instructions for the remote control, which you can find on our homepage: <https://www.distec.de/en/service/downloads/monitore-downloads/>.

## OSD keyboard

OSD functions of the monitor can be controlled via OSD key pad. The OSD allows selection of input source and fine tuning of various functional parameters like brightness, contrast etc.

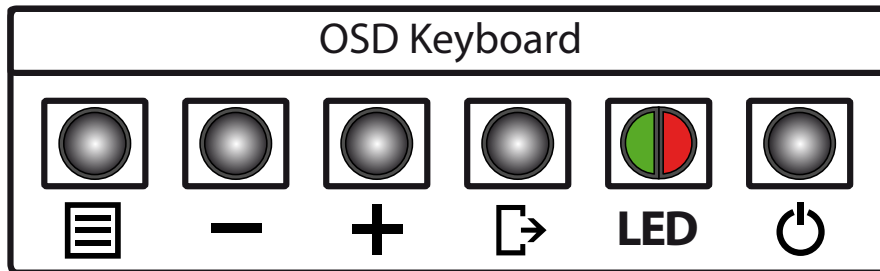

The OSD control can either be used:

- to access various functions directly
- to navigate within the OSD

The following two tables provide an overview of the functions:

Direct functions:

Key	Function	Remark
Menu	Open the OSD menu	
—	Open PIP / PAP settings	
+	Open brightness control	
Exit	Select signal input	
Power	On/ Off	

Navigation in OSD menu:

Key	Function	Remark
Menu	Open sub menu	when in main
	Confirm entry	when in main
Enter	Cursor down	when in main or sub menu
	Cursor/ slider to the left	when in main or sub menu
UP	Cursor up	when in main or sub menu
	Cursor/ slider to the right	when in main or sub menu

Exit	Leave OSD menu	when in main or sub menu
	Leave sub menu	when in sub menu

The green/red LEDs on the external keypad show the current status of the board:

Color	Meaning	Remark
Green	Signal found	
Green blink	Search signal	
Red	Power safe mode	
LED off	Monitor off	

**Special functions of the controller:**

- PIP (Picture in Picture): Simultaneous display of two video sources on the screen with adjustable positions.
- PAP (Picture and Picture): Side-by-side display of two video sources.
- Tiling: Display of a video source on several monitors with mutually non overlapping frames.

**OSD menu**

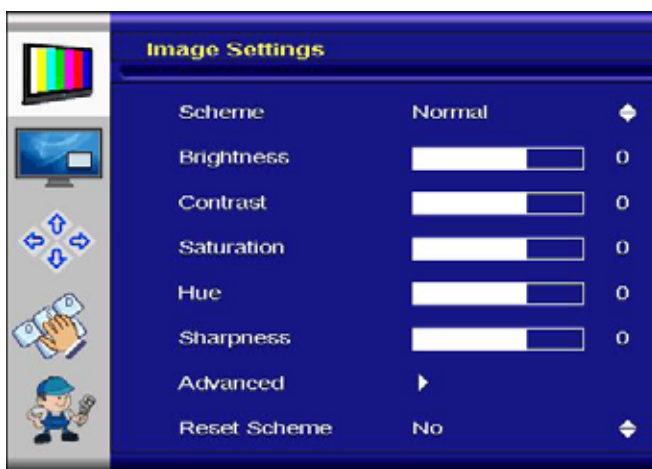

**Image Settings Menu**

- Scheme: Switches between normal/ sport/ game/ cinema/ vivid presets.
- Brightness: Panel brightness adjustment.
- Contrast: Panel contrast adjustment.
- Hue: Panel HUE adjustment (RGB, S-Video and Composite) only.
- Saturation: Panel saturation adjustment (RGB, S-Video and Composite) only.
- Sharpness: Panel sharpness adjustment.
- Advanced: Open Advanced sub menu.



**Advanced Image Settings Menu**

Note: Noise Reduction, Video Processing and Film Mode & Scaling are only available for RGB, S-Video and Composite signals.



**Advanced Color Sub Menu**

- Color Temp:** Allow selection of different color temperature schemes. Selections are user, sRGB, 4200K, 5000K, 5400K, 6500K, 7200K, 9300K.
- User Color:** Create custom color scheme.
- ADC:** Auto Color-Adjust. Performs auto fine tuning on the ADC (RGB, S-Video and Composite only).



**Advanced User Color Sub Menu**

- Red Gain:** Boost adjustment on red.
- Green Gain:** Boost adjustment on green.
- Blue Gain:** Boost adjustment on blue.
- Red Offset:** Offset level on red.
- Green Offset:** Offset level on green.
- Blue Offset:** Offset level on blue.

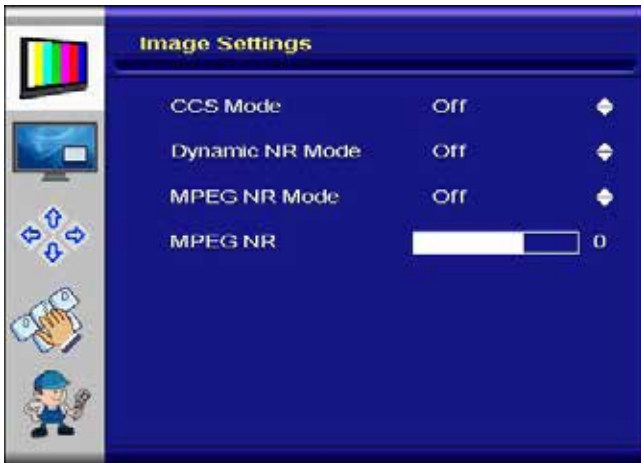

**Advanced Noise Reduction Sub Menu**

- CCS Mode:** Changes Cross-Color Suppression between off/ adaptive/ normal.
- Dynamic NR:** Changes Dynamic Noise Reduction between low/ medium/ high/ off/ adaptive. High setting may cause loss of detail, adjust for best image.
- MPEG NR:** Enables/ disables the MPEG NR Mode.
- MPEG NR:** Manual setting of MPEG noise reduction level.

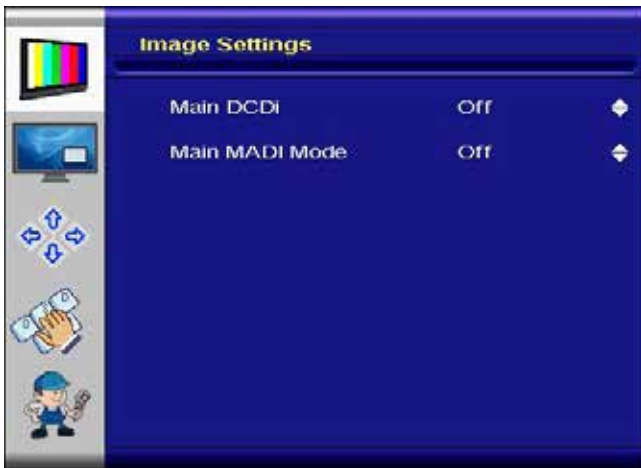

**Advanced Video Processing Sub Menu**

Main DCDi: Turns DCDi on/ off on main channel.  
 MADi Mode: Changes Motion Adaptive De-Interlacing between normal/ off/ adaptive modes.

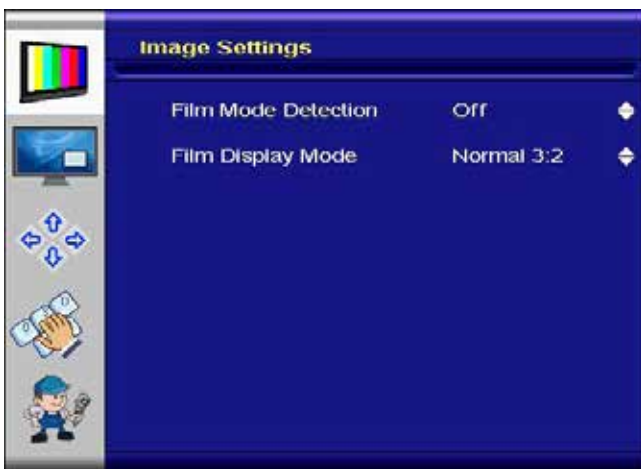

**Advanced Film Mode Sub Menu**

Detection: Selection of Video-3:2/ Video-2:2/ Video-3:2-2:2/ off.  
 Mode: Selection of Normal 3:2 or other future modes.



**Display Settings Menü**

Aspect Ratio: Used to adjust display between full screen, panoramic, Letter Box Expand, Pillar Box and 1:1.  
 PIP: PIP sub menu.  
 Tiling: Tiling sub menu.



**PIP (Picture in Picture) Sub Menu**

- PIP mode: Toggle between Off, PAP-Tall, Side-by-Side, Small PIP and Large PIP.
- Vertical: Vertical position of PIP image.
- Horizontal: Horizontal position of PIP image.
- Transparency: Transparency of PIP image.

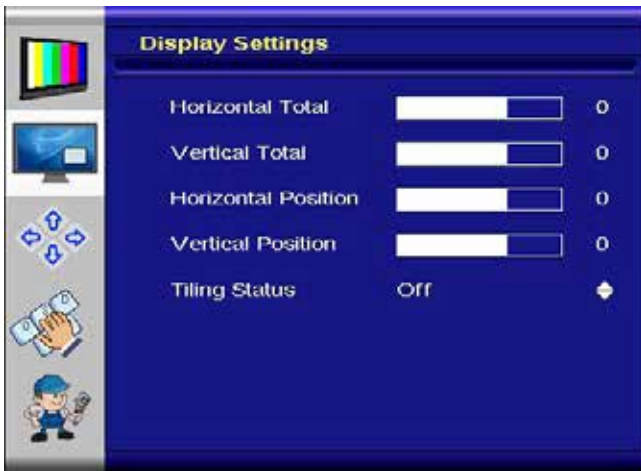

**Tiling Sub Menu (for video walls)**

- Horizontal Total: Defines the total horizontal number of displays.
- Vertical Total: Defines the total vertical number of displays.
- Horizontal Position: Defines the horizontal position of the actual display unit.
- Vertical Position: Defines the vertical position of the actual display unit.
- Tiling Status: Enables/ disables the tiling function. If the PIP-Mode is PAP-Tall or side-by-side, the tiling status will be off and disabled.

Example: 3 by 3 video wall: Definition of Horizontal/Vertical display position:

Position	1	2	3
1	1 / 1	2 / 1	3 / 1
2	1 / 2	2 / 2	3 / 2
3	1 / 3	2 / 3	3 / 3

Note:

- Tiling property cannot be used while PAP-Tall or Side-by-Side modes are active.
- If PIP is turned on, the PIP image would be displayed on every panel of the video wall.
- Image and position menus are disabled while tiling is on.
- For best results, the Horizontal Total and Vertical Total value should to be set to a value which is an integer divider of the input width or height, respectively. For example, if input is 1280x768, horizontal total has to be set to one of 2, 4, 5, 8 and vertical total has to be set to one of 2, 3, 4, 6, 8.



**Position Settings Menu (for DVI, S-Video and Component Video Signals)**

- Width: Adjusts total width of the image by stretching or shrinking.
- Height: Adjusts total height of the image by stretching or shrinking.
- Horizontal Start: Changes the starting point of the image horizontally, without altering height.
- Vertical Start: Changes the starting point of the image vertically, without altering width.



**Position Settings Menu (for RGB)**

- Auto Adjust: Performs auto-adjust function on the image.
- Image Position.: Image position sub menu.
- Phase: Slider to adjust the sampling phase of the analogue interface. For optimum image quality, input pixels should be sampled at the ideal sampling points.
- Clocks/Line: Slider to adjust the sample clock of the analogue interface. This is helpful for improving the image quality for non-standard display modes.
- Advanced: Advanced Settings sub menu.



**Advanced Settings Sub Menu**

- Note: This function can be used to manually force some of the widely used difficult-to-detect modes which can be misinterpreted by the controller.



Advanced Settings Sub Menu (DVI mode only)



**OSD Settings Menu**

- Horizontal: Move the OSD in horizontal direction.
- Vertical: Move the OSD in vertical direction.
- Blend: OSD transparency adjustment.
- Time Out: This function determines after how many seconds the OSD will close itself.
- Horizontal Flip: Flips the OSD horizontally.
- Vertical Flip: Flips the OSD vertically.
- Rotation: Rotates OSD.
- OSD Zoom: Changes OSD size.



**Setup Menu**

- Factory Reset: Execute factory reset.
- Speed Mode: In graphics mode, fast image transfer is supported.
- Show Menu Of: Changes the menu between main image and PIP if the PIP mode is on.
- Input Search: Toggles input search on/ off.
- Auto Brightness: (Optional) Toggles automatic brightness control through external light sensor on/ off.
- Firmware Version: Installed Firmware Version.
- OSD Version: Installed OSD Version.



## 10. POS-Line IQ Intel Celeron



All the Celeron main board drivers you can find at: <https://www.distec.de/en/service/downloads/monitor-downloads/>



Note: This POS-Line display is equipped with a battery. Please read the following note carefully:

- Unplug the power cable before exchanging the battery.
- There is a risk of explosion if the battery is not installed correctly.
- Replace the battery always with a battery of the same type.
- Recycle empty batteries with the free battery collection system. Please read the chapter “Disposal” in this document.

### Passive cooling

POS-Line displays of the IQ Intel Celeron series (integrated PC) are designed for passive cooling.

Passively cooled monitors have a heat pipe that routes by which the heat of the processor to a heat sink on the back of the monitor. Passively cooled devices have no moving parts.

### PC specification

Please inform yourself current data sheet POS Line large about the details of the PC specification of the IQ Intel Core Celeron.

### PC Box

The integrated PC is installed in a separate box which can be removed from the display for maintenance purposes. The PC box must be plugged into the display for operation. The display cannot be operated without PC box.

The power supply for the PC and all other data lines are integrated into the plug-and-socket connection between PC box and display. Additional cables between PC box and display are not required. A dismantled PC, box can be connected to an external power supply and operated separately from the display.

The display module can only be operated via a PC box with an included separate interface for signal transmission (LVDS).

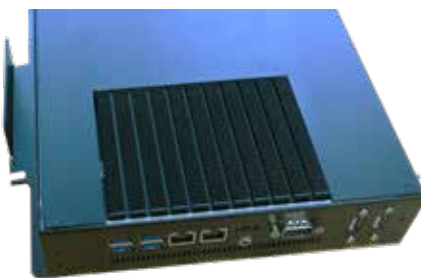

PC box

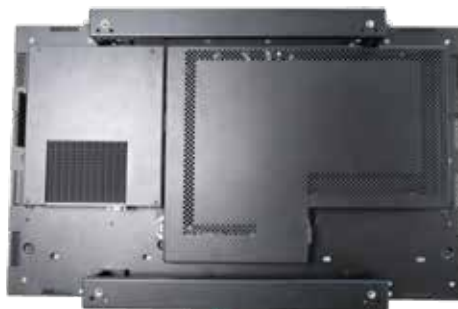

Display with PC box



Interfaces for transmission of the image signal incase of using a display module

## Mounting and dismounting the PC box



Note: The display must be switched off before dismounting or mounting the PC box. Not conforming to the rules may electronically damage the display and the PC box.



Note: The two interfaces on the POS-Line Monitor may only be used for the PC-Box (option). Other uses are not permitted, otherwise they could damage the device.

To remove the PC box please proceed as follows:

- Make sure that the display is completely disconnected from power. Unplug the power cable or switch the monitor off with the main power on/off switch.
- Remove the safety screw (1) from the PC box .
- Pull carefully at the handle of the PC box (2) and lift the PC box from the bolts.

To mount the PC-box please proceed as follows:

- Make sure that the display is completely disconnected from power. Unplug the power cable or switch the monitor off with the main power on/off switch.
- Carefully plug the PC box into the connectors.
- Fasten the PC box with the safety screw.(1).

(1) safety screw

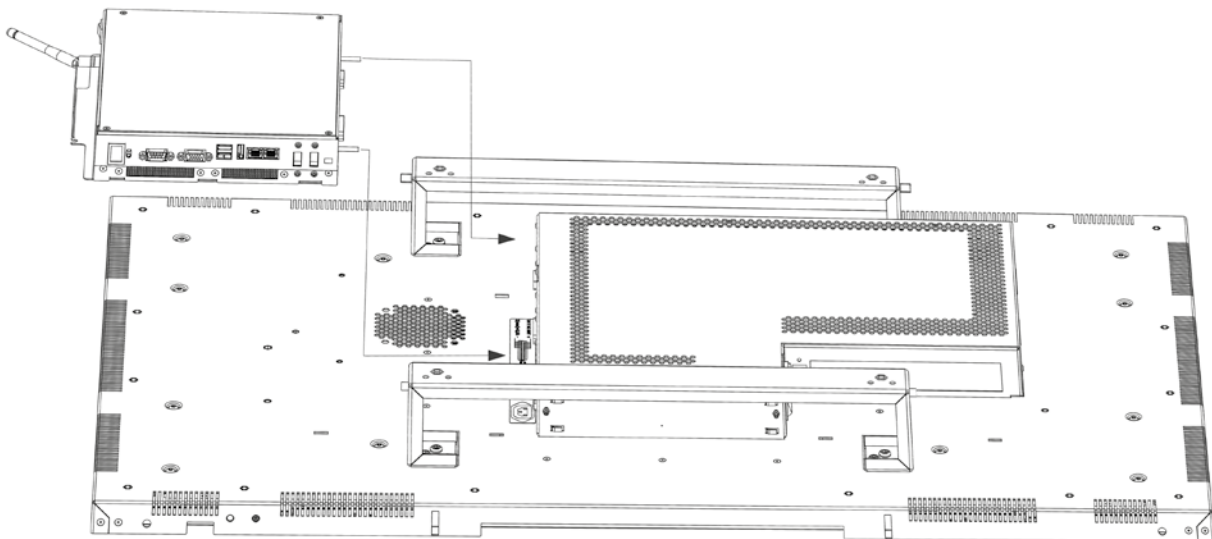
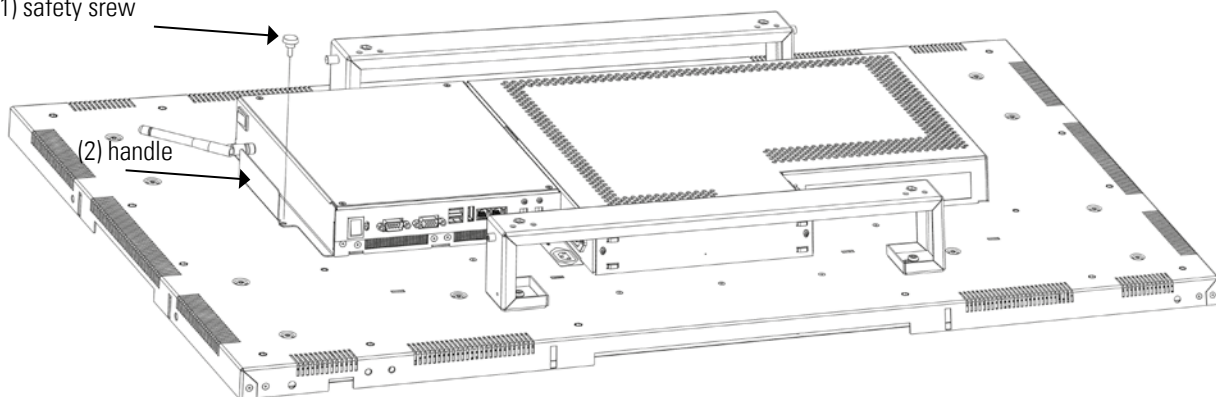

## Operating the PC box without display

The PC box can be operated as stand alone device without display for maintenance purposes. This requires an external power supply with cable (12V DC, 60 Watt) which is available as kit for maintenance (order number DS-91-945).

Please connect monitor, keyboard and mouse before switching on power.

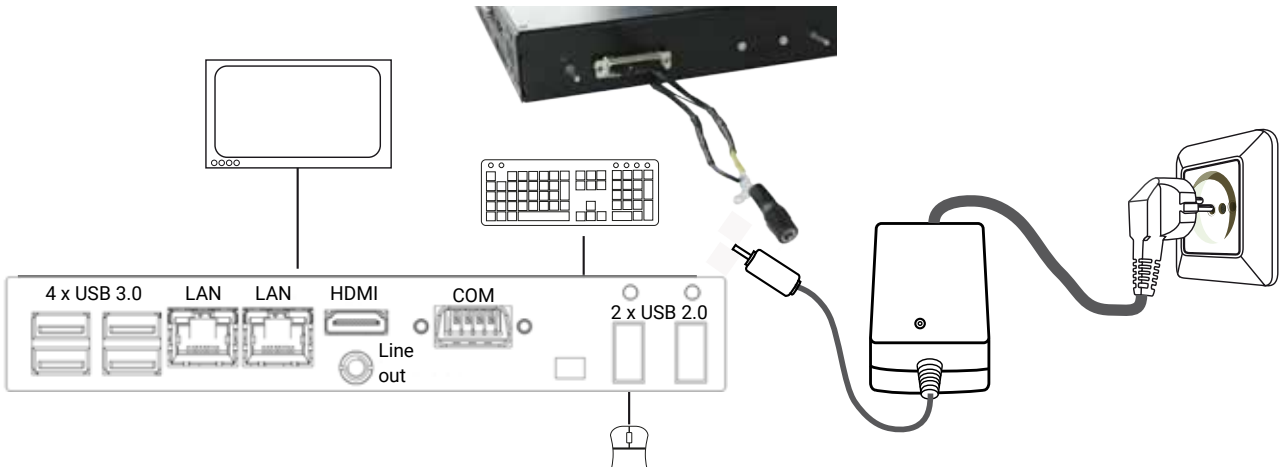

## PC box connectors

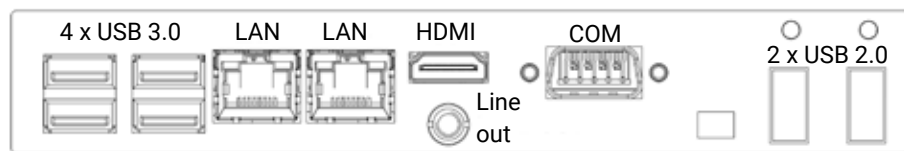

### Connectors of POS-Line IQ Intel Celeron series

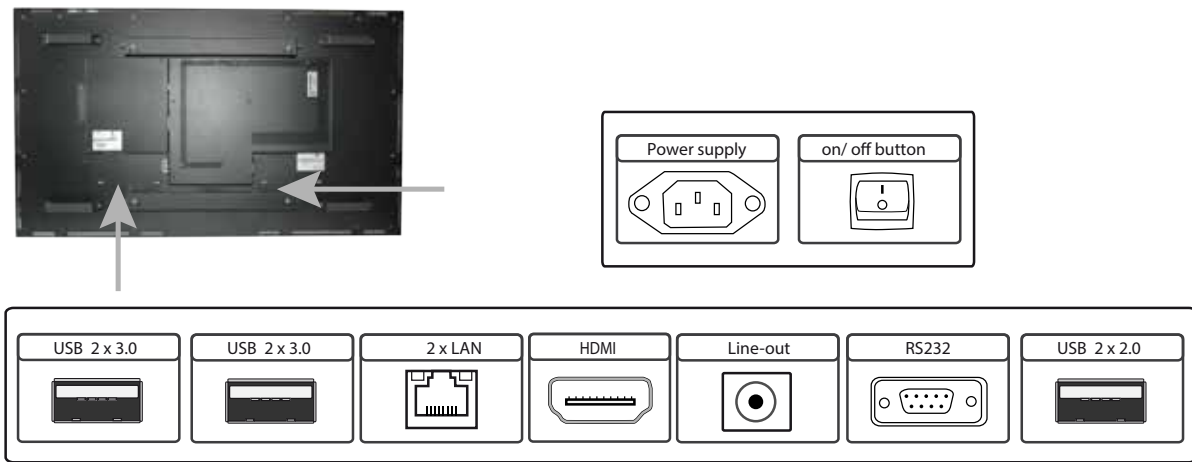

### Connecting to a network using a patch cable

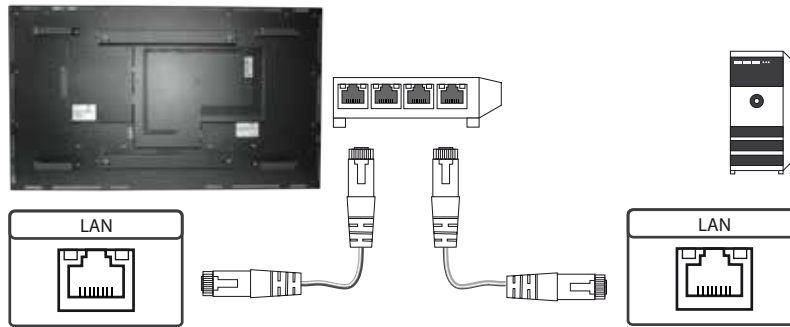

### Connecting to a PC using a cross-over cable

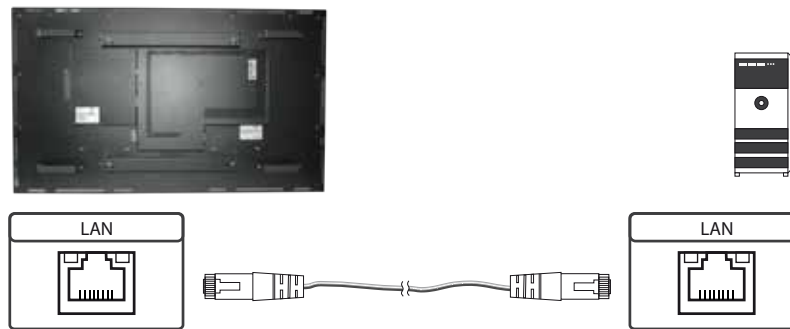

### Connecting keyboard and mouse with USB cable

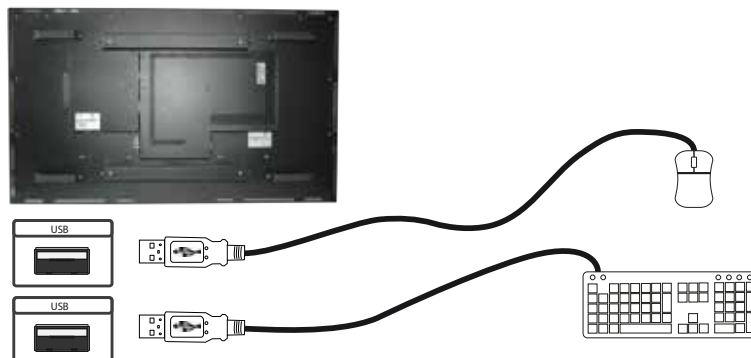

Connecting an external monitor with HDMI cable

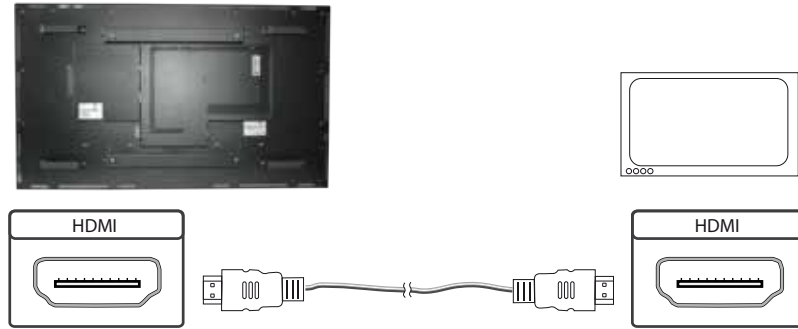

Connecting active speakers with audio cable

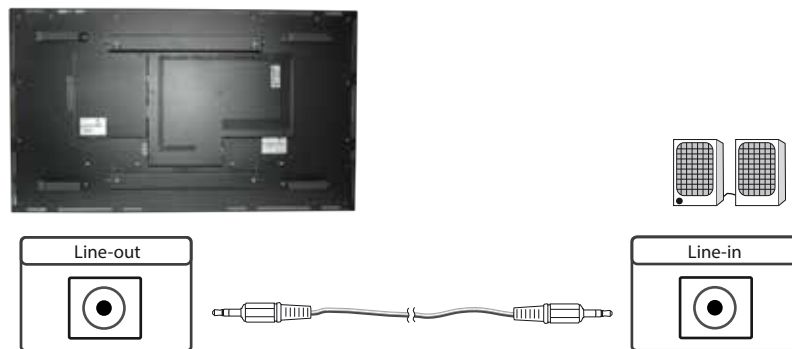

Connecting the Touch to a PC with RS232 cable (for Remote OSD only)

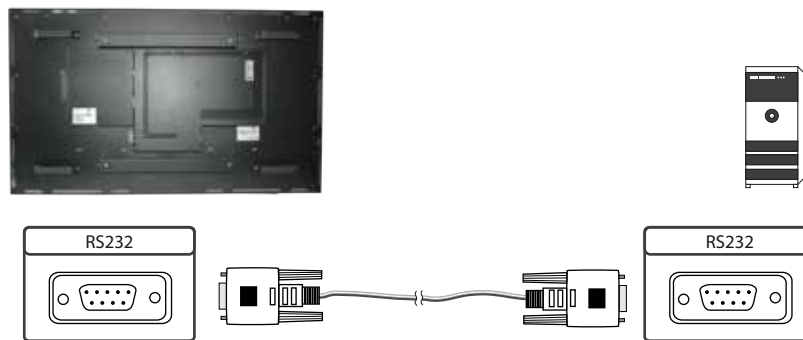

Power on/off

After applying the supply voltage, the PC starts automatically. When the power supply is connected, the PC is switched on or off with the push button. During operation, the PC is shut down by briefly pressing the push button. Briefly pressing the push button switches the PC on.

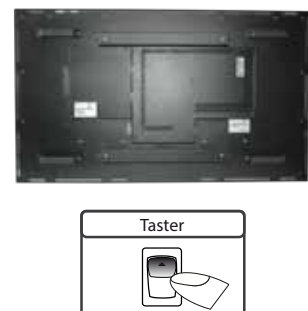

### BIOS settings

A Phoenix UEFI Flash BIOS is installed on the PC main board. To change BIOS settings press the 'Entf' key on your keyboard during the boot process of the PC.

### Operating systems

An operating system is pre-installed if your POS-Line display has been ordered with this option. In this case all main board drivers or touch drivers are installed.

Activating the operating system:

- Windows 10 IoT: This OS is already activated. The license key sticker is located on the back side of the display.
- Windows 10: This OS is not activated. The license key sticker is added to the product documentation. After switching on the display for the first time Windows will prompt for the key

### PC-Box as separately option

The optional POS-Line Celeron Box DS-92-135 does not have a separate interface (LVDS) for image transmission. These PC boxes can only be used in conjunction with the POS-Line Video PIII A devices or POS-Line PME devices. The signal is transmitted via HDMI.

## 11. POS-Line IQ Core™-i5



Note: All the Core™-i5 main board drivers you can find at: <https://www.distec.de/en/service/downloads/monitor-downloads/>



Note: This POS-Line display is equipped with a battery. Please read the following note carefully:

- Unplug the power cable before exchanging the battery.
- There is a risk of explosion if the battery is not installed correctly.
- Replace the battery always with a battery of the same type.
- Recycle empty batteries with the free battery collection system. Please read the chapter “Disposal” in this document.

### Passive cooling

POS-Line displays of the IQ Core™-i5 series (integrated PC) are designed for passive cooling. The device should be mounted with sufficient distance to the wall.

Passively cooled monitors have a heat pipe that routes by which the heat of the processor to a heat sink on the back of the monitor. Passively cooled devices have no moving parts.

### PC specification

Please inform yourself current data sheet POS Line large about the details of the PC specification of the IQ Core™-i5.

### PC Box

The integrated PC is installed in a separate box which can be removed from the display for maintenance purposes. The PC box must be plugged into the display for operation. The display cannot be operated without PC box.

The power supply for the PC and all other data lines are integrated into the plug-and-socket connection between PC box and display. Additional cables between PC box and display are not required. A dismantled PC, box can be connected to an external power supply and operated separately from the display.

The display module can only be operated via a PC box with an included separate interface for signal transmission (LVDS).



PC box



Display with PC box

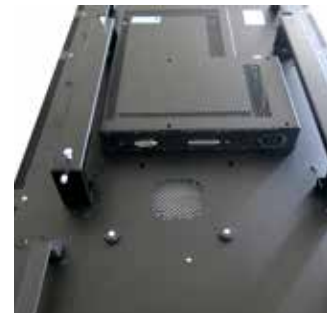

Interfaces for transmission of the image signal incase of using a display module

## Mounting and dismounting the PC box



Note: The display must be switched off before dismounting or mounting the PC box. Not conforming to the rules may electronically damage the display and the PC box.



Note: The two interfaces on the POS-Line Monitor may only be used for the PC-Box (option). Other uses are not permitted, otherwise they could damage the device.

To remove the PC box please proceed as follows:

- Make sure that the display is completely disconnected from power. Unplug the power cable or switch the monitor off with the main power on/off switch.
- Remove the safety screw (1) from the PC box .
- Pull carefully at the handle of the PC box (2) and lift the PC box back away.

To mount the PC-box please proceed as follows:

- Make sure that the display is completely disconnected from power. Unplug the power cable or switch the monitor off with the main power on/off switch.
- Place the PC box on the display module. Make sure that the guide pins on the box dive into the round openings of the display module.
- Slide the PC box inward so that the connectors fully engage.
- Fix the PC box with the locking screw (1).

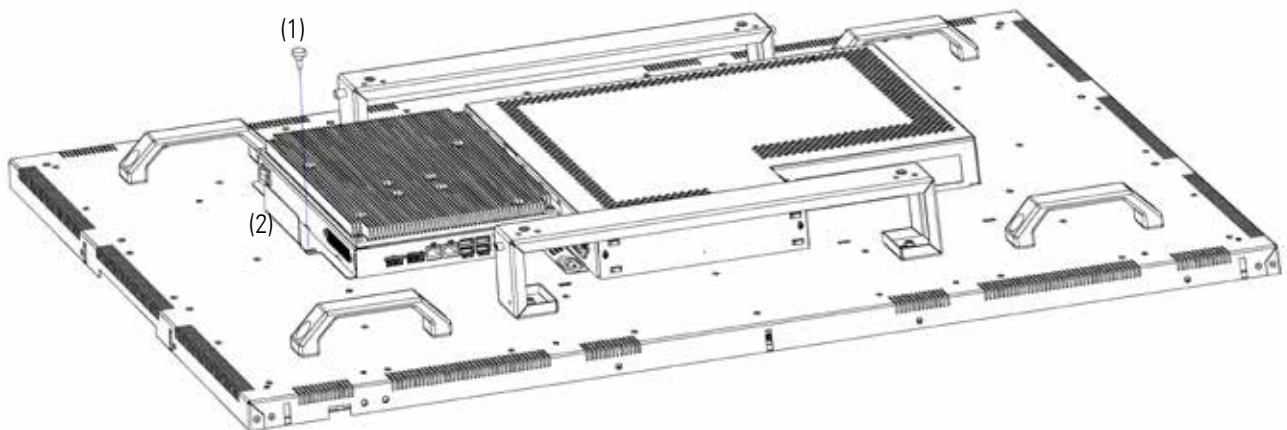



## Operating the PC box without display

The PC box can be operated as stand alone device without display for maintenance purposes. This requires an external power supply (12V DC, 60 Watt) which is available as option (order number DS-91-945).

Please connect monitor, keyboard and mouse before switching on power.

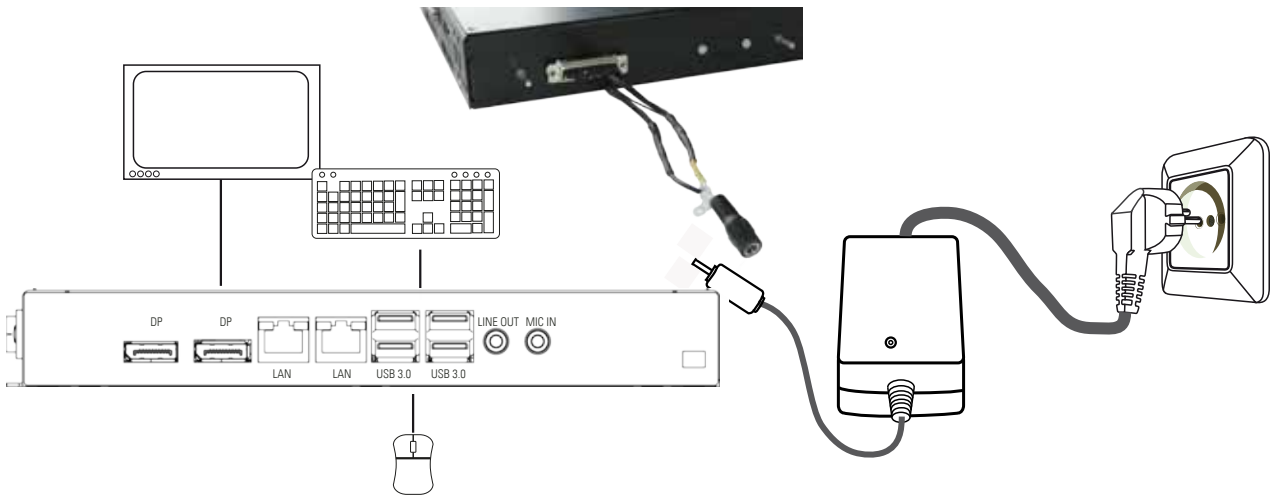

## PC box connectors

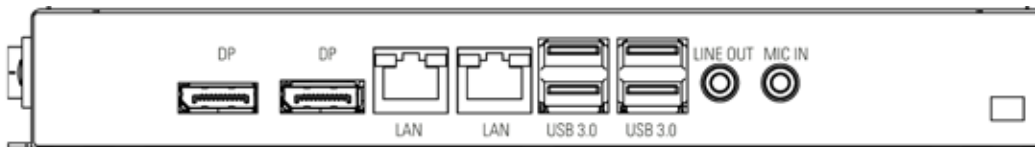

Connectors of POS-Line IQ Core™-i5 series

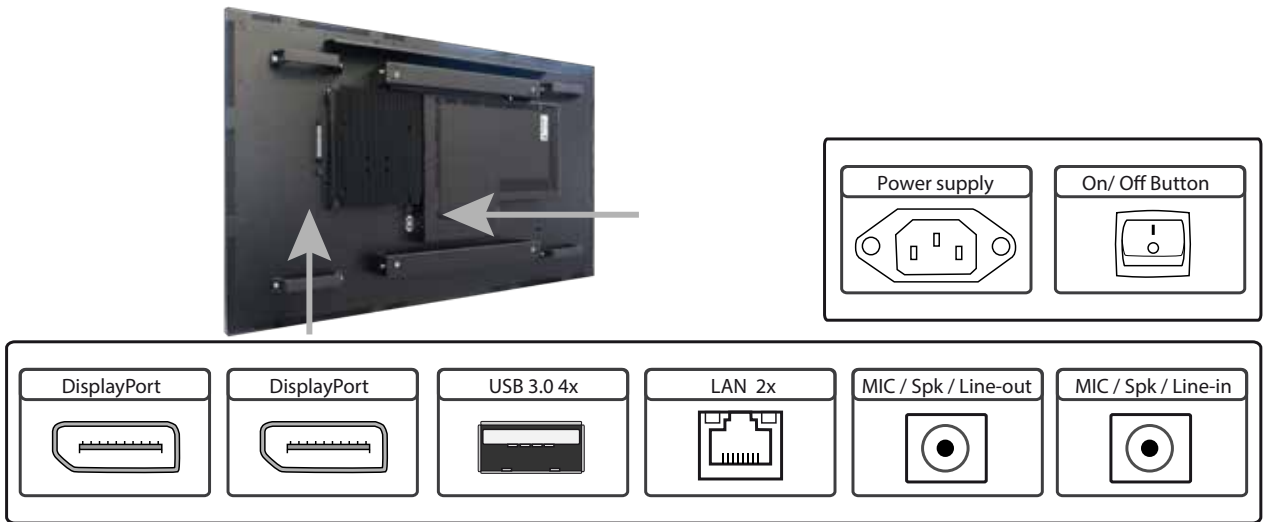

Connecting to a network using a patch cable

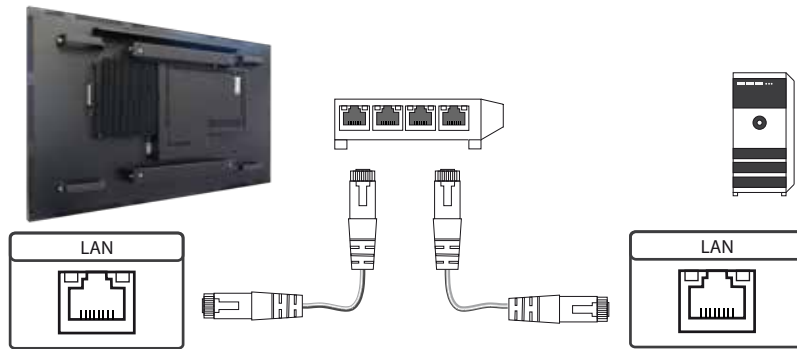

Connecting to a PC using a cross-over cable

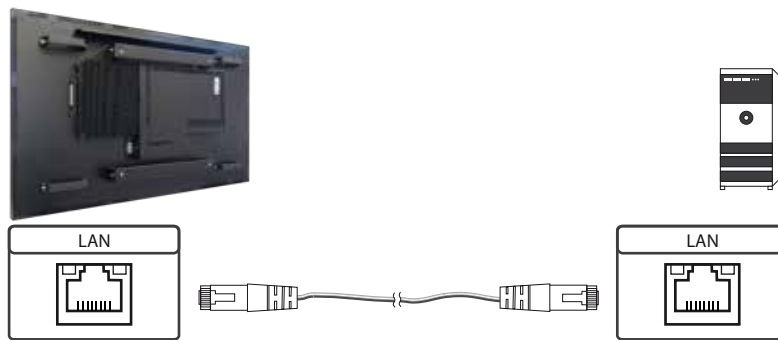

Connecting keyboard and mouse with USB cable

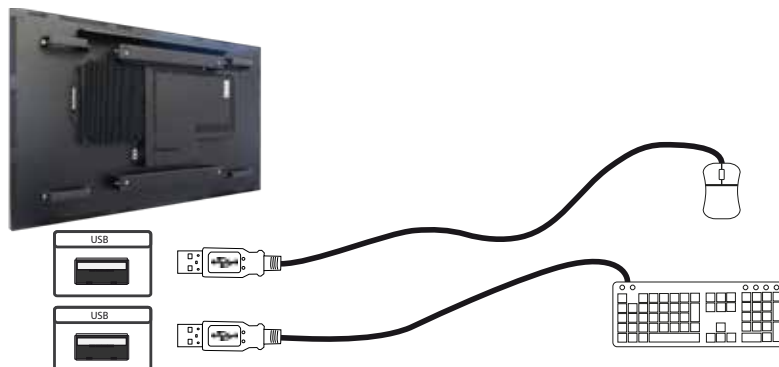

### Connecting an external monitor with DisplayPort cable

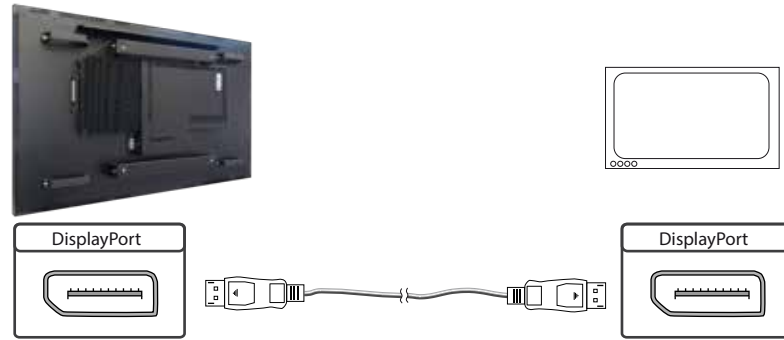

### Connecting active speakers with audio cable

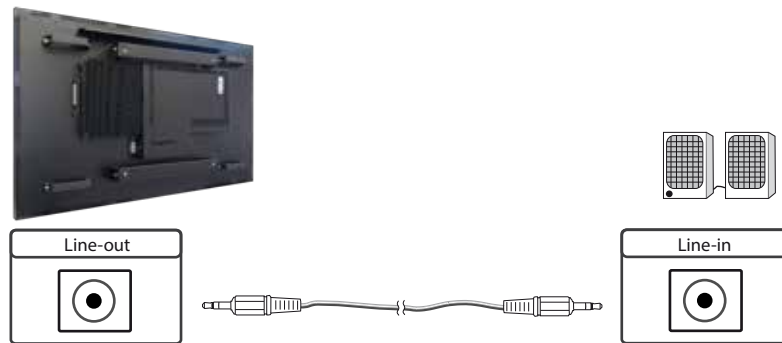

### Power on/off

The display boots automatically after connecting to power. Use the push button to switch the display on and off. If in normal operation, push the push button once to shut down the system into sleep mode. The panel is switched off. If switched off, push the push button once to wake up the display.



### BIOS settings

A Phoenix UEFI Flash BIOS is installed on the PC main board. To change BIOS settings press the 'ENTF/DEL' key on your keyboard during the boot process of the PC.

### Operating systems

An operating system is pre-installed if your POS-Line display IQ Core™-i5 has been ordered with this option. In this case all main board drivers or touch drivers are installed.

Activating the operating system:

- Windows 10 IoT: This OS is already activated. The license key sticker is located on the back side of the display.
- Windows 10: This OS is not activated. The license key sticker is added to the product documentation. After switching on the display for the first time Windows will prompt for the key.

### PC-Box as separately option

The optional POS-Line POS-Line Core-i5 Box DS-92-033 do not have a separate interface (LVDS) for image transmission. These PC boxes can only be used in conjunction with the POS-Line Video PIII A devices or POS-Line PME devices. The signal is transmitted via DisplayPort (KA-40-105).

## 12. POS-Line VideoPoster



Note: Further information on media player, play list structure, handling, utilization and supporting software modules are available at

<https://www.distec.de/en/products/tft-controller/industrial-media-players/>



Note: This Gerhardt display is equipped with a battery. Please read the following information carefully:

- Unplug the power cable before exchanging the battery.
- There is a risk of explosion if the battery is not installed correctly.
- Replace the battery always with a battery of the same type.
- Recycle empty batteries with the free battery collection system. Please read the chapter "Disposal" in this document.

### Connectors of POS-Line VideoPoster series

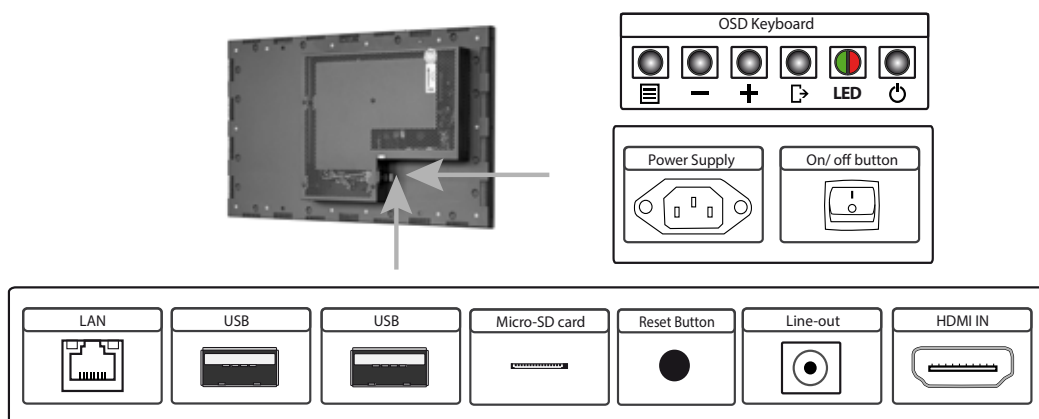

### Connecting to a network using a patch cable

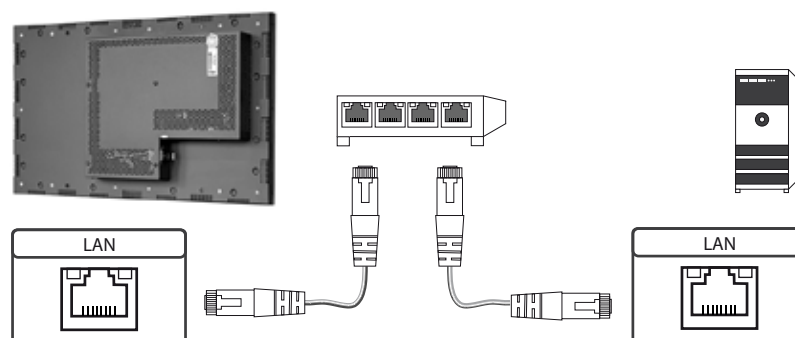

### Connecting to a PC using a cross-over cable

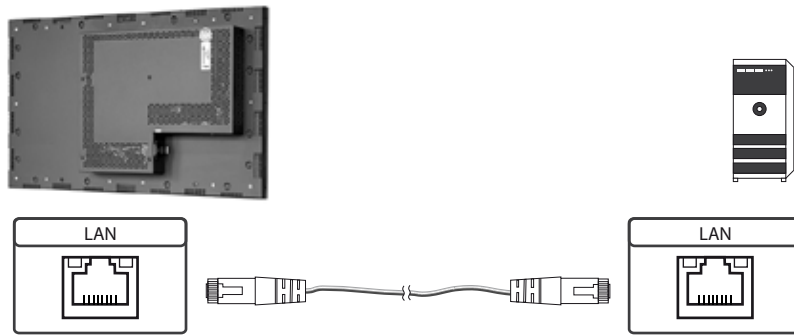

### Connecting an USB stick



### Connecting active speakers

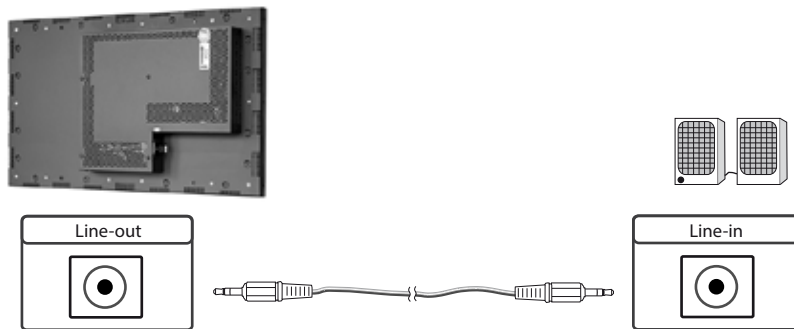

### Connecting a signal source using a HDMI cable

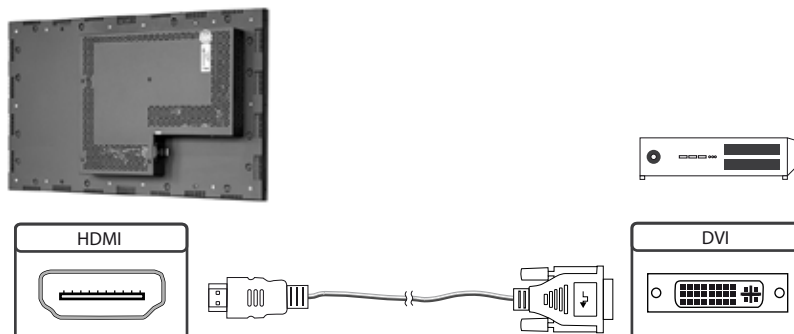

## Connecting a signal source using a HDMI-DVI cable

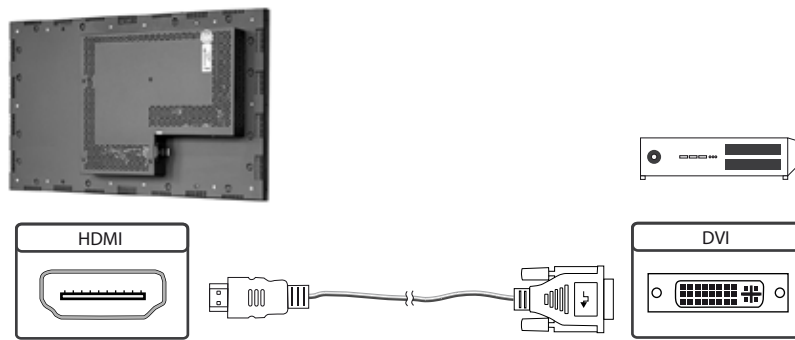

## Factory configuration at the time of delivery

POS-Line VideoPoster is a network (Ethernet) device. Please note that inaccurate network configuration can have unintended influence on network operations and cause a breakdown of the entire network. To setup the device properly, you must be familiar with the basic operating parameters of your network.

Factory configuration of POS-Line VideoPoster at time of delivery:

- DHCP: on
- IP-Address: assigned by DHCP server (fallback to static IP address 192.168.0.1, if no DHCP server is available in the network)
- Netmask: assigned by DHCP server (fallback to 255.255.255.0, if no DHCP server is available in the network)
- Hostname: Videoposter-IV-xx-xx-xx (last 6 bytes of the devices MAC address)
- Login Name: Artista
- Password: Artista
- Content auto update: off

## MicroSD Card

The Mediaplayer stores its playlists on the internal 2GB memory. A microSD card, however, can be extended, if the internal memory is not enough. If a microSD card is plugged in, it must not be removed during operation!

## Supported media formats

Video:

- MPEG-4 AVC / H.264
- Quicktime
- Flash Video
- MPEG Transport Stream

Still images:

- PNG
- JPG
- BMP

## Functional description

POS-Line VideoPoster is a networked stand alone media player to playback play lists. Operating systems or other client-based software components are not required. Play lists are based on a XML structure and can include videos and images. The media player controls the play list. A play list is looped endlessly until a new play list is loaded or the player is switched off. A play list may contain several sub play lists which can be triggered by an internal timer or other external events like push buttons or proximity switches (optional external I/O board).

POS-Line VideoPoster does not need any local operation. As soon as a play list is loaded, the media player will automatically start with playback. Power can be switched off at any time, a shut down procedure is not required. After power on, the media player will automatically playback the current play list.

## Connecting an external source with priority

An external source like video player or sat receiver can be connected to the POS-Line VideoPoster via HDMI. If priority of the HDMI connector has been activated, the playback of the play list will stop as soon as a HDMI signal is detected. In this case, the HDMI signal is shown on the screen. If the external player is switched off, the media player will automatically start or continuing playing back the internally stored play list.

## Software

The following software and accompanying documentation were made available to you by e-mail:

ACC: Windows software to create play lists for POS-Line VideoPoster devices. Use ACC to transfer play lists to VideoPoster, and to store play lists on USB sticks for manual transfer.

ADF: Windows software to support installation and configuration of VideoPoster devices. Connect your VideoPoster as shipped (factory configuration) to the network. ADF will detect all VideoPosters and allow an easy configuration of the network parameters.

## Downloading play lists

There are basically four methods to download play lists:

Via USB: If a USB stick with a playlist is inserted into the Mediaplayer, it is loaded and started automatically. In this operating mode, a network connection is not necessary..

Via ACC: This is a free software for Windows to create play lists and to upload play lists to one or more media player in the network.

Via FTP Server: The media player connects to a FTP server in configurable time intervals and searches for new playlists. The differences between the existing and the new playlist are loaded automatically and playback of the new content starts.

Via HTTP-Protocol: Use HTTP protocol to transfer and control VideoPoster from any existing Content Management System.

## Configuration

Use any Internet browser like Firefox, Internet Explorer, Chrome, etc. for the configuration of the VideoPoster. Enter the URL (i.e. IP address or network device name) to open the device's web interface. Please enter the password if required (factory settings: Login name: Artista; Password: Artista).



## Layout of the web interface:

### Information

System Information:	Here you can find all the information about the system like software revision. In case of a support request please add a printout of this page to your mail for a fast processing.
View Logs:	VideoPoster creates log files to allow an easy monitoring of operations. The following log files are available: <ul style="list-style-type: none"> <li>Player – shows the log file of the video player and error messages.</li> <li>Updater – shows the log file of content updates and error messages.</li> <li>Setup Manager – shows the list of executed setup files.</li> <li>Event Manager – shows error messages of the event manager.</li> </ul>

### Configuration

Network Configuration:	This page includes all entries for the network configuration. Click on „Submit Configuration“ to store the settings and change the configuration. Clicking on „Reset Configuration“ deletes all entries in the web page but does not change the configuration.
Date and Time:	Enter date, time and time zone. Enter a network time server for automatic synchronization (NTP).
Content Auto Update:	To configure automatic content updates with FTP server, enter the FTP server access information and update time interval here.
Audio Settings:	Volume settings for speakers.
Display Settings:	Panel brightness settings.
HTTP Access:	Enter password. It is recommended to change the password after installation.
Advanced:	Firmware updates, microSD card (optinal) formatting, reset of hardware configuration to factory defaults and priority setting for HDMI input.

### Restart

Restart:	Media player restart.
----------	-----------------------

### On-screen display of IP-address and host name

IP-address and host name are shown on the screen for 5 seconds during the boot process.

## 13. POS-Line IoT

The POS-Line IoT monitor is equipped with the Raspberry® Pi compute module 3+ (CM3+). The specification can be found under the following link:

<https://www.raspberrypi.org/products/compute-module-3-plus/>



Note:

The full driver package for the IoT monitor can be found on: <https://www.distec.de/en/service/downloads/artista-iot-downloads/>.

The device is equipped with a battery. Please note the following:

- Disconnect the device from the power supply before replacing the battery.
- If the battery is not replaced properly there is a risk of explosion.
- Always replace the battery with another one of the same type.
- Supply empty batteries to the local waste battery return system. Please also observe the notes in chapter „Disposal“.

### Passive cooling

Monitors of the POS-Line IoT series are equipped with a passive cooling system. Passively cooled monitors divert the heat of the processor to the monitor's housing. Passively cooled devices have no moving parts.

### Spezification

Please refer to the current data sheet for the details of the IoT monitor specification.

### Connectors of POS-Line VideoPoster series

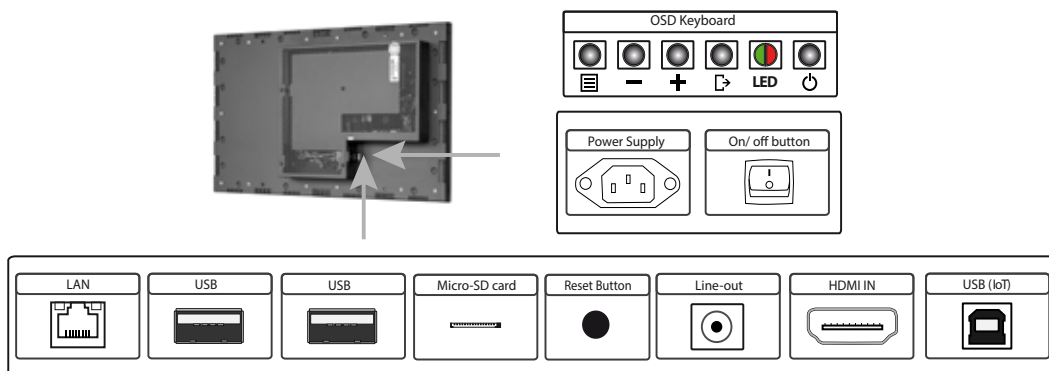

### Connecting to a network using a patch cable

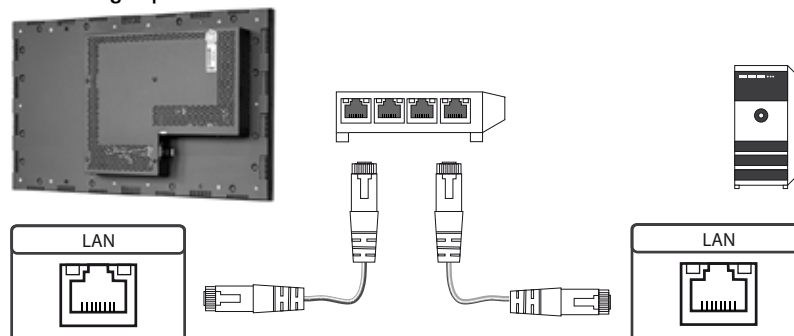

Connecting to a PC using a cross-over cable

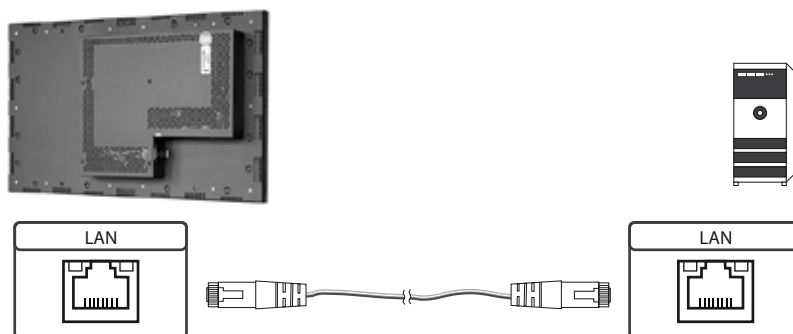

Connecting to an USB stick or keyboard/ mouse



Connecting active speakers

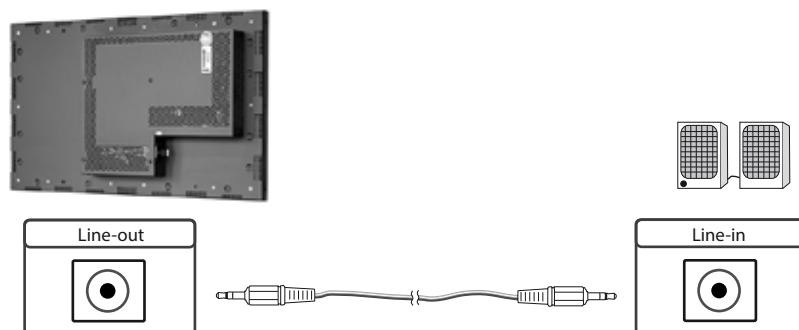

Connecting a signal source using a HDMI cable

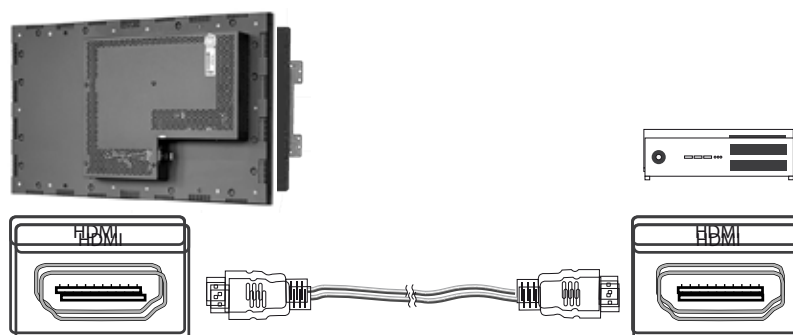

## Connecting a signal source using a HDMI-DVI cable

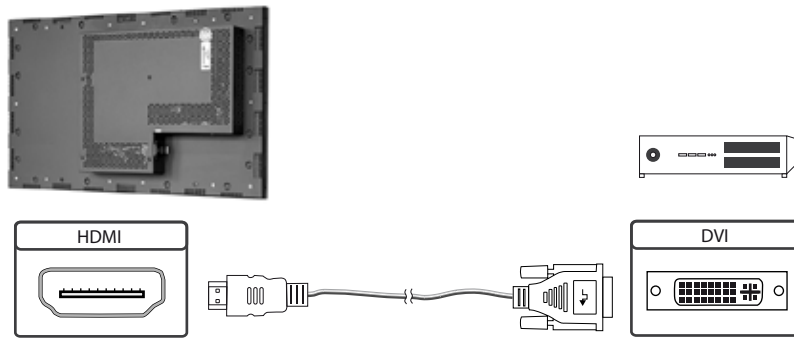

### Switch on/ off

After the supply voltage has been applied, the IoT monitor starts automatically. To switch off, you must select „Shut down“ in the operating system.

### Operating systems

The IoT Monitor comes with the operating system Raspbian, which is equipped with all necessary drivers. This operating system is the official version of the community, reduced to the internal memory of the compute module. It is only used for the first commissioning of the monitors.

The IoT Monitor can be equipped and programmed by the customer with its own operating system/ image. For this, the USB port on the back of the monitor in the connection cover can be used, which is located under the OSD menu.

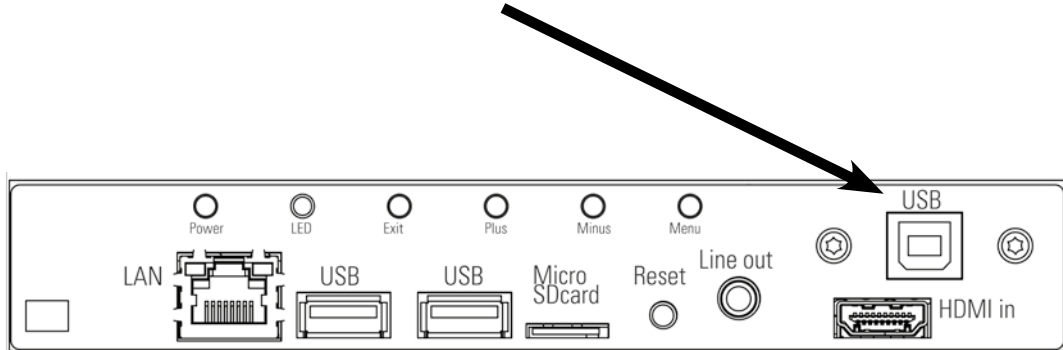

A guide for the integration of an image can be found on our homepage:

<https://www.distec.de/en/products/tft-controller/iot-industry-40-raspberry/>

In the community of Raspberry® Pi (<https://www.raspberrypi.org/forums/>) you can find many problem-solving and help to integrate and create your own system.

## 14. WebPoster

---

### Connections and controls

WebPoster are POS-Line IQ and IOT devices with a special firmware, so the ports and operating in the corresponding chapters must be observed. Connecting a mouse and keyboard is not supported with this firmware.

### Functional description

The Industrial HTML Full HD Player is a complete solution for viewing Web pages. The website can be configured via a web interface. At the start of the device is automatically display.

### Configuration of the media player on delivery (factory configuration)

This device is a LAN (Ethernet) enabled device. Please note that an incorrect network configuration the device may affect the safe operation of the entire network and in the worst case of a network failure leads. To set up the device for a specific network, you need the key operating parameters of the network be known. The POS Line WebPoster is shipped from the factory with the following configuration:

- DHCP: on
- IP-Address: 192.168.0.1\*
- Netmask: 255.255.255.0
- Hostname: WebPoster-xx-xx-xx (the last 6 bytes of the MAC address of the device)
- Login Name: Artista
- Password: Artista

\*If no DHCP server is found, this IP address is assigned automatically.

Supported site formats

- HTML5
- JavaScript

### Software

On our website you will find software and related documentation: <https://www.distec.de/en/service/downloads/webposter-downloads/>.

**ADF:** A program that simplifies the installation and configuration of HTML players. Connect any HTML player in the factory configuration to the network and start ADF. It displays all the HTML players in a list. Select the devices one by one and remove the network configuration.

### Configuration of the media player

The configuration of the HTML player can work with any standard web browser (Firefox, Internet Explorer, Chrome, etc.) are performed. Connect the HTML player to a network and enter to establish the connection URL (eg. as IP address or network name) in the browser. Now open the WEB interface. If you are prompted for the password, enter the password (factory setting: Login name: Artista; password: Artista).

### Layout of the web interface::

#### Configuration

Network Configuration:	The configuration of the network is the first step in setting up.
Submit Configuration:	With Submit Configuration the entries will be accepted.
Discard Changes:	With Discard Changes be deleted entries in the fields. However, this has no influence on the current configuration.
Browser Settings:	The configuration of the Web page to display is the second step of the device. Here the web page can be entered and a „Reload Interval (seconds)“ can be defined.
Submit Configuration:	With Submit Configuration the entries will be accepted.
Discard Changes:	With Discard Changes be deleted entries in the fields.
Change Password:	Here, the default password can be changed.

## Information

System Information: This page contains all details about the system, such as, for example, the software version. If you contact our Support please add this page to your E-Mail to ensure a fast response.

## Restart

Restart: Restart of the media player.

## Display of IP address and hostname

When booting the HTML player's current IP address and the host name of the HTML player is displayed on the screen for about 5 seconds.

## 15. Maintenance

---

Systems with active cooling require cleaning of ventilation slots every 6 months. Systems with passive cooling must be cleaned every 12 months.

## 16. Warranty / Service

---

### Warranty

Distec GmbH grants a manufacturer's warranty of two years from the date of delivery.

The rendering of warranty claims shall neither extend nor restart the warranty period.

During the warranty period, Distec shall repair product faults based on material or production defects. The warranty service is executed at Distec's discretion through repair, replacement of defective parts or by exchanging a product for a product of equal quality without charging the customer for material or labor.

Warranty claims are only accepted, if Distec receives notification of a defective product within the warranty period and the product is presented to the Distec Service Centre together with all information as specified in the RMA process.

### Warranty Exclusions and Limitations

This warranty does not apply to any defect for which Distec is not responsible and which includes, but is not limited to the following:

- Unauthorized opening or disassembling of the product
- Faulty maintenance by non-observation of maintenance instructions
- Inappropriate storage or cleaning of the product
- Unauthorized modification of the product
- Incorrect use or misuse
- Non-observation of operating and installation instructions
- Permanent display of fixed images (causing image retention or image sticking)
- Operating the product in conditions which exceed the limitations of the specification
- Use of inappropriate boxes, packaging or modes of shipment
- Force majeure like fire, acts of war, acts of violence, chemical or biological impacts, lightning strikes, over voltage or similar events
- Fault resulting from the use of software which was not originally supplied with the product or which is incorrectly installed
- Normal wear and tear and wearing parts (i.e. LCD panel)

Mechanical damages like scratches, pressure or break points are excluded from this warranty.

This warranty does not include accessory parts which are not integral part of the product (as boxes, batteries).

Pixel errors only constitute a fault under the terms of this warranty if they deviate from the product specification (i.e. ISO 9241-307 pixel failure class II).

### Display Quality - Prevention of after image burn in effects

After image burn-in means that an image or part of an image (i.e. logo) remains visible on the screen even if the image on the screen is changed. This should not occur if the LCD panel is operated in normal conditions with changing content. To prevent burn-in effects please follow the following guidelines.

- Do not display fixed patterns for an extended time period of more than 12 hours.
- Power-off the monitor for 4 hours after using it for 20 hours, and for 2 hours after using it for 12 hours.
- Use the power scheme and power management of the PC.
- Use plain-colored screen savers.
- Avoid patterns with a strong difference in brightness and contrast.
- Avoid gray colors.
- Change images and logos regularly. Show animated pictures for 60 seconds after 4 hours of operation.
- The best way to protect your display is to switch the monitor off when not in use or to use screen savers.

Non-observance of these guidelines may have effects on warranty.

### Warranty Processing

Group RMA process. In order to avoid unnecessary charges, it is important to adhere to the RMA regulations.

Products must be appropriately and professionally packed for a safe return to the Distec Service Centre. Products with panel sizes equal or larger than 81 cm (32") must be shipped on pallets in upright position.

Distec does not assume liability for any customer data stored on products which are returned to Distec.

### Limitations of Liability and Benefits

With this warranty declaration, Distec exclusively warrants that the product is free of material and manufacturing faults.

Distec does not issue any other warranty or similar statements other than this declaration.

This warranty does not impair or affect a buyer's statutory claim against the seller due to material damage. Such claims can be asserted instead of the warranty agreed to here at the buyer's discretion.

Mandatory legal rights and mandatory claims under the German product liability remain unaffected.

### Applicable Law and Place of Jurisdiction

The laws of the Federal Republic of Germany apply.

Place of jurisdiction is Munich.



## Service addresses

### Germany

Distec GmbH - Werk Kindel  
 Am Künkelhof 4  
 99820 Hörselberg-Hainich  
 ☎ +49 3 69 20 71 62-0  
 ✉ support@distec.de

### Great Britain

Display Technology Ltd.  
 Osprey House, 1 Osprey Court  
 Hichingbrooke Business Park  
 Huntingdon, Cambridgeshire, PE29 6FN  
 ☎ +44 14 80 41 16 00  
 ✉ info@displaytechnology.co.uk

### USA

Apollo Corp.  
 87 Raynor Avenue, Unit 1  
 Ronkonkoma NY 11779  
 ☎ +1 63 15 80-43 60  
 ✉ info@apolloDisplays.com

Please go to the following web address for further information about our RMA regulations and RMA forms:

[Http://www.distec.de/en/service](http://www.distec.de/en/service)

## 17. Disposal

### Disposal of old devices

If the acquired Distec product is to be disposed of, must be implemented into national law the Directive 2012/19/EU.



### Disposal of batteries

Applicable in all countries of the EU and in countries with separate battery collection systems.

The Batteries in this product should not be disposed with other household waste. The chemical symbol Pb, Cd or Hg indicate that the battery contains lead, cadmium or mercury above the reference level in EC directive 2006/66/EG.

Batteries which are not disposed correctly can cause harm environment and health.

Our environment is close to our hearts. Please help us to protect our environment and recycle empty batteries with the free battery collection system.



### 18. Declaration of Conformity

---

#### Declaration

Hereby the Distec GmbH declared that the unit EU is in compliance with the essential requirements and other relevant provisions of Directives 2014/30/EU and 2014/35/EU and 2011/65/EU.

If you need a CE declaration of conformity, please request it from support on our website: <https://www.distec.de/en/service/technical-support/>.

#### FCC-Declaration of conformity

This equipment has been tested and found to comply with the limits for a Class A digital device, pursuant to Part 15 of the FCC Rules. These limits are designed to provide reasonable protection against harmful interference when the equipment is operated in a commercial environment. This equipment generates, uses and can radiate radio frequency energy and, if not installed and used in accordance with the instruction manual, may cause harmful interference to radio communications. Operation of this equipment in a residential area is likely to cause harmful interference in which case the user will be required to correct the interference at his own expense.

#### Canadian Department of Communications Compliance Statement

This Class A digital apparatus meets all requirements of the Canadian Interference-Causing Equipment Regulations.

Observation des normes-Class A - Cet appareil numérique de la classe B est conforme à la norme NMB-003 du Canada.

#### FCC Information:

- Changes or modifications not expressly approved by Distec GmbH could void the user's authority to operate the equipment.
- Use the attached specified cables with the POS-Line monitor so as not to interfere with radio and television reception.
- Please use the supplied power cord or equivalent to ensure FCC compliance.
- Please use the supplied shielded video signal cable, Mini D-SUB 15 pin to Mini D-SUB.