

USER MANUAL

Brilan 4K series



Brilan 4K monitors



Copyright

The contents of this manual are subject to change without notice.

© 2021 Distec GmbH. All rights reserved.

Reproduction of this manual in parts or entirely without the previous authorization of Distec GmbH is prohibited.

Distec GmbH is not liable for errors and collateral or subsequent damage which result from supply, deployment or any other utilisation of this document.

All product names mentioned in this document are trademarks or registered trademarks of their due owners.

Table of contents

1. General specification.....	4
2. Scope of delivery	4
3. General Safety Regulations	5
4. First Installation.....	8
5. Instruction sheet wall mount	10
6. Brilan 4K monitor controller	12
7. Rock PI4 module B (option).....	26
8. External PC box IQ Core™-i5.....	28
9. Touch Sensors.....	31
10. Maintenance	34
11. Warranty / Service	34
12. Disposal.....	36
13. Declaration of Conformity	37

1. General specification

Scope of Document

This user manual is valid for Video wall monitors 109.2 cm (42.5") up to 217.4 cm (85.6").

Important note: This user manual is complemented by other additional documents when indicated.

All documents are also available for download from Distec GmbH web site: www.distec.de/en.

Brilan 4K variants:

Monitor with integrated controller, 2 x HDMI (in), 1 x HDMI (out), 1 x Display Port in, 1 x RS232 (in & out), IR sensor, USB for download.

2. Scope of delivery

When unpacking the monitor, please check if the following accessories are included in the shipment:



Note: Pictures can differ from actually supplied products.

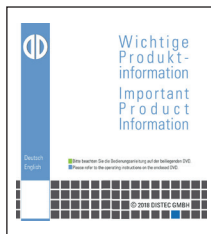

Product information

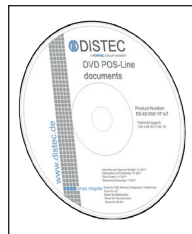

Accompanying-DVD (Manuals, Datasheets, Driver, Drawings)



Power cable



HDMI cable



remote control



USB cable for touchscreen*

only for 42.5"/ 54.6"/ 64.5"/ 85.6" with option touchscreen

3. General Safety Regulations

Safety information

Please read this safety information carefully for your personal safety and for the prevention of property damage.

In case of a malfunction, immediately disconnect the power plug and contact your dealer or the next Distec GmbH service centre. A malfunction is also considered if the housing, a control element or cable is damaged or if liquids or other objects penetrate the monitor.

Please read the safety information carefully before installing the device. If you have any doubts about whether the device may be used in a particular environment, please contact our service partner.

Repairs

Repairs may only be carried out by authorized technical personnel. Unauthorized access or improper repairs might cause serious property damage or cause danger to the user. In addition to that, any legitimate warranty claim expires.

Electrical connection

Disconnect the monitor from socket before executing any work. Do not touch or connect data cables or power cables during thunderstorms.

System start-up

Before the system start-up let the monitor adjust to the room temperature. Do not expose the device to direct heat sources. In case of condensation, please wait a minimum of 12 hours before switching on the monitor. The monitor shall only be installed and used according to this documentation data sheets. Only qualified personnel may perform the initial installation and system setup.

Qualified personnel

Qualified personnel, in terms of the safety information of this documentation, are persons who are qualified to activate, ground and label devices, systems and circuits according to the safety standards.

Operation

For a proper and safe utilization of the product, adequate transportation, storage, installation, assembly, careful handling and maintenance are essential. The device is only certified for in-door operation. Extreme ambient conditions shall be avoided and the monitor shall be protected from dust, humidity and heat. Do not expose the monitor to direct sunlight.

Transport

Unpack the monitor at the place of installation. Use only original packaging for transportation. Please observe these rules for any later transport.

Condensation

Avoid condensation during transport at low temperatures or at extreme fluctuations of temperature.



Safety guidelines for the handling of LCD monitors

- If the device is not used for a long period of time, unplug the power cable.
- Do not unplug the power cable while the device is powered on, except for emergencies.
- To unplug the device without problems, sockets have to be easily accessible.
- Ensure that the power cable does not get pinched or kinked.
- Do not place heavy objects on the power cable.

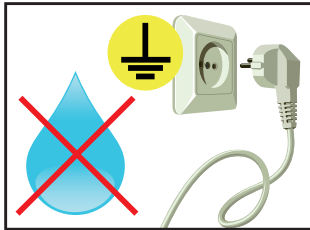

- Do not use damaged or loose sockets to plug in the device.
- Plug the device in earthed sockets only.
- Operate the device with the power cables included in the delivery packet only.
- Use undamaged power cables only.
- When plugging in and out, do not touch the power cable with wet hands.
- Ensure that the power cable is plugged in the socket safely and correctly.
- Use for devices with external power supply only the supplied original power supply, or an equivalent Low Power Source (LPS).

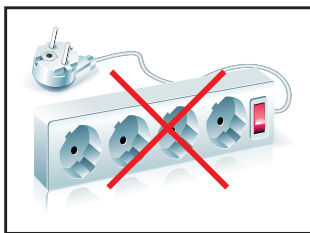

- Do not use extension block to plug several devices into a single socket.



- According to the size, devices may be difficult to handle and very heavy. Ensure that at least two people lift and carry the device.
- Put down the device slowly and carefully to avoid damaging the LCD screen. Ensure that the device stands stable.
- Keep packaging away from children. Danger of suffocation!
- Use our specified and professionally mounted wall mounting only.



- Do not put objects onto the device.
- Do not place candles, heaters or humidifier near the device.
- Keep the device away from fireplaces and flammable materials.

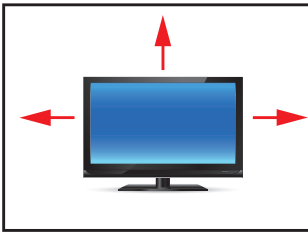

- Ensure sufficient ventilation of the device.
- Keep a minimum distance of at least 10 mm devices to the wall, for devices with integrated PC of at least 40 mm.
- Ensure compliance with the operating temperature.

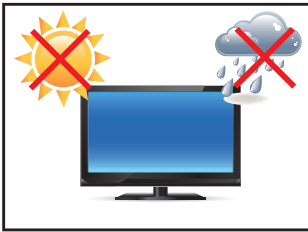

- Do not install the device in places where it is exposed to environmental impacts such as rain or direct sunlight.
- Do not install the device in places where it is exposed to high humidity, dust or smoke. In case of doubt, please contact your sales partner.



- Please use a soft, moist cloth for cleaning.
- For cleaning the screen, please use only commercially available screen cleaner. Do not spray the cleaner directly to the device but onto a cloth.
- Please clean ventilation slots regularly to ensure a good air circulation.

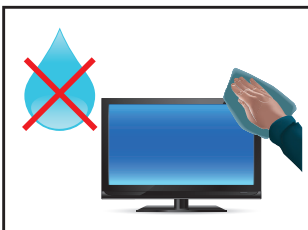

- Protect your device from water splash.
- When cleaning, please make sure that no liquids get into the device.
- Screens and surfaces can be easily scratched. Therefore, please use the prescribed cloth only.



- Attention! High voltage! Never open the device by yourself.
- In case of unusual noises, burnt smell or smoke unplug the power cable.
- Do not insert objects into the device through the ventilation slots.
- If the same picture is displayed over a longer period of time, an after-image may arise.
- When exchanging batteries of the remote control, pay attention to the polarity. Keep batteries away from children and ensure an environmentally correct disposal.

4. First Installation

Position of connectors and controls

All connectors for power and cables are located at the bottom of the back side of the display.



Mounting

Distance to wall:

- devices without integrated PC: min. 10 mm
- devices with integrated PC: min. 40 mm

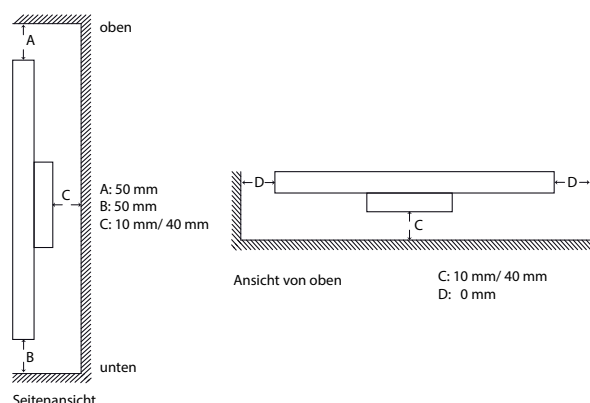

Mounting with VESA compatible brackets

Brilan 4K displays are shipped with factory installed with VESA compatible mounting holes. The monitor can be mounted with every VESA compatible wall mount, whose load capacity matches the weight of the monitor. For mounting must be used 4 metal screws M6 for 42.5", 54.6", 64.5" and M8 for 74.5" and 85.6".

In addition, we offer a wall mount especially for these monitors. (Chapter Installation Instruction wall mount)

The operating position of the device is perpendicular (90 degrees to the floor). Pay attention to the permissible tilt angle for wall mounting. The device can be operated both in landscape mode and in portrait mode, 85.6" only in landscape mode. The information for positioning is noted on the back of the device, always.



VESA standards 42.5"/ 54.6"/ 64.5": MIS-F 400 x 400 mm (M6)

VESA standards 74.5": MIS-F 800 x 400 mm (M8)

VESA standards 85.6": MIS-F 600 x 400 mm (M8)



Allowed tilt angle for mounting

Attention! All monitors are not allowed to be mounted with a tilt angle of 0°.

Connecting to power

The Brilan 4K monitor requires an AC voltage of 100-240 V AC. The standard delivery includes a suitable power cable for connecting the power supply.

Please pay attention that there is a suitable socket near the device, as a disconnecting device.



Note: Install all data cables to external devices before connecting the display to power.

- Switch the on/of switch in position off.
- Connect the power cable to the display.
- Connect the power cable to a power socket.
- Switch the display on .

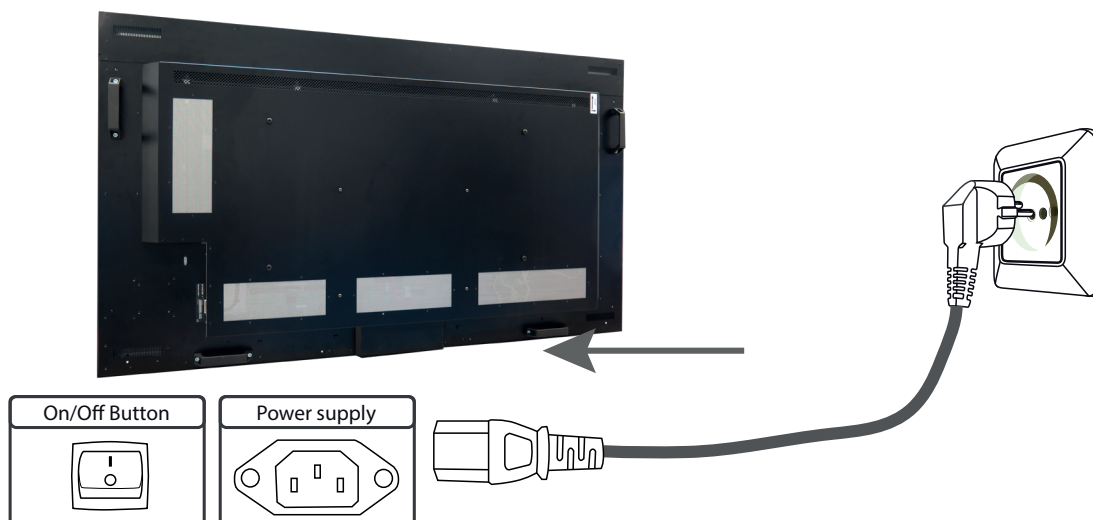

Infrared sensor

The IR sensor is located in the lower area of the back of the monitor (42.5" - 74.5"). Due to the reflections on the wall, settings of the monitor can be made with the remote control.

With the 85.6" monitor, the sensor is located behind the panel; direct alignment of the remote control with the monitor is also sufficient here.

5. Instruction sheet wall mount

A special wall mount is available for sizes 42.5" to 64.5". This wall mount enables a very flat and rigid suspension without inclination on a wall. The retaining lugs of the wall mount fit into the back cover of the monitor both in landscape and in portrait mode.

LANDSCAPE

PORTRAIT

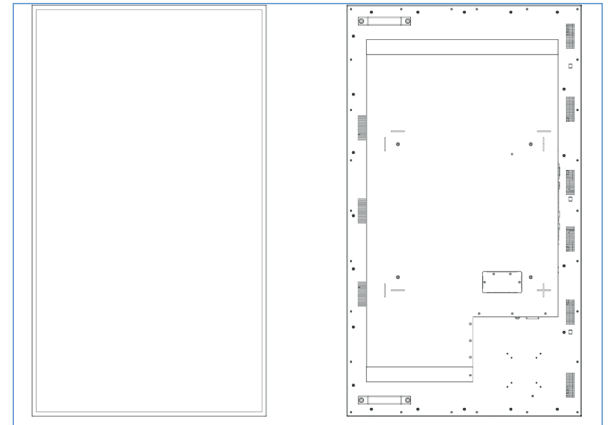
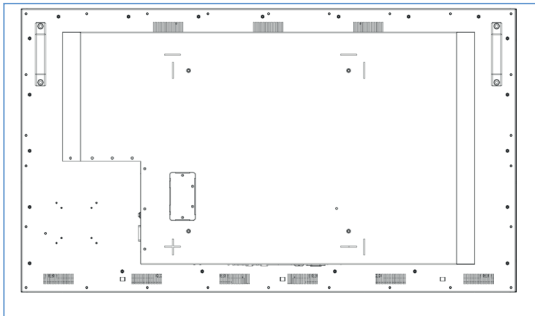

1. Installation of wall mount/ Monitor center after assembly

For easy installation, the later middle of the monitor is marked by a spot on the wall mount. For correct installation, the arrow at the wall mount must show upwards.

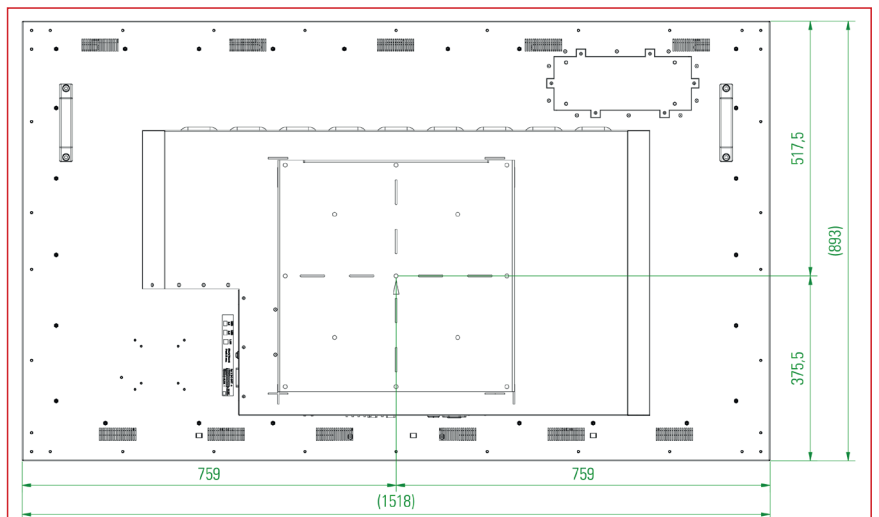
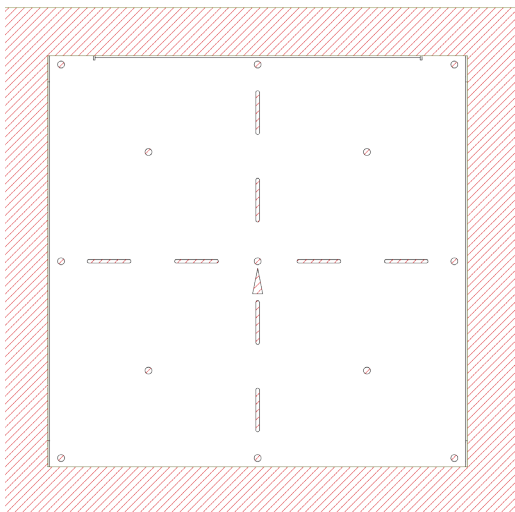

CAUTION! With the 65" monitor, the center of the wall mount is NOT on the center of the monitor in either orientation. Please note the dimensions above.

2. Hang up the monitor into the wall mount

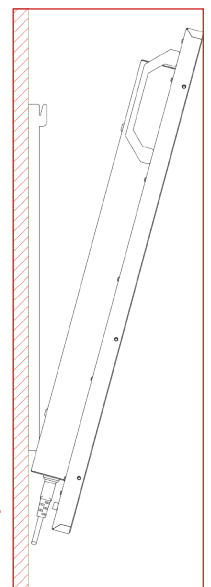
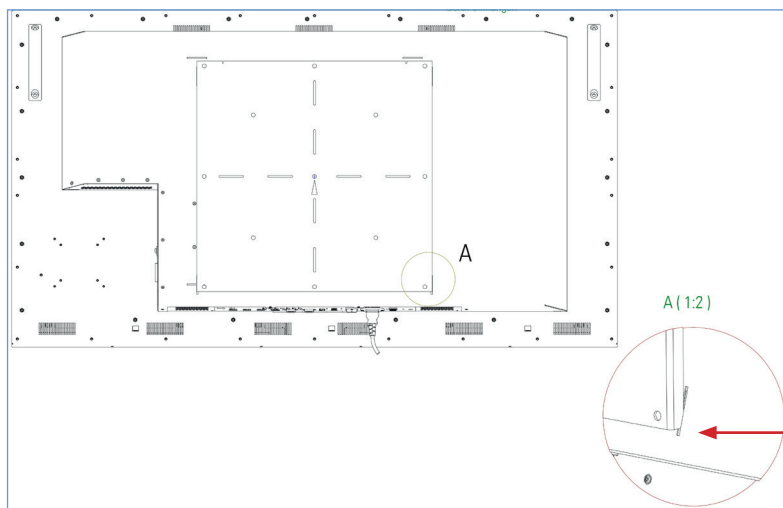

3. Tilt the monitor to the wall mount

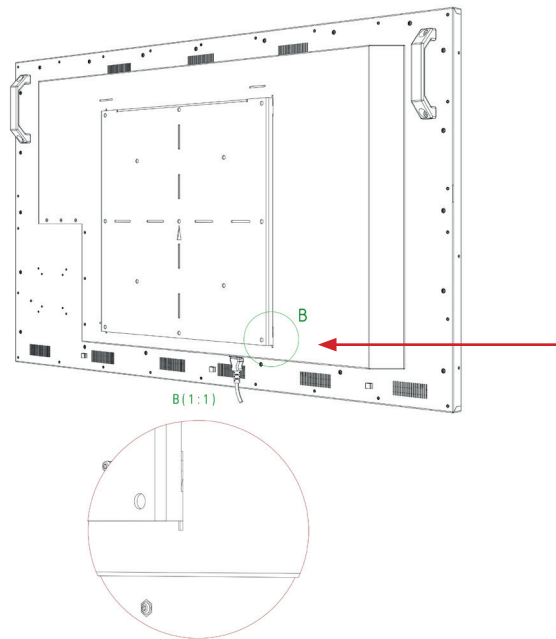

4. Slide the monitor down

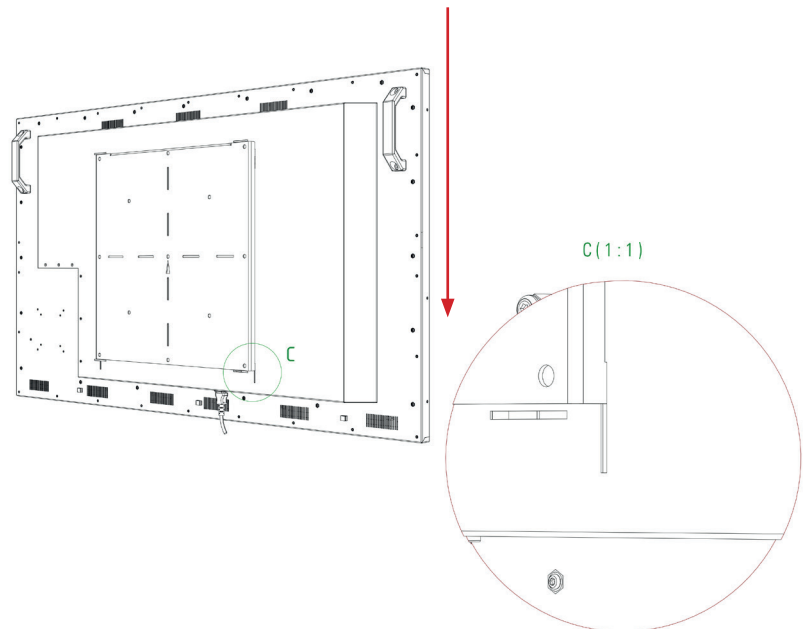

6. Brilan 4K monitor controller

Brilan 4K Monitors have the following connections and controls:

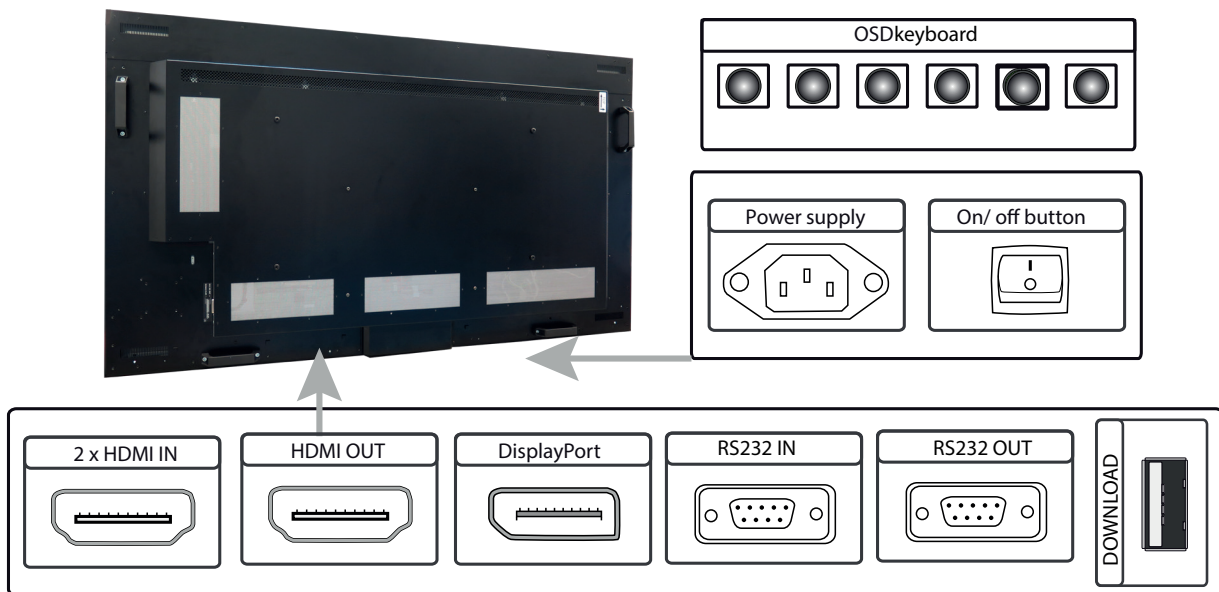

Connect to a PC or an external device with HDMI cable

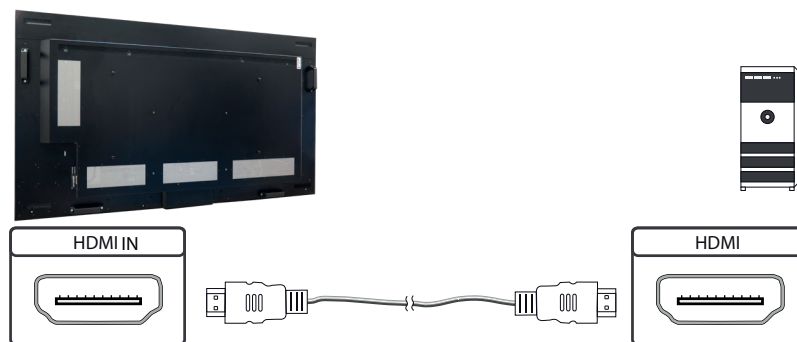

Connect to a monitor with HDMI cable

In order to be able to display the image of Monitor 1 on another monitor, the signal source coming from the PC must be connected to Monitor 1 connected to HDMI IN 1. When using the display port output, there is no signal passing to HDMI OUT.

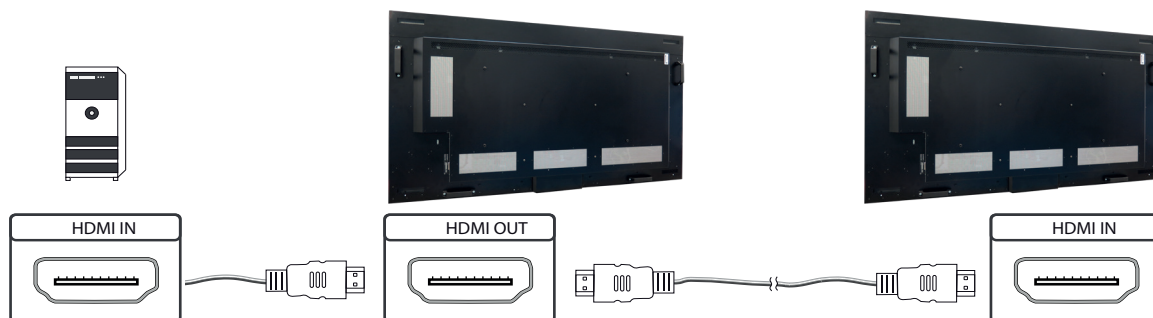

Connect to a PC with DisplayPort cable

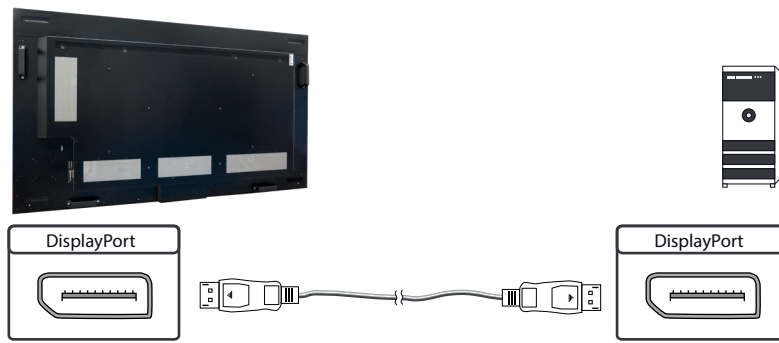

Connect to a PC or an external device via RS232

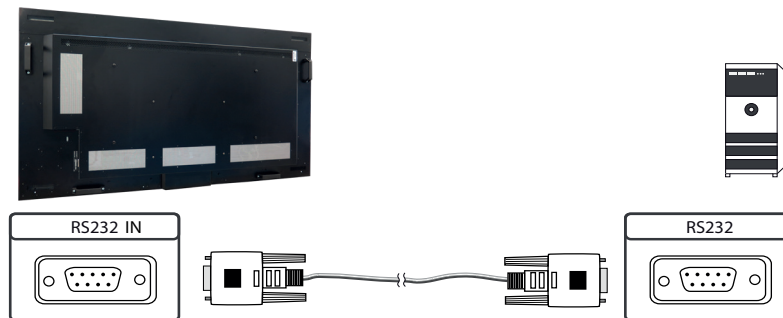

Connect to a monitor with RS232 cable

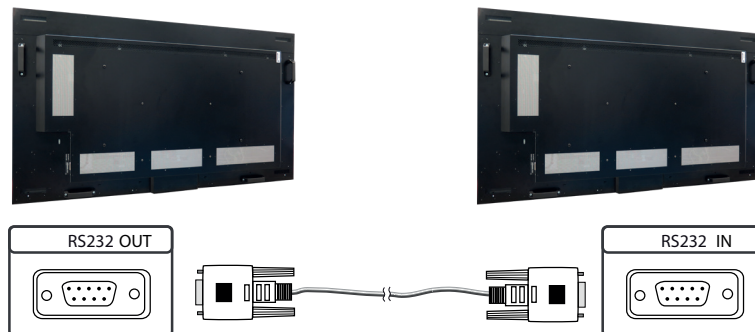

Connect to an USB stick for firmware download



Remote OSD control

You can remotely control the monitor from an external PC. To do this, connect the monitor to the PC via an RS232 cable and start the program „WallExpress“. Here you can configure the monitor or its VideoWall.

The OSD keyboard

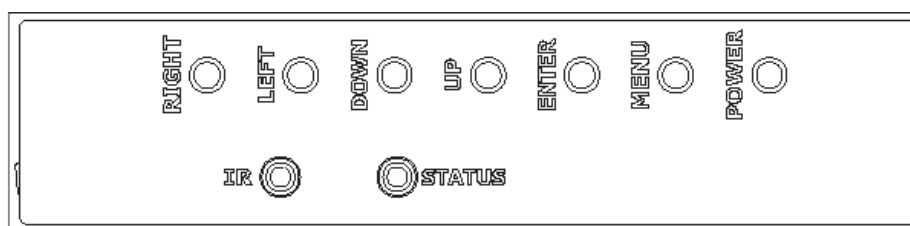

Operating the OSD menu via keyboard

Key	Operation
Power	Power On/ Off
Menu	<ul style="list-style-type: none"> • Activates main OSD menu • Navigates higher menu in main OSD menu • Stops auto frequency searching • Exits OSD menu
Enter	<ul style="list-style-type: none"> • Activates OSD menu of input source selecting • Changes input source by selecting • Executes functions (by OSD help commands) in main OSD menu • Activates Child menu
Up	<ul style="list-style-type: none"> • Navigates input source • Executes function (by OSD help commands) in main OSD menu • Navigates previous menu in main OSD menu
Down	<ul style="list-style-type: none"> • Navigates input source • Executes function (by OSD help commands) in main OSD menu • Navigates next menu in main OSD menu
Left	<ul style="list-style-type: none"> • Decreases sound volume of speaker/headphone • Executes function (by OSD help commands) in main OSD menu • Decreases values of user menu in main OSD menu
Right	<ul style="list-style-type: none"> • Increases sound volume of speaker/headphone • Executes function (by OSD help commands) in main OSD menu • Increases values of user menu in main OSD menu

Operating the OSD menu via remote control

Key	Operation
Power	Power On/ Off
Menu	<ul style="list-style-type: none"> • Activates main OSD menu • Navigates higher menu in main OSD menu • Stops auto frequency searching • Exits OSD menu
Enter	<ul style="list-style-type: none"> • Activates OSD menu of input source selecting • Changes input source by selecting • Executes functions (by OSD help commands) in main OSD menu • Activates Child menu

Key	Operation
Up	<ul style="list-style-type: none"> • Navigates input source • Executes function (by OSD help commands) in main OSD menu • Navigates previous menu in main OSD menu
Down	<ul style="list-style-type: none"> • Navigates input source • Executes function (by OSD help commands) in main OSD menu • Navigates next menu in main OSD menu
Left	<ul style="list-style-type: none"> • Decreases sound volume of speaker/headphone • Executes function (by OSD help commands) in main OSD menu • Decreases values of user menu in main OSD menu
Right	<ul style="list-style-type: none"> • Increases sound volume of speaker/headphone • Executes function (by OSD help commands) in main OSD menu • Increases values of user menu in main OSD menu
Exit	Exit OSD menu
Info	Displays input source information
Sleep	<ul style="list-style-type: none"> • Set minimum sleep timer value more than current sleep timer value when sleep timer OSD activated • If sleep timer is maximum value, disables sleep timer
Mute	Toggles sound status of speaker/headphone in mute
Source	<ul style="list-style-type: none"> • Activates OSD of source change • Deactivates OSD of source change
PSM (Picture Standard Mode)	<ul style="list-style-type: none"> • Activates OSD of picture standard mode • Deactivates OSD of picture standard mode
SSM (Sound Standard Mode)	<ul style="list-style-type: none"> • Activates OSD of sound standard • Deactivates OSD of sound standard
ARC	<ul style="list-style-type: none"> • Activates OSD of aspect ratio control • Deactivates OSD of aspect ratio control
Still	Toggles picture status between motion and still image
Pre_Ch	not used
Dual I-II/ MTS	<ul style="list-style-type: none"> • Activates OSD of MTS sound format • Deactivates OSD of MTS sound format
PIP	Toggles PIP status
PIP Input	Change PIP input sources when PIP is on
PIP Size	Change PIP image size when PIP is on
PIP Position	Change PIP position when PIP image size is not double screen
Swap	Swap main input source and PIP input source
S.Select	Select main/PIP sound source when PIP is on
PC	Selects input source of PC
TV	not used
0 ~ 9	Enter digit value to Active SET ID
Blue	Set Active SET ID
Red	Delete Active SET ID
Mix	Activates Neptune OSD menu
TTX On	Enter File List



OSD-menu

To enter the OSD settings menu, press the Menu button on the OSD keypad or the IR remote control. Now you are in the first level of the menu.

HDMI 1		Resolution : 3840x2160@60Hz
Picture	Contrast	50
Color	Brightness	50
Video Wall	Sharpness	50
PC-RGB	Hue/Saturation	
Audio	Aspect Ratio	Full Screen
Heat Control	Auto Dimming Mode	Off
Network	Dimming	100
Timer	Max Ambient	300
Other Setting	Min Ambient	100
	Ambient	0

Press „OK“ to go to the second level of the menu item.

HDMI 1		Resolution : 3840x2160@60Hz
Picture	Contrast	50
Color	Brightness	50
Video Wall	Sharpness	50
PC-RGB	Hue/Saturation	
Audio	Aspect Ratio	Full Screen
Heat Control	Auto Dimming Mode	Off
Network	Dimming	100
Timer	Max Ambient	300
Other Setting	Min Ambient	100
	Ambient	0

Press „Menu“ to go back one level.

HDMI 1		Resolution : 3840x2160@60Hz
Picture	Contrast	50
Color	Brightness	50
Video Wall	Sharpness	50
PC-RGB	Hue/Saturation	
Audio	Aspect Ratio	Full Screen
Heat Control	Auto Dimming Mode	Off
Network	Dimming	100
Timer	Max Ambient	300
Other Setting	Min Ambient	100
	Ambient	0

Press „UP“ or „DOWN“ to select another menu item.

HDMI 1		Resolution : 3840x2160@60Hz
Picture	Color Temperature	9300K
Color	Red Gain	169
Video Wall	Green Gain	164
PC-RGB	Blue Gain	153
Audio	Gamma	2.2
Heat Control	Input Color Format	Auto Select
Network	Color Range	Auto Select
Timer		
Other Setting		

1.1 Picture

Contrast

HDMI 1		Resolution : 3840x2160@60Hz
Picture	Contrast	50
Color	Brightness	50
Video Wall	Sharpness	50
PC-RGB	Hue/Saturation	
Audio	Aspect Ratio	Full Screen
Heat Control	Auto Dimming Mode	Off
Network	Dimming	100
Timer	Max Ambient	300
Other Setting	Min Ambient	100
	Ambient	0

HDMI 1		Resolution : 3840x2160@60Hz
Picture	Contrast	50 
Color	Brightness	50
Video Wall	Sharpness	50
PC-RGB	Hue/Saturation	
Audio	Aspect Ratio	Full Screen
Heat Control	Auto Dimming Mode	Off
Network	Dimming	100
Timer	Max Ambient	300
Other Setting	Min Ambient	100
	Ambient	0

Brightness

HDMI 1		Resolution : 3840x2160@60Hz
Picture	Contrast	50
Color	Brightness	50
Video Wall	Sharpness	50
PC-RGB	Hue/Saturation	
Audio	Aspect Ratio	Full Screen
Heat Control	Auto Dimming Mode	Off
Network	Dimming	100
Timer	Max Ambient	300
Other Setting	Min Ambient	100
	Ambient	0

Sharpness

HDMI 1		Resolution : 3840x2160@60Hz
Picture	Contrast	50
Color	Brightness	50
Video Wall	Sharpness	20
PC-RGB	Hue/Saturation	
Audio	Aspect Ratio	Full Screen
Heat Control	Auto Dimming Mode	Off
Network	Dimming	100
Timer	Max Ambient	300
Other Setting	Min Ambient	100
	Ambient	0

Hue

HDMI 1		Resolution : 3840x2160@60Hz
Picture	Contrast	50
Color	Brightness	Saturation
Video Wall	Sharpness	
PC-RGB	Hue/Saturation	
Audio	Aspect Ratio	
Heat Control	Auto Dimming Mode	
Network	Dimming	
Timer	Max Ambient	
Other Setting	Min Ambient	
	Ambient	

Saturation

HDMI 1		Resolution : 3840x2160@60Hz
Picture	Contrast	Hue
Color	Brightness	50
Video Wall	Sharpness	
PC-RGB	Hue/Saturation	
Audio	Aspect Ratio	
Heat Control	Auto Dimming Mode	
Network	Dimming	
Timer	Max Ambient	
Other Setting	Min Ambient	
	Ambient	

Aspect Ratio (Full Screen, Auto, 4:3, 5:4, 16:9, 1:1)

HDMI 1		Resolution : 3840x2160@60Hz
Picture	Contrast	Full Screen
Color	Brightness	Auto
Video Wall	Sharpness	4:3
PC-RGB	Hue/Saturation	5:4
Audio	Aspect Ratio	16:9
Heat Control	Auto Dimming Mode	1:1
Network	Dimming	
Timer	Max Ambient	
Other Setting	Min Ambient	
	Ambient	

Dimming (Backlight Helligkeit)

HDMI 1		Resolution : 3840x2160@60Hz
Picture	Contrast	50
Color	Brightness	50
Video Wall	Sharpness	20
PC-RGB	Hue/Saturation	
Audio	Aspect Ratio	Full Screen
Heat Control	Auto Dimming Mode	Off
Network	Dimming	100
Timer	Max Ambient	300
Other Setting	Min Ambient	100
	Ambient	0

1.2 Color

Color Temperature (3200K, 5600K, 6500K, 7800K, 9300K, User)

HDMI 1		Resolution : 3840x2160@60Hz
Picture	Color Temperature	9300K
Color	Red Gain	169
Video Wall	Green Gain	164
PC-RGB	Blue Gain	163
Audio	Gamma	2.2
Heat Control	Input Color Format	Auto Select
Network	Color Range	Auto Select
Timer		
Other Setting		

HDMI 1		Resolution : 3840x2160@60Hz
Picture	Color Temperature	3200K
Color	Red Gain	5600K
Video Wall	Green Gain	6500K
PC-RGB	Blue Gain	7800K
Audio	Gamma	9300K
Heat Control	Input Color Format	User
Timer	Color Range	
Other Setting		

Red, Green, Blue Gain

HDMI 1		Resolution : 3840x2160@60Hz
Picture	Color Temperature	User
Color	Red Gain	255
Video Wall	Green Gain	255
PC-RGB	Blue Gain	255
Audio	Gamma	2.2
Heat Control	Input Color Format	Auto Select
Network	Color Range	Auto Select
Timer		
Other Setting		

HDMI 1		Resolution : 3840x2160@60Hz
Picture	Color Temperature	User
Color	Red Gain	255
Video Wall	Green Gain	255
PC-RGB	Blue Gain	255
Audio	Gamma	2.2
Heat Control	Input Color Format	Auto Select
Network	Color Range	Auto Select
Timer		
Other Setting		

Gamma

HDMI 1		Resolution : 3840x2160@60Hz
Picture	Color Temperature	2.0
Color	Red Gain	2.2
Video Wall	Green Gain	2.35
PC-RGB	Blue Gain	2.4
Audio	Gamma	2.6
Heat Control	Input Color Format	
Network	Color Range	
Timer		
Other Setting		

Input Color Format

HDMI 1		Resolution : 3840x2160@60Hz
Picture	Color Temperature	RGB
Color	Red Gain	YPbPr
Video Wall	Green Gain	Auto Select
PC-RGB	Blue Gain	
Audio	Gamma	
Heat Control	Input Color Format	
Network	Color Range	
Timer		
Other Setting		

Color Range

HDMI 1		Resolution : 3840x2160@60Hz
Picture	Color Temperature	Auto Select
Color	Red Gain	0.255
Video Wall	Green Gain	16-235
PC-RGB	Blue Gain	
Audio	Gamma	
Heat Control	Input Color Format	
Network	Color Range	
Timer		
Other Setting		

1.3 VideoWall

This setting is required for VideoWall operation to map the monitors to the positions.

HDMI 1		Resolution : 3840x2160@60Hz
Picture	X MAX	1
Color	Y MAX	1
Video Wall	X Position	1
PC-RGB	Y Position	1
Audio	X Gap	0
Heat Control	Y Gap	0
Network	Set ID	11
Timer		
Other Setting		

- X Max: Number of columns into which the image is divided. (up to 11 columns)
- Y Max: Number of lines in which the image is divided. (up to 11 lines)
- X position: Column position of the monitor in the wall.
- Y position: Row position of the monitor in the wall.
- X Gap: Proportional value of the X-axis panel edge with the unit per thousand
- Y GAP: Proportional value of the Y-axis panel edge with the unit per thousand
- Set ID: Assigned ID of the monitor (identification for IR Remote or RS232)

1.3.1 Adjust Set ID

After activating Set ID, the following window appears:

SET ID
Current : 11 Active : 15

- Here, the ID of each monitor is set to identify it in the wall configuration.
- The ID is important to be able to address the monitor individually via the IR Remote or the RS232.
- The ID defines the total active monitors (in example 15) and the ID of the currently selected one (in example 11)
 - 1.Press the BLUE button and then use 0 ~ 9 button to select the Active SET ID.
 - 2.If Press the RED button, delete ID number.

1.3.2 Video Wall onfiguration example

In the following picture you can see an example of a 3x3 video wall. In order for the image to be displayed correctly, the values must be entered in the Video Wall menu in the OSD.

X Axis/ MAx X=3

ID 1 SetX=1 Set Y=1	ID 2 SetX=2 Set Y=1	ID 3 SetX=3 Set Y=1
ID 4 SetX=1 Set Y=2	ID 5 SetX=2 Set Y=2	ID 6 SetX=3 Set Y=2
ID 7 SetX=1 Set Y=3	ID 8 SetX=2 Set Y=3	ID 9 SetX=3 Set Y=3

Y Axis/ Max Y=3

1.3.3 Calculate and set the X Gap and Y Gap

In order to achieve the perfect visual impression of an image across several screens, the pixels must be calculated or adjusted at the respective edge of the picture. This adjustment can be set via the X / Y-GAP value in the OSD menu. The procedure is shown in the following picture.

For a classic video wall setup, the following values must be set in the OSD menu.

X Gap = 6 Y Gap = 10

If the display still looks distorted or you have realized your own layout with larger distances between the monitors, you can calculate the gap with the following formula.

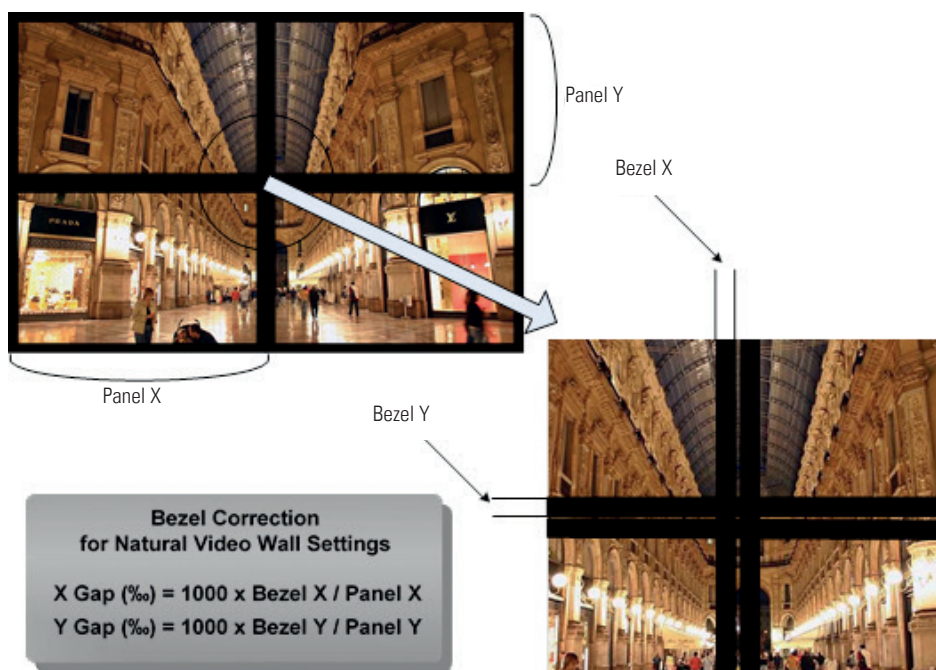

1.4 Timer

Current Time

HDMI 1		Resolution : 3840x2160@60Hz	
Picture	Current Time	Hour	1
Color	On Time	Min	40
Video Wall	Off Time		
PC-RGB			
Audio			
Heat Control			
Network			
Timer			
Other Setting			

One Time/Off Time

HDMI 1		Resolution : 3840x2160@60Hz	
Picture	Current Time	Enable	Off
Color	On Time	Hour	0
Video Wall	Off Time	Min	0
PC-RGB			
Audio			
Heat Control			
Network			
Timer			
Other Setting			

1.5 Other Setting

Language

HDMI 1		Resolution : 3840x2160@60Hz	
Picture	Language	English	
Color	Menu Transparency	français	
Video Wall	OSD Time	español	
PC-RGB	Power Save Mode	Deutsch	
Audio	Local Dimming	italiano	
Heat Control	MFC		
Network	Panorama		
Timer	Reset		
Other Setting	Software Update(USB)		
	Version		

Menu Transparency

HDMI 1		Resolution : 3840x2160@60Hz	
Picture	Language	English	
Color	Menu Transparency	20	
Video Wall	OSD Time	15 sec	
PC-RGB	Power Save Mode	Off	
Audio	Local Dimming		
Heat Control	MFC		
Network	Panorama	Off	
Timer	Reset		
Other Setting	Software Update(USB)		
	Version	v0.02 / Jan 14 2016	

OSD Time

HDMI 1		Resolution : 3840x2160@60Hz	
Picture	Language	Off	
Color	Menu Transparency	5Sec	
Video Wall	OSD Time	10 sec	
PC-RGB	Power Save Mode	15 sec	
Audio	Local Dimming	20 sec	
Heat Control	MFC	60 sec	
Network	Panorama		
Timer	Reset		
Other Setting	Software Update(USB)		
	Version		

Power Save Mode (Power off if no signal)

HDMI 1		Resolution : 3840x2160@60Hz	
Picture	Language	On	
Color	Menu Transparency	Off	
Video Wall	OSD Time		
PC-RGB	Power Save Mode		
Audio	Local Dimming		
Heat Control	MFC		
Network	Panorama		
Timer	Reset		
Other Setting	Software Update(USB)		
	Version		

Panorama (Option für gestreckte Panels)

HDMI 1		Resolution : 3840x2160@60Hz	
Picture	Language	On	
Color	Menu Transparency	Off	
Video Wall	OSD Time		
PC-RGB	Power Save Mode		
Audio	Local Dimming		
Heat Control	MFC		
Network	Panorama		
Timer	Reset		
Other Setting	Software Update(USB)		
	Version		

Reset (factory defaults)

HDMI 1		Resolution : 3840x2160@60Hz	
Picture	Language	Enter	
Color	Menu Transparency		
Video Wall	OSD Time		
PC-RGB	Power Save Mode		
Audio	Local Dimming		
Heat Control	MFC		
Network	Panorama		
Timer	Reset		
Other Setting	Software Update(USB)		
	Version		

1.6 SERIAL CONTROL PROTOCOL

1.6.1 Serial Setup

ITEM	SETTINGS
Baud rate	19200 bps
Data bit	8 bit
Stop bit	1 bit
Parity bit	none
Stream control	none

1.6.2 Serial Cable between PC and AD BOARD (simple null modem cable)

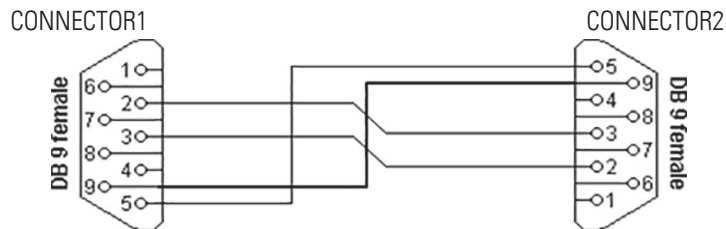

CONNECTOR 1	CONNECTOR 2	FUNCTION	
2	3	RX	TX
3	2	TX	RX
5	5	Signal ground	
9	9	IR bypass signal	

1.6.3 Logs

1.6.3.1 Virtual Remote Control

CMD	Packet (4bytes)			
0xF4	0x88	ID (0~0xFE)	0xFD	Key code

Command Format 0xFX

F = Command Start Sending

X = No of Byte to Send Current Example (0xF4)

Start Sending 4 Bytes of Packet Data

1.6.3.2 Setting Parameters to Monitor

CMD	Packet (4bytes)				
0xF5	0x88	ID (0~0xFE)	FE	PARAM.	Value

Command Format 0xFX

F = Command Start Sending

X = No of Byte to Send Current Example (0xF5)

Start Sending 5 Bytes of Packet Data

1.6.3.3 Data setting only (Not adjust function for speed)

PC

CMD	Packet (4bytes)				
0xF5	0x88	ID (0~0xFE)	FE	PARAM.	Value

Command Format 0xFX

F = Command Start Sending

X = No of Byte to Send Current Example (0xF5)

Start Sending 5 Bytes of Packet Data

AD Board Response

	CMD	Check sum.			
ACK	0xF1	PARAM	Xor	Value	
NACK	0xF1	PARAM	Xor	Value	Xor

1.6.3.4 Read Parameters from Monitor

PC

CMD	Packet (4bytes)			
0xF4	0x88	ID (0~0xFE)	0xFC	RARAM.

Command Format 0xFX

F = Command Start Sending

X = No of Byte to Send Current Example

(0xF4) Start Sending 4 Bytes of Packet Data

(0xF1) Start Sending 1 Bytes of Packet Data

AD Board Response

CMD	Packet (1byte)
0xF1	Value

1.6.4 Control Command Packages

CMD	Data1	Data2	Data3	Data4	Data5	Description	Range (HEX)		
Command	Target	ID	CMD	PARAM	Value				
0xF5 (Start Set) 0xF4 (Start Get)	0x88 (Set) 0x89 (Get)	0xXX (0x00~0xFE)	0xFE/ 0xFC Set/ Get Param.	0x00	0x00~0xFF (by min-max)	LANGUAGE	0	English	
							1	TBD	
							2	TBD	
							3	TBD	
							4	TBD	
				5		TBD			
				0x01		SOURCE *DP & HDMI1	0	VGA	
							1	DP	
							2	HDMI1	
							3	HDMI2	
							4	HDMI3	
				0x03		COLOR TEMP	0	5700K	
							1	6500K	
							2	9300K	
							3	User	
				0x04		CONTRAST	0	0	
				64			100		
				0x05		BRIGHT- NESS	0	0	
				64			100		
				0x07		SHAR- PNESS	0	0	
				64			100		
				0x0F		ASPECT RATIO	0	Full Screen	
							1	Auto	
							2	4:3	
							3	5:4	
							4	16:9	
						5	1:1		
						0x10	READ GAIN	0	0
						FF	255		
						0x11	GREEN GAIN	0	0
								FF	255
						0x12	BLUE GAIN	0	0
FF	255								
0x17	MUTE	0	MUTE ON						
		1	MUTE OFF						
0x1B	VOLUME	0	0						
		64	100						
0x23	ON HOUR	0	0						
		17	23						
0x24	ON MINUTE	0	0						
		3B	59						
0x25	ON TIME ON OFF	0	OFF						
		1	ON						
0x27	OFF HOUR	0	0						
		17	23						
0x28	OFF MINUTE	0	0						
		3B	59						

CMD	Data1	Data2	Data3	Data4	Data5	Description	Range (HEX)	
Command	Target	ID	CMD	PARAM	Value			
0xF5 (Start Set) 0xF4 (Start Get)	0x88 (Set) 0x89 (Get)	0xXX (0x00~0xFE)	0xFE/ 0xFC Set/ Get Param.	0x29	0x00~0xFF NOT SEND IN GET MODE	OFF TIME	0	OFF
						1	ON	
				0x2A		SET ID	0	TBD
						63	9	
				0x32		CURRENT HOUR	0	
						23		
				0x33		CURRENT MINUTE	0	
						59		
				0x36		REMOTE LOCK	0	OFF
						1	ON	
				0x37		ILLUMI-NANCE ⁽⁷⁾⁽⁸⁾		
				0x38		MAX_ILLU-MINANCE ⁽²⁾	2	200
						FF	25000	
				0x39		MIN_ILLU-MINANCE ⁽³⁾	1	10
						FF	2550	
				0x3A		AUTO_DIM	0	OFF
						1	ON	
				0x3B		DIM_ LEVEL ⁽⁴⁾	0	0
						64	100	
				0x3C		CURTEMP_ MAIN ⁽⁵⁾⁽⁸⁾	64	100
				0x3E		FAN ACTI-VE TEMP ⁽⁵⁾	3C	0
						B4	60	
				0x40		FAN_ CONTROL	0	OFF
						1	ON	
						2	AUTO	
				0x42		X POSITION	1	1
						0B	11	
				0x43		Y POSITION	1	1
						0B	11	
0x44	X MAX	1	1					
	0B	11						
0x45	Y MAX	1	1					
	0B	11						
0x46	X GAP ⁽⁹⁾	0	0					
	64	100						
0x47	Y GAP ⁽⁹⁾	0	0					
	64	100						
0x48	TEMP_ SHUT-DOWN ⁽⁵⁾		TBD					
		TBD						
0x6C	LOCAL DIM		TBD					
		TBD						
0x69	PC AUTO ADJUST	1						
0x6A	MFC	0	OFF					
	1	LOW						
	2	MIDDLE						
	3	HIGH						

CMD	Data1	Data2	Data3	Data4	Data5	Description	Range (HEX)	
Command	Target	ID	CMD	PARAM	Value			
0xF5 (Start Set)	0x88 (Set)	0xXX (0x00~0xFE)	0xFE/ 0xFC Set/ Get Param.	0x6B	0x00~0xFF (by min-max)	POWER SAFE MODE		TBD
				0x68	NOT SEND IN GET MODE		1	
0xFE	0			OFF				
	1			ON				
0xF4 (Start Get)	0x89 (Get)							

Notice

(1) CURSOURCE Setting Value

AV1:1, AV2:2, SVIDEO:4, COMP1:7, HDIM:11, DVI12, DSUB:10, MMP:15

(2) MAX_ILLUMINANCE Settings

Setting Value = Ambient Level (by LUX) / 100

Ex) Desired Ambient is 10000 Lux, Setting is 100 (= 10000 / 100)

(3) MIN_ILLUMINANCE Settings

Setting Value = Ambient Level (by LUX) / 10

Ex) Desired Ambient is 200 Lux, Setting is 20 (= 200 / 10)

(4) DIM_LEVEL Settings

Dimming is controlled by Brightness Settings.

(5) TEMPERATURE Settings

Setting Value = Desired temperture(by Celsius) x 2 + 60

Ex) Desired temperature is 60°C, Setting is 180 (= 60 x 2 + 60)

(6) TEMP_HYSTERESIS Settings

Setting Value = Desired Hysteresis(by Celsius) x 2

Ex) Desired Hysteresis is 2°C, Setting is 4 (= 2 x 2)

(7) ILLUMINACE

Current lux/10. If Cur_lux>2550 then Value=255

(8) Read only Command

(9) Gap Settings

Setting Value =(int) (1000 * Gap / Active)

7. Rock Pi4 module B (option)

The RockPi4 is a single board computer that is small in size compared to other computers, but is still extremely powerful. It offers excellent compatibility with various hardware and has an LPDDR4 RAM and a 64bit Hexacore processor. The RockPi4 is completely integrated into the system of the monitor and can be used like that. You will receive a 32 GB microSD card for each RockPi. You can set up an operating system on this. Ready-to-download images can be found here: <https://rockpi.eu/>

You can find the balenaEtcher for setting up the image on the microSD card here: <https://www.balena.io/etcher/>

If you have purchased a complete system with the digital signage solution from STiNO GmbH, the ready-to-use image is already on the microSD card in the monitor.

Passive cooling within the monitor

The Rock Pi is passively cooled. This means that there is a heat sink on it that absorbs and derives the heat produced by the processor. With passive cooling, there are no moving parts.

Connections RockPi

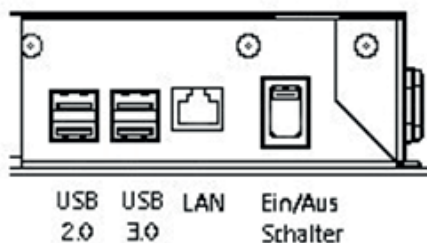

The Rock Pi 4 has, accessible on the side of the monitor, 2xUSB 2.0, 2xUSB 3.0 connections and 1xLAN connection (see picture). The RockPi4 is internally connected to an HDMI port on the controller card. You can select this port using the „Source“ button under the name „RockPi“ on your remote control.

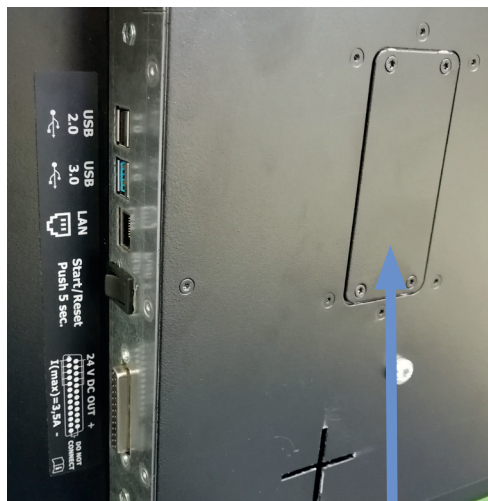

Service flap Rock Pi

Assembly and disassembly of the SD card

Before you insert or replace the SD card in the RockPi, switch off the device. There is a small service flap (see picture) on the back of the monitor (bottom left). Use a Torx10 screwdriver to remove the screws and open the flap. Below is the card slot of the Rock Pi4. You can swap the SD card as you wish and install the operating system you want.

Insert card: Before you insert an SD card into the RockPi4, you have to install a suitable operating system on the SD card. When you have done this, insert the SD card with the label facing up into the designated card slot, then close the service door again. Now you can switch on the device.

Remove card: If you want to remove the SD card, make sure that the device is switched off. You can then gently pull the SD card out with two fingers.

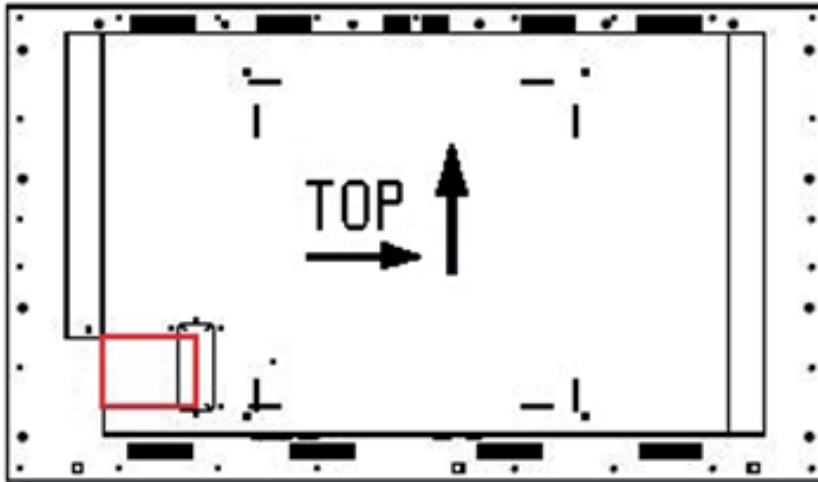

Position Rock Pi into the monitor

Note: If you change the signal source without switching off the RockPi, it is still active. This means that for devices in which a touchscreen is installed, the RockPi is activated when you enter it via the touchscreen, even though you see a different picture. If you want to use another signal source in connection with the touchscreen, you have to shut down the RockPi and link the USB connection from the touch screen to another signal source.

Switch the RockPi4 on/ off

The RockPi4 starts up automatically when the monitor is switched on. If you want to switch off the RockPi, you have to shut it down like a PC. To switch on again, restart the system or press the button on the RockPi. If the RockPi system should freeze, press the switch on the RockPi4 for approx. 5 seconds, it will then restart. If there is no incoming signal, the monitor switches off after approx. 20 seconds.

8. External PC box IQ Core™-i5



Note: The PC box is not intended for the Brilan 4K 42.5"

Note: A combination of PC box IQ Core™-i5 and Rock Pi4 is not intended.

Note: The delivery includes a driver DVD with all IQ Core™-i5 main board drivers!



Note: This box is equipped with a battery. Please read the following note carefully:

- Unplug the power cable before exchanging the battery.
- There is a risk of explosion if the battery is not installed correctly.
- Replace the battery always with a battery of the same type.
- Recycle empty batteries with the free battery collection system. Please read the chapter "Disposal" in this document.

Passive cooling

The PC box IQ Core™-i5 are designed for passive cooling. The device should be mounted with sufficient distance to the wall.

Passively cooled PC boxes have a heat pipe that routes by which the heat of the processor to a heat sink on the back of the PC. Passively cooled devices have no moving parts.

PC specification

Please inform yourself current data sheet Brilan 4K about the details of the PC specification of the IQ Core™-i5.

PC Box

The integrated PC is installed in a separate box which can be removed from the display for maintenance purposes. The PC box must be plugged into the display for operation.

The power supply for the PC and all other data lines are integrated into the plug-and-socket connection between PC box and display. Additional cables between PC box and display are not required. A dismantled PC, box can be connected to an external power supply and operated separately from the display.



PC box

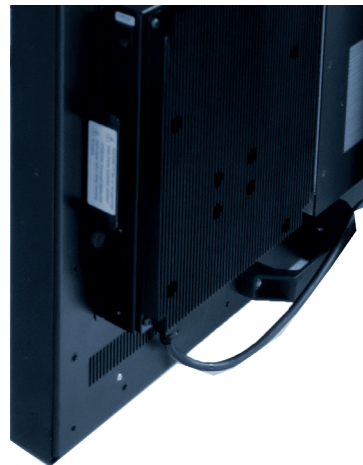

Display with PC box

Mounting and dismounting the PC box



Note: The display must be switched off before dismounting or mounting the PC box. Not confirming to the rules may electronically damage the display and the PC box.



Note: The two interfaces on the Brillan 4K Monitor may only be used for the PC-Box (option). Other uses are not permitted, otherwise they could damage the device.

To remove the PC box please proceed as follows:

- Make sure that the display is completely disconnected from power. Unplug the power cable or switch the monitor off with the main power on/off switch.
- Remove the safety screw (1) from the PC box .
- Pull carefully at the handle of the PC box and lift the PC box back away.

To mount the PC-box please proceed as follows:

- Make sure that the display is completely disconnected from power. Unplug the power cable or switch the monitor off with the main power on/off switch.
- Place the PC box on the display module. Make sure that the guide pins on the box dive into the round openings of the display module.
- Slide the PC box inward so that the connectors fully engage.
- Fix the PC box with the locking screw (1).

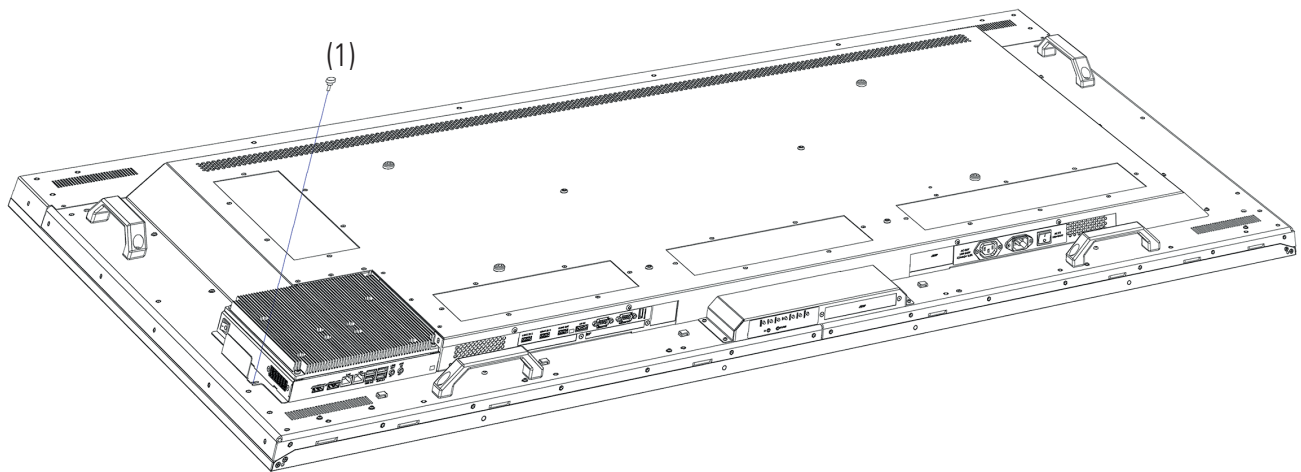

Operating the PC box without display

The PC box can be operated as stand alone device without display for maintenance purposes. This requires an external power supply (12V DC, 60 Watt) which is available as option (order number DS-91-945).

Please connect monitor, keyboard and mouse before switching on power.

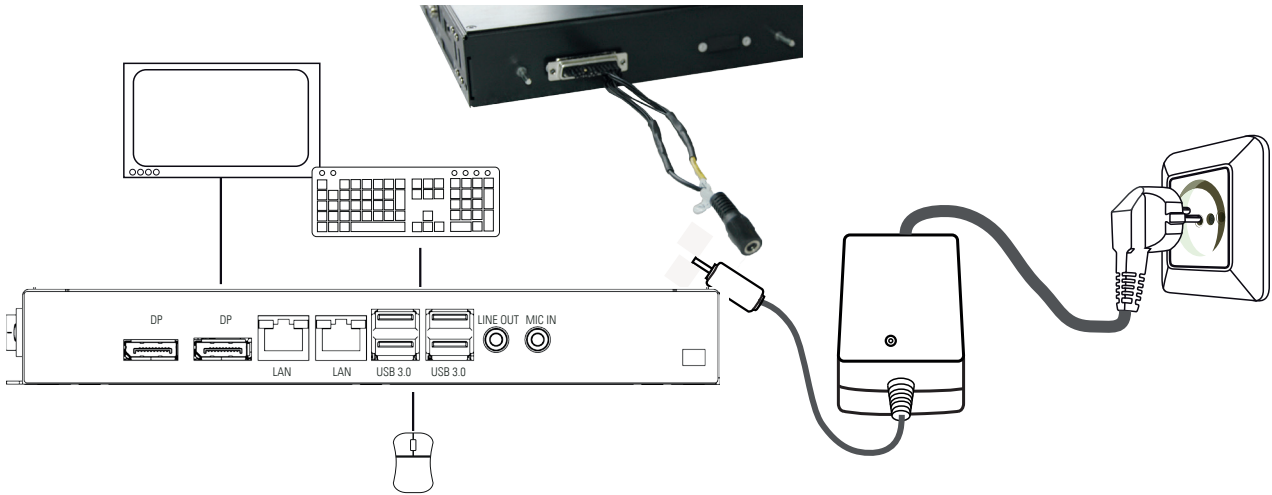

PC box connectors

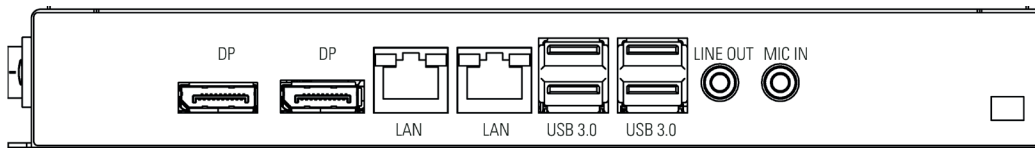

Power on/off

The display boots automatically after connecting to power. Use the push button to switch the display on and off. If in normal operation, push the push button once to shut down the system into sleep mode. The panel is switched off. If switched off, push the push button once to wake up the display.

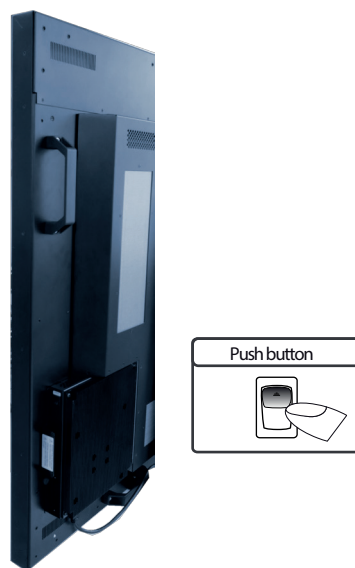

BIOS settings

A Phoenix UEFI Flash BIOS is installed on the PC main board. To change BIOS settings press the 'ENTF/DEL' key on your keyboard during the boot process of the PC.

Operating systems

An operating system is pre-installed if you has been ordered this option. In this case all main board drivers or touch drivers are installed.

Activating the operating system:

- Windows 10 IoT: This OS is already activated. The license key sticker is located on the back side of the PC.
- Windows 10: This OS is not activated. The license key sticker is added to the product documentation. After switching on the display for the first time Windows will prompt for the key.

9. Touch Sensors

Brilan 4K monitors 42,5", 54.6", 64.5" and 85.6" are available with touch option. Depending on the panel size, different touch systems and touch technologies are used. If the monitor has been ordered with touch option, the touch sensor and touch controller are installed at factory.

Brilan 4K Video:

The drivers for these monitors must be installed on your PC system. HID devices do not need drivers for Windows 10. Please contact our support center if you are using LINUX based computers.

Note: All drivers for the touch sensors can be found on the enclosed DVD.

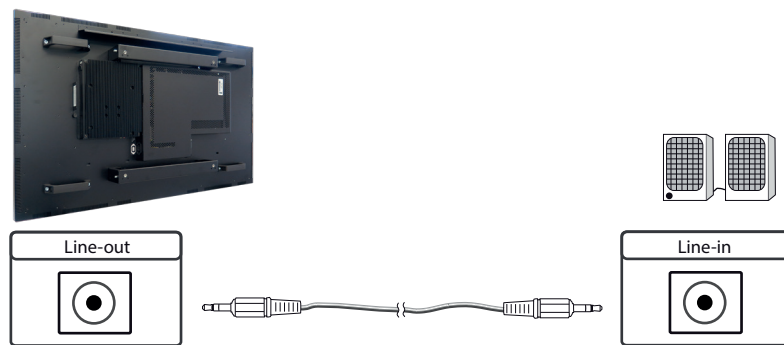

10. Maintenance

Systems with active cooling require cleaning of ventilation slots every 6 months. Systems with passive cooling must be cleaned every 12 months.

11. Warranty / Service

Warranty

Distec GmbH grants a manufacturer's warranty of two years from the date of delivery.

The rendering of warranty claims shall neither extend nor restart the warranty period.

During the warranty period, Distec shall repair product faults based on material or production defects. The warranty service is executed at Distec's discretion through repair, replacement of defective parts or by exchanging a product for a product of equal quality without charging the customer for material or labor.

Warranty claims are only accepted, if Distec receives notification of a defective product within the warranty period and the product is presented to the Distec Service Centre together with all information as specified in the RMA process.

Warranty Exclusions and Limitations

This warranty does not apply to any defect for which Distec is not responsible and which includes, but is not limited to the following:

- Unauthorized opening or disassembling of the product
- Faulty maintenance by non-observation of maintenance instructions
- Inappropriate storage or cleaning of the product
- Unauthorized modification of the product
- Incorrect use or misuse
- Non-observation of operating and installation instructions
- Permanent display of fixed images (causing image retention or image sticking)
- Operating the product in conditions which exceed the limitations of the specification
- Use of inappropriate boxes, packaging or modes of shipment
- Force majeure like fire, acts of war, acts of violence, chemical or biological impacts, lightning strikes, over voltage or similar events
- Fault resulting from the use of software which was not originally supplied with the product or which is incorrectly installed
- Normal wear and tear and wearing parts (i.e. LCD panel)

Mechanical damages like scratches, pressure or break points are excluded from this warranty.

This warranty does not include accessory parts which are not integral part of the product (as boxes, batteries).

Pixel errors only constitute a fault under the terms of this warranty if they deviate from the product specification (i.e. ISO 9241-307 pixel failure class II).

Display Quality - Prevention of after image burn in effects

After image burn-in means that an image or part of an image (i.e. logo) remains visible on the screen even if the image on the screen is changed. This should not occur if the LCD panel is operated in normal conditions with changing content. To prevent burn-in effects please follow the following guidelines.

- Power-off the monitor for 2 hours after using it for 18 hours.
- Use the power scheme and power management of the PC.
- Use plain-colored screen savers.
- Avoid patterns with a strong difference in brightness and contrast.
- Avoid gray colors.
- Change images and logos regularly. Show animated pictures for 60 seconds after 4 hours of operation.
- The best way to protect your display is to switch the monitor off when not in use or to use screen savers.

Non-observance of these guidelines may have effects on warranty.

Warranty Processing

Distec RMA process. In order to avoid unnecessary charges, it is important to adhere to the RMA regulations.

Products must be appropriately and professionally packed for a safe return to the Distec Service Centre. Products with panel sizes equal or larger than 81 cm (32") must be shipped on pallets in upright position.

Distec does not assume liability for any customer data stored on products which are returned to Distec.

Limitations of Liability and Benefits

With this warranty declaration, Distec exclusively warrants that the product is free of material and manufacturing faults.

Distec does not issue any other warranty or similar statements other than this declaration.

This warranty does not impair or affect a buyer's statutory claim against the seller due to material damage. Such claims can be asserted instead of the warranty agreed to here at the buyer's discretion.

Mandatory legal rights and mandatory claims under the German product liability remain unaffected.

Applicable Law and Place of Jurisdiction

The laws of the Federal Republic of Germany apply.

Place of jurisdiction is Munich.

Service addresses

Germany

Distec GmbH - Werk Kindel
Am Künkelhof 4
99820 Hörselberg-Hainich
☎ +49 3 69 20 71 62-0
✉ support@distec.de

Great Britain

Display Technology Ltd.
Osprey House, 1 Sprey Court
Hichingbrooke Business Park
Huntingdon, Cambridgeshire
PE29 6FN
Tel. +44 1480 411600
Mail: info@displaytechnology.co.uk

USA

Apollo Corp.
87 Raynor Avenue, Unit 1
Ronkonkoma NY 11779
☎ +1 63 15 80-43 60
✉ info@apolloedisplays.com

Please go to the following web address for further information about our RMA regulations and RMA forms:

[Http://www.distec.de/en/service](http://www.distec.de/en/service)

12. Disposal

Disposal of old devices

If the acquired Distec product is to be disposed of, must be implemented into national law the Directive 2012/19/EU.

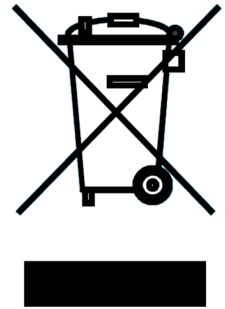

Disposal of batteries

Applicable in all countries of the EU and in countries with separate battery collection systems.

The Batteries in this product should not be disposed with other household waste. The chemical symbol Pb, CD or Hg indicate that the battery contains lead, cadmium or mercury above the reference level in EC directive 2006/66/EG.

Batteries which are not disposed correctly can cause harm environment and health.

Our environment is close to our hearts. Please help us to protect our environment and recycle empty batteries with the free battery collection system.

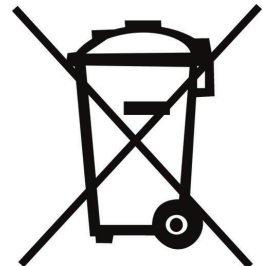

13. Declaration of Conformity

Declaration

Hereby the Distec GmbH declared that the unit EU is in compliance with the essential requirements and other relevant provisions of Directives 2014/30/EU and 2014/35/EU and 2011/65/EU.

The CE declaration of conformity can be found in English at the website of Distec: <https://www.distec.de/en/service/downloads/monitor-downloads/>.

FCC-Declaration of conformity

This equipment has been tested and found to comply with the limits for a Class A digital device, pursuant to Part 15 of the FCC Rules.

These limits are designed to provide reasonable protection against harmful interference when the equipment is operated in a commercial environment. This equipment generates, uses and can radiate radio frequency energy and, if not installed and used in accordance with the instruction manual, may cause harmful interference to radio communications.

Operation of this equipment in a residential area is likely to cause harmful interference in which case the user will be required to correct the interference at his own expense.

Canadian Department of Communications Compliance Statement

This Class A digital apparatus meets all requirements of the Canadian Interference-Causing Equipment Regulations.

Observation des normes-Class A - Cet appareil numérique de la classe B est conforme à la norme NMB-003 du Canada.

FCC Information:

- Changes or modifications not expressly approved by Distec GmbH could void the user's authority to operate the equipment.
- Use the attached specified cables with the POS-Line monitor so as not to interfere with radio and television reception.
- Please use the supplied power cord or equivalent to ensure FCC compliance.