

User Manual

POS-Line BLO Series



POS-Line monitors from 80 cm (31.5")



Copyright

The contents of this manual are subject to change without notice.

© 2022 Distec GmbH. All rights reserved.

Reproduction of this manual in parts or entirely without the previous authorization of Distec GmbH is prohibited.

Distec GmbH is not liable for errors and collateral or subsequent damage which result from supply, deployment or any other utilisation of this document.

All product names mentioned in this document are trademarks or registered trademarks of their due owners.

Table of Contents

1. General Specifications	4
2. Scope of Delivery	4
3. General Safety Regulations	5
4. First Installation.....	8
5. POS-Line Video PME BLO	10
6. POS-Line IQ BLO	18
7. WebPoster	21
8. Maintenance	23
9. Warranty / Service	23
10. Disposal	25
11. Declaration of Conformity	25

1. General Specifications

Scope of Document

This user manual is valid for POS-Line FLO monitors from 80.0 cm (31.5") up to 116.8 cm (46"). The POS-Line BLO monitors are offered in different screen sizes. All monitors are equipped with a special F30 fire protection glass and a temperature fuse for voltage-free switching from a certain temperature. The series is designed for use in fire load and flue gas sensitive environments.

Important note: This user manual is complemented by other additional documents when indicated.

All documents are also available for download from Distec web site: www.distec.de/en.

POS-Line monitor versions:

POS-Line PME BLO: Monitor with integrated controller, 1 x RGB, 1 x HDMI, 1 x Display Port.

POS-Line IQ BLO: Monitor with integrated PC Intel® Celeron® J3455 (1,5GHz/2,3GHz).

2. Scope of Delivery

When unpacking the monitor, please check if the following accessories are included in the shipment:



Note: Pictures can differ from actually supplied products.

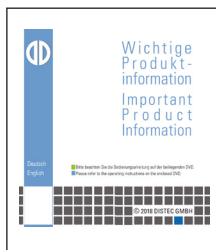

Product information



Power cable*

* Cable may vary depending on country

3. General Safety Regulations

Safety information

Please read this safety information carefully for your personal safety and for the prevention of property damage.

In case of a malfunction, immediately disconnect the power plug and contact your dealer or the next Data Display Group service centre. A malfunction is also considered if the housing, a control element or cable is damaged or if liquids or other objects penetrate the monitor.

Please read the safety information carefully before installing the device. If you have any doubts about whether the device may be used in a particular environment, please contact our service partner.

Repairs

Repairs may only be carried out by authorized technical personnel. Unauthorized access or improper repairs might cause serious property damage or cause danger to the user. In addition to that, any legitimate warranty claim expires.

Electrical connection

Disconnect the monitor from socket before executing any work. Do not touch or connect data cables or power cables during thunderstorms.

System start-up

Before the system start-up let the monitor adjust to the room temperature. Do not expose the device to direct heat sources. In case of condensation, please wait a minimum of 12 hours before switching on the monitor. The monitor shall only be installed and used according to this documentation data sheets. Only qualified personnel may perform the initial installation and system setup.

Qualified personnel

Qualified personnel, in terms of the safety information of this documentation, are persons who are qualified to activate, ground and label devices, systems and circuits according to the safety standards.

Operation

For a proper and safe utilization of the product, adequate transportation, storage, installation, assembly, careful handling and maintenance are essential. The device is only certified for in-door operation. Extreme ambient conditions shall be avoided and the monitor shall be protected from dust, humidity and heat. Do not expose the monitor to direct sunlight.

Transport

Unpack the monitor at the place of installation. Use only original packaging for transportation. Please observe these rules for any later transport.

Condensation

Avoid condensation during transport at low temperatures or at extreme fluctuations of temperature.



Safety guidelines for the handling of LCD monitors

- If the device is not used for a long period of time, unplug the power cable.
- Do not unplug the power cable while the device is powered on, except for emergencies.
- To unplug the device without problems, sockets have to be easily accessible.
- Ensure that the power cable does not get pinched or kinked.
- Do not place heavy objects on the power cable.

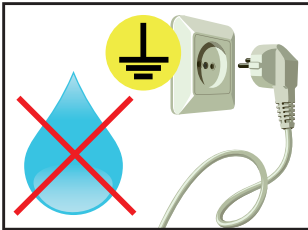

- Do not use damaged or loose sockets to plug in the device.
- Plug the device in earthed sockets only.
- Operate the device with the power cables included in the delivery packet only.
- Use undamaged power cables only.
- When plugging in and out, do not touch the power cable with wet hands.
- Ensure that the power cable is plugged in the socket safely and correctly.
- Use for devices with external power supply only the supplied original power supply, or an equivalent Low Power Source (LPS).

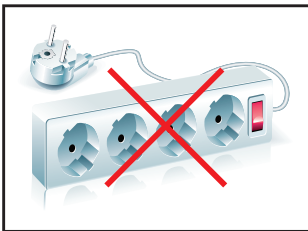

- Do not use extension block to plug several devices into a single socket.



- According to the size, devices may be difficult to handle and very heavy. Ensure that at least two people lift and carry the device.
- Put down the device slowly and carefully to avoid damaging the LCD screen. Ensure that the device stands stable.
- Keep packaging away from children. Danger of suffocation!
- Use our specified and professionally mounted wall mounting only.

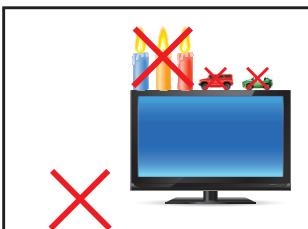

- Do not put objects onto the device.
- Do not place candles, heaters or humidifier near the device.
- Keep the device away from fireplaces and flammable materials.

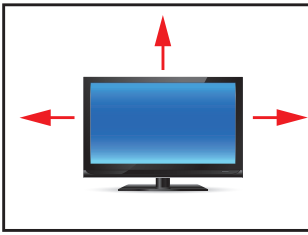

- Ensure sufficient ventilation of the device.
- Keep a minimum distance of at least 10 mm devices to the wall, for devices with integrated PC of at least 40 mm.
- Ensure compliance with the operating temperature.

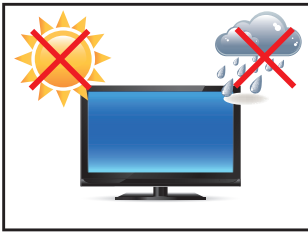

- Do not install the device in places where it is exposed to environmental impacts such as rain or direct sunlight.
- Do not install the device in places where it is exposed to high humidity, dust or smoke. In case of doubt, please contact your sales partner.



- Please use a soft, moist cloth for cleaning.
- For cleaning the screen, please use only commercially available screen cleaner. Do not spray the cleaner directly to the device but onto a cloth.
- Please clean ventilation slots regularly to ensure a good air circulation.

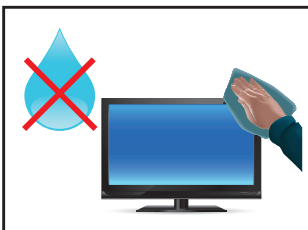

- Protect your device from water splash.
- When cleaning, please make sure that no liquids get into the device.
- Screens and surfaces can be easily scratched. Therefore, please use the prescribed cloth only.



- Attention! High voltage! Never open the device by yourself.
- In case of unusual noises, burnt smell or smoke unplug the power cable.
- Do not insert objects into the device through the ventilation slots.
- If the same picture is displayed over a longer period of time, an after-image may arise.
- When exchanging batteries of remote control, pay attention to the polarity. Keep batteries away from children and ensure an environmentally correct disposal.

4. First Installation

Position of connectors and controls

All connectors for power and cables are located at the bottom of the back side of the display.

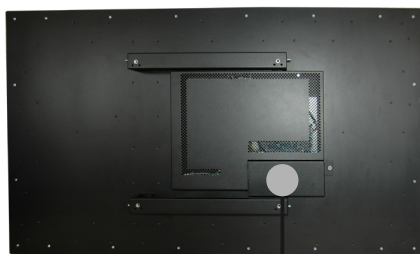

Video signal cables and OSD keyboard (video series only)
Power cable and on/off switch

Mounting

Distance to wall:

- devices without integrated PC: min. 10 mm
- devices with integrated PC: min. 40 mm

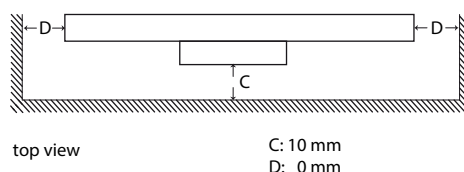
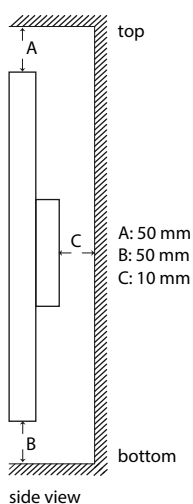

Mounting with VESA compatible brackets

POS-Line displays are shipped with factory installed mounting angles for VESA compatible brackets. The mounting angles are, without further modification suited for landscape or portrait mode and comply with the minimum required distances between the back side of the display and the wall. The operating position of the device is perpendicular (90 degrees to the floor). Pay attention to the permissible tilt angle for wall mounting.

The device can be operated both in landscape mode and in portrait mode. The information is for positioning to note on the back of the device, always.

For mounting on the pre-assembled VESA brackets, a suitable wall bracket must be used whose load-bearing capacity corresponds to the weight of the monitor. For fastening to the VESA brackets, use 4 metal screws of size M6x25.

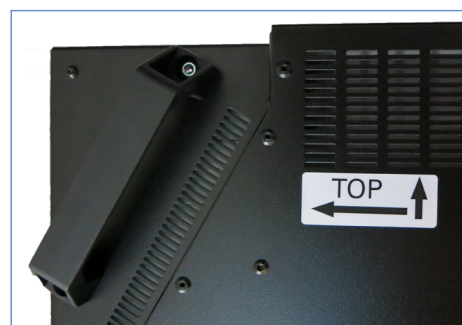

VESA standards:
 31.5" - 54.6" displays: MIS-F 400 x 400 mm (M6)

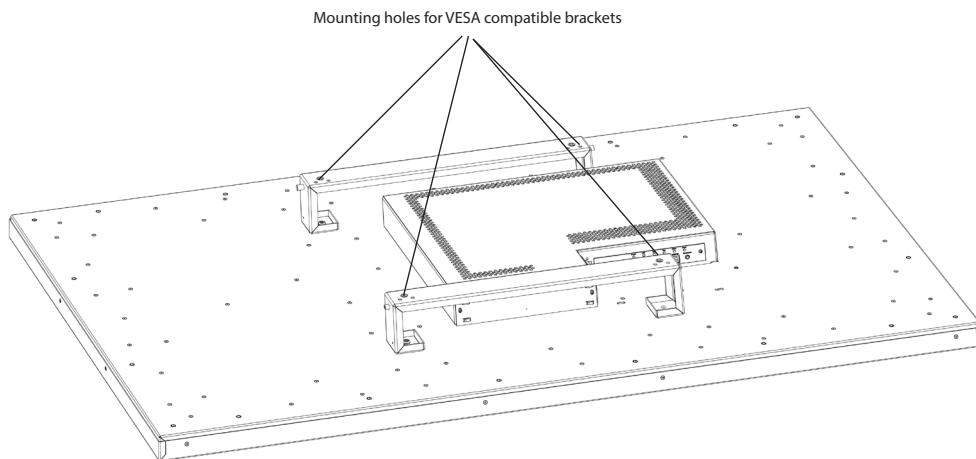

Allowed tilt angle for mounting



Attention! All monitors are to be mounted only with a tilt angle of 0°— -30°.

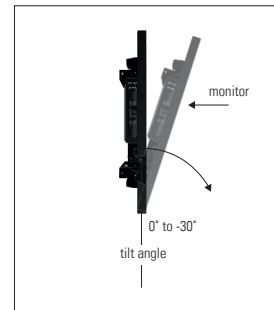

Connecting to power

POS-Line displays require a voltage of 110V - 230V AC.



Note: Install all data cables to external devices before connecting the display to power.

- Switch the on/of switch in position off.
- Connect the power cable to the display.
- Connect the power cable to a power socket.
- Switch the display on .

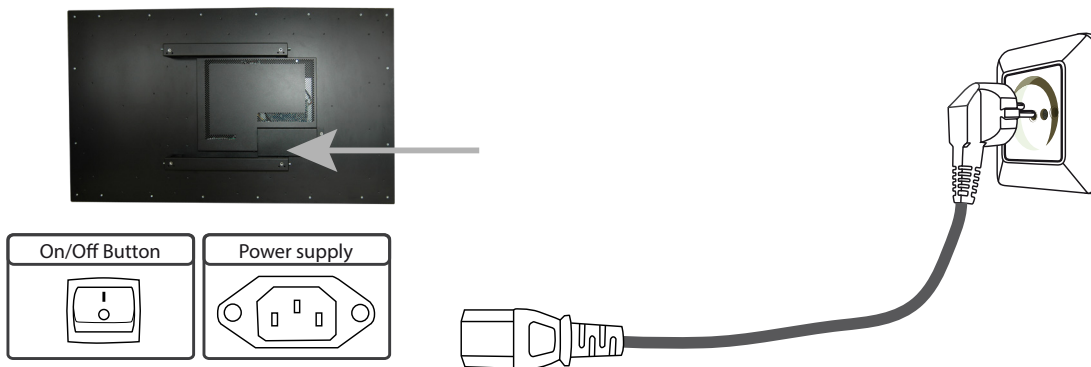

5. POS-Line Video PME BLO

Connectors and OSD buttons of POS-Line Video PME BLO series

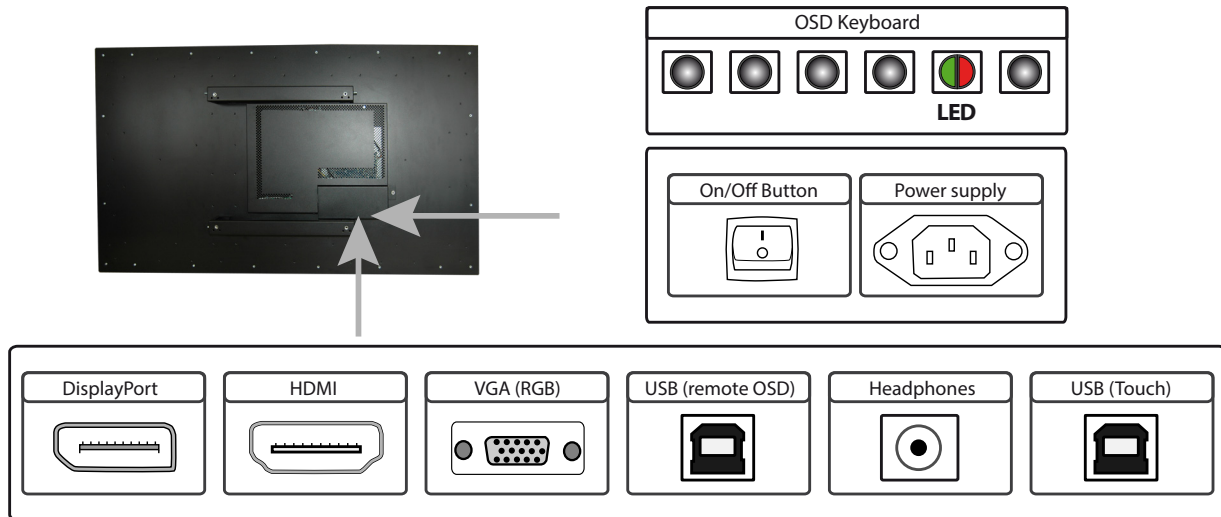

Connecting to a PC with VGA cable

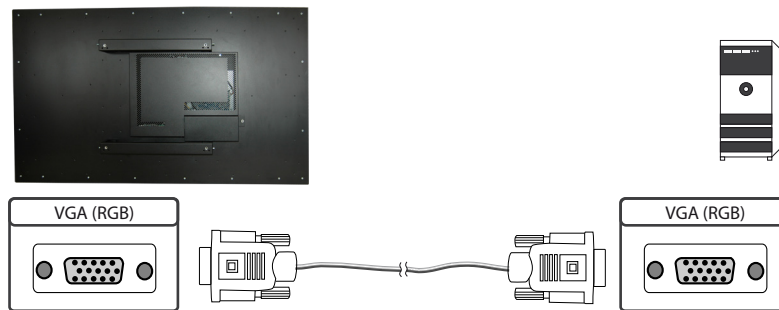

Connecting to a PC with HDMI-DVI cable

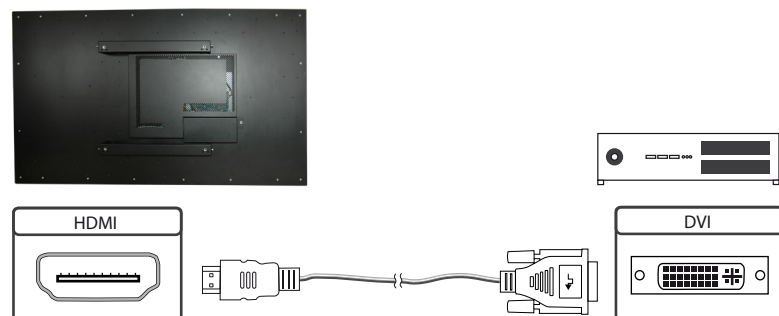

Connecting to a PC with HDMI cable

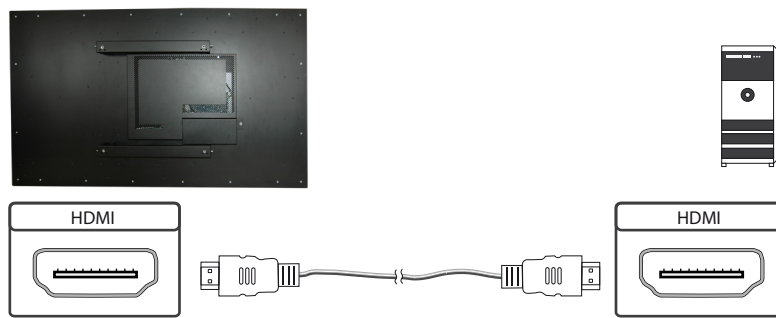

Connecting to a PC with DisplayPort cable

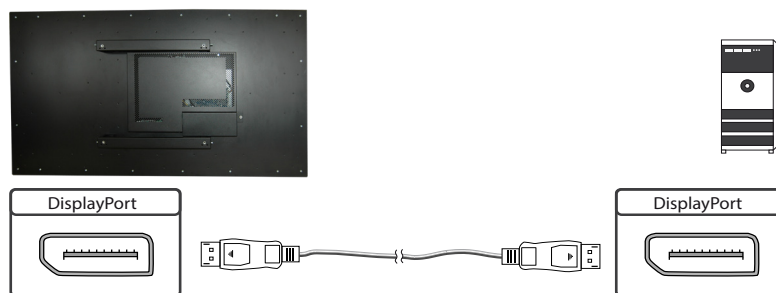

Connecting the Remote-OSD to a PC with USB cable

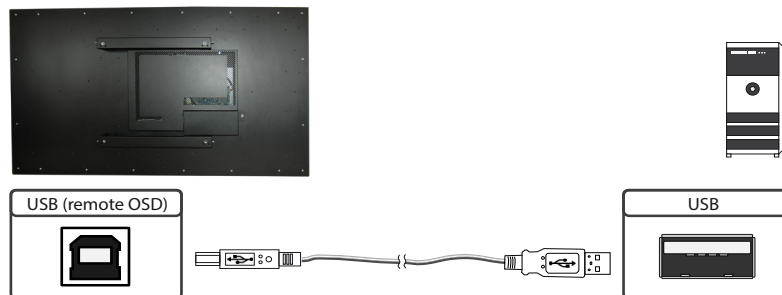

Remote OSD control

You can control the monitor remotely from an external computer. To do this, connect the monitor and computer as described above a USB cable. Please read the instructions for the remote control, which you can find on our homepage: <https://www.distec.de/en/service/downloads/monitore-downloads/>.

OSD keyboard

OSD functions of the monitor can be controlled via OSD key pad. The OSD allows selection of input source and fine tuning of various functional parameters like brightness, contrast etc.

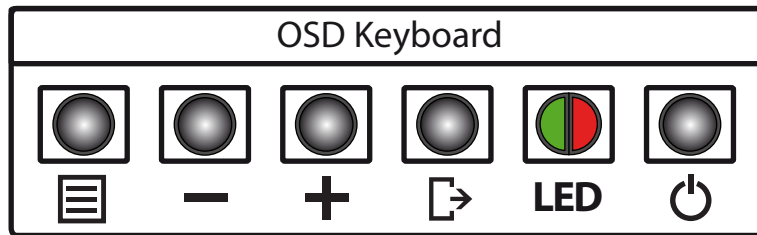

The OSD control can either be used:

- to access various functions directly
- to navigate within the OSD

The following two tables give an overview about the functions:

Direct functions:

Key	Function	Comment
Menu	Open the OSD menu	
—	Open volume control	
+	Open brightness control	
Exit	Select signal input	
Power	On/ Off	

Navigation in OSD menu:

Key	Function	Comment
Menu	Open sub menu	when in main
	Confirm entry	when in main
—	Cursor down	when in main or in sub menu
	Cursor/ slider to the left	when in main or in sub menu
+	Cursor up	when in main or in sub menu
	Cursor/ slider to the right	when in main or in sub menu
Exit	Leave OSD menu	when in main
	Leave sub menu	when in sub menu

The green/red LEDs (single package) on the external keypad show the current status of the board:

Color	Meaning	Remark
Green	Signal found	
Green blink	Search signal	
Red	Power safe mode	
LED off	Monitor off	

OSD menu

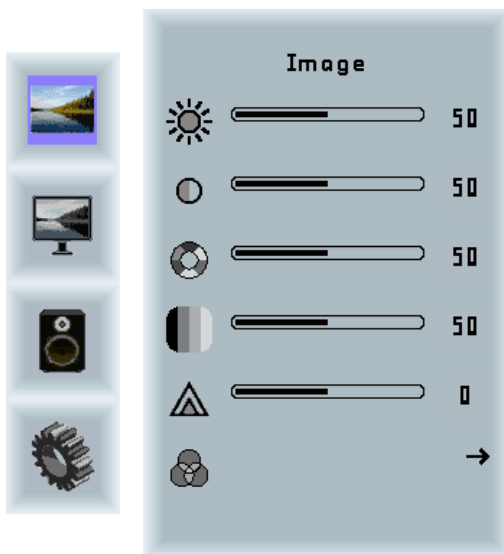

Image Menu

- Brightness: Panel brightness adjustment.
- Contrast: Panel contrast adjustment.
- Hue: Panel hue adjustment.
- Saturation: Panel saturation adjustment.
- Sharpness: Panel sharpness adjustment.
- Color: Opens the color sub menu.



Color Sub Menu

- Auto: Performs auto color adjustment.
- Color Temp: Allow selection of different color temperature schemes, predefined and custom. Available if color space of input is RGB.
- Full color: Selects full received color space.
- SRGB: Selects SRGB color space.
- XVYCC: Selects XVYCC color space.

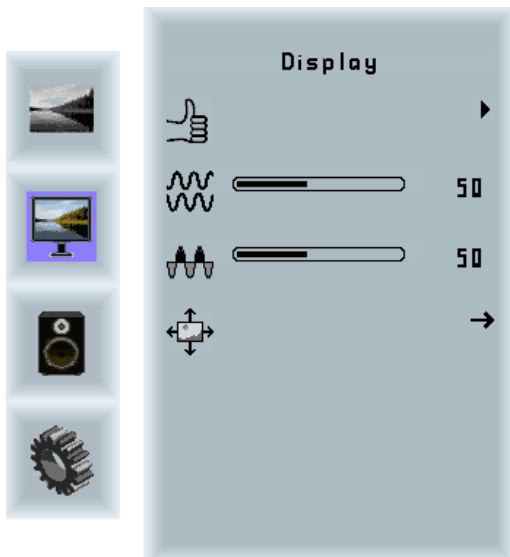

Display Menu

- Auto-adjust: Performs auto-adjustment on the VGA input image.
- Phase: This function is a slider to adjust the sampling phase of the analogue interface. For optimum image quality, input pixels should be sampled at the ideal sampling points.
- Clock: This function is a slider to adjust the sample clock of the analogue interface. This is helpful for improving the image quality for non-standard display modes.
- Position: Used to alter placement of the image.

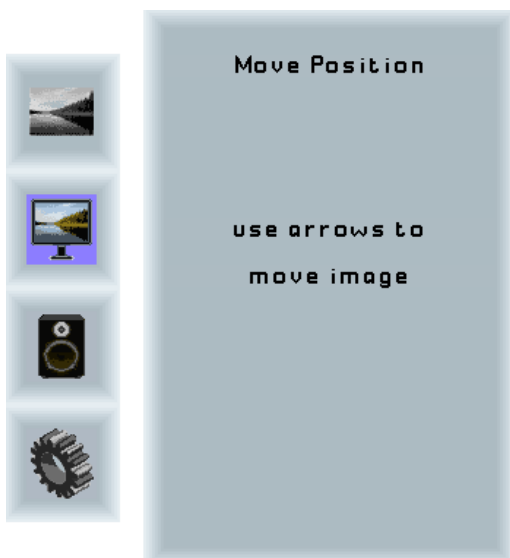

Move Position Sub Menu

- Arrows: Use arrow keys to move the position of the image on the screen.

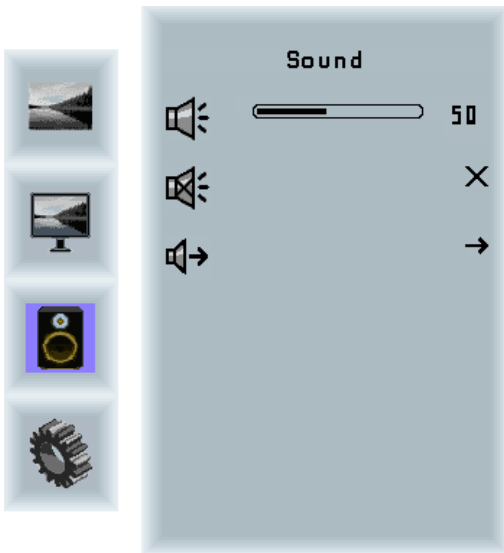

Sound Menu

- Volume: Slider bar to adjust volume.
- Mute: Mutes audio.
- Output: Chooses between speakers and headphone. Only one can be active at a time (Speakers are not available for POS-Line monitors).

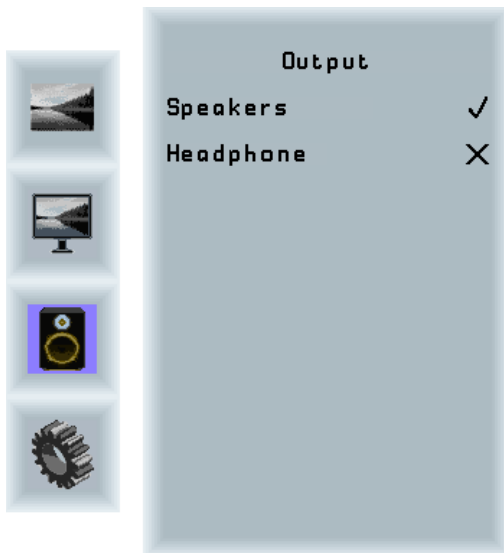

Output Sub Menu

- Speakers: Toggles speakers on/ off.
- Headphone: Toggles headphone on/ off.



System Menu

- Input source: Sub menu to select input source.
- OSD settings: Sub menu for OSD settings.
- Factory reset: Sub menu for Factory Reset.
- EDID settings: Sub menu for EDID settings.
- FW Revision: Firmware revision.
- OSD Revision: OSD revision.

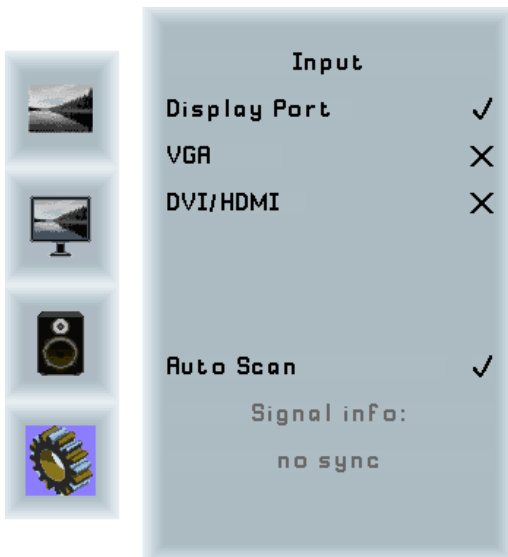

Input Sub Menu

Display Port: Select display port as input signal.
 VGA: Select VGA as input signal.
 DVI/HDMI: Select DVI/ HDMI as input signal.
 Auto Scan: Enable/ disable input auto-scan.



OSD Settings Sub Menu

Timer: Sub menu for timer settings.
 Rotation: Sub menu for rotation settings.
 Position: Sub menu for image position.
 Transparency: Slider to set transparency.



Timer Sub Menu

Timer: Selects how many seconds the OSD will remain active after the last use.

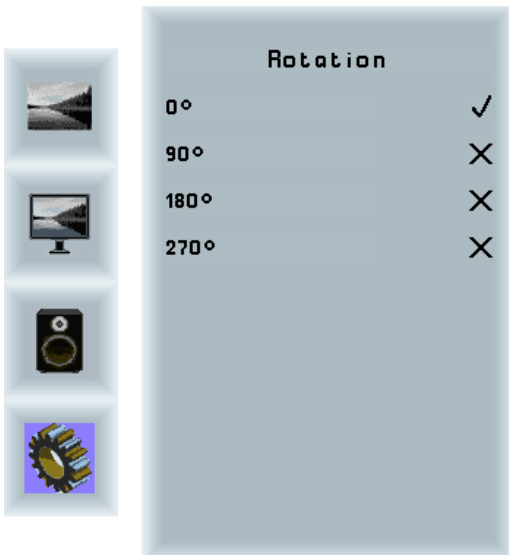

Rotation Sub Menu

Rotation: Rotates the OSD menu.



Reset Sub Menu

Reset: Performs factory reset.



EDID Write Protect Sub Menu

Write protect: EDID write protect on/ off.

6. POS-Line IQ BLO



Note: All the Celeron main board drivers you can find at: <https://www.distec.de/en/service/downloads/monitor-downloads/>



Note: This POS-Line display is equipped with a battery. Please read the following note carefully:

- Unplug the power cable before exchanging the battery.
- There is a risk of explosion if the battery is not installed correctly.
- Replace the battery always with a battery of the same type.
- Recycle empty batteries with the free battery collection system. Please read the chapter "Disposal" in this document.

Passive cooling

POS-Line displays of the IQ BLO series (integrated PC) are designed for passive cooling.

Passively cooled monitors have a heat pipe that routes by which the heat of the processor to a heat sink on the back of the monitor. Passively cooled devices have no moving parts.

PC specification

Please inform yourself current data sheet POS Line large about the details of the PC specification of the IQ BLO.

PC box connectors

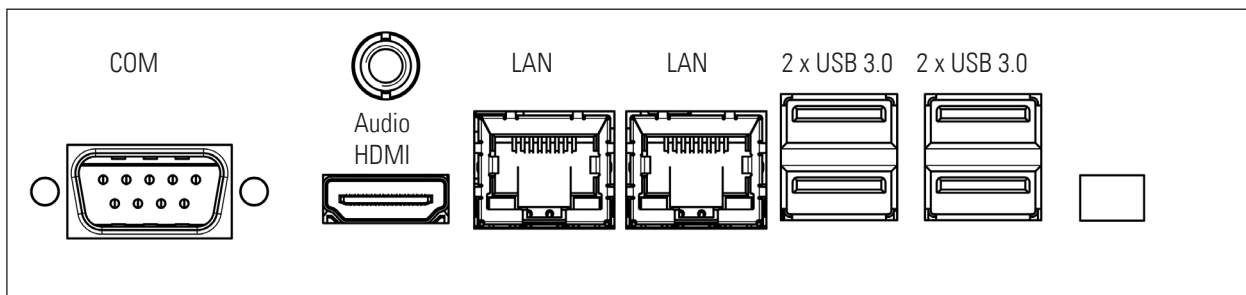

Connectors of POS-Line IQ BLO series

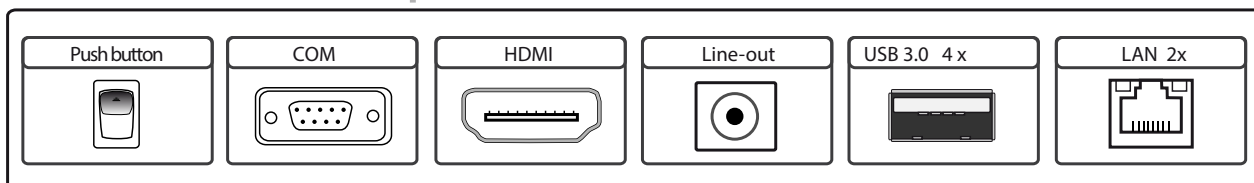
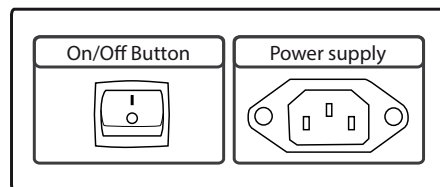
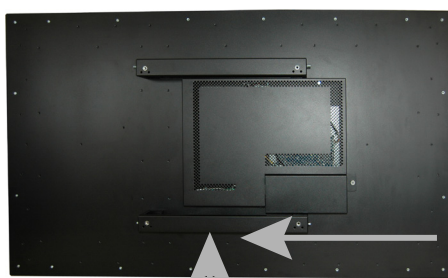

Connecting to a network using a patch cable

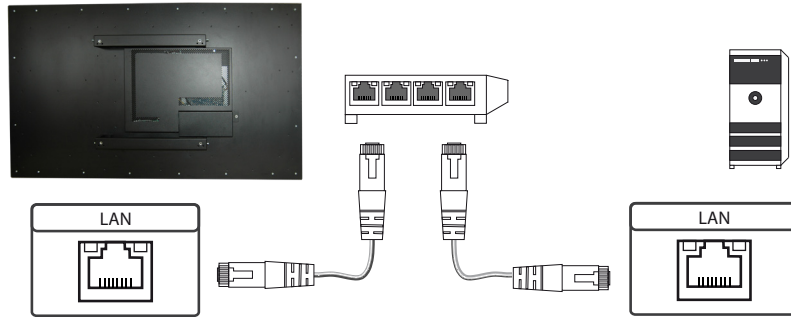

Connecting to a PC using a cross-over cable

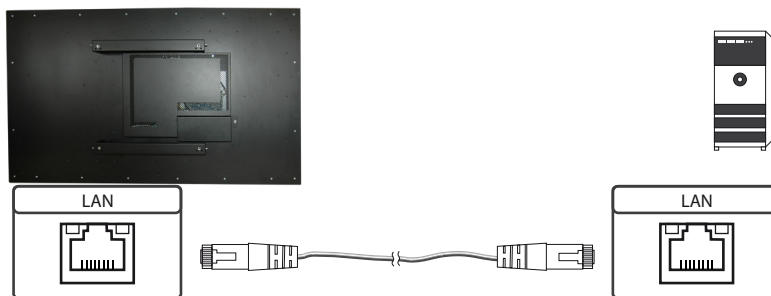

Connecting keyboard and mouse with USB cable

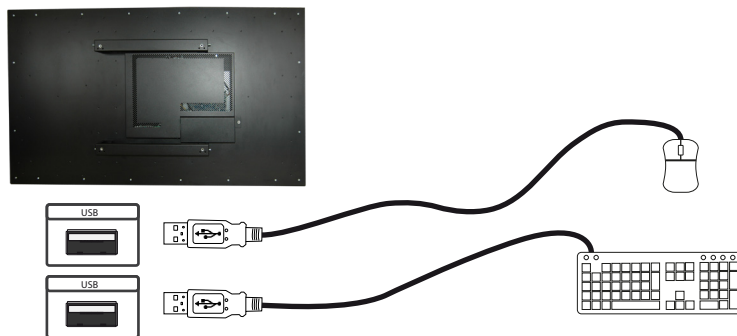

Connecting an external monitor with HDMI cable

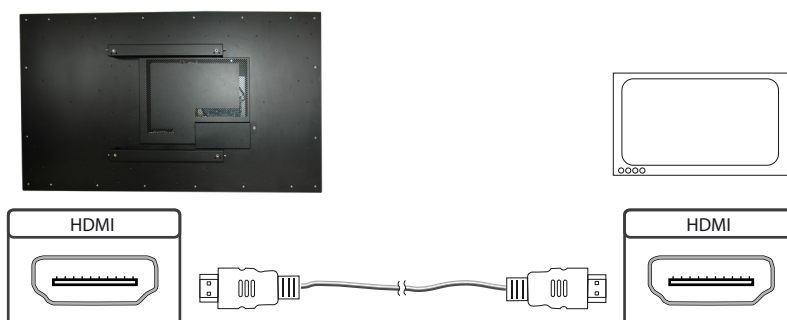

Connecting active speakers with audio cable

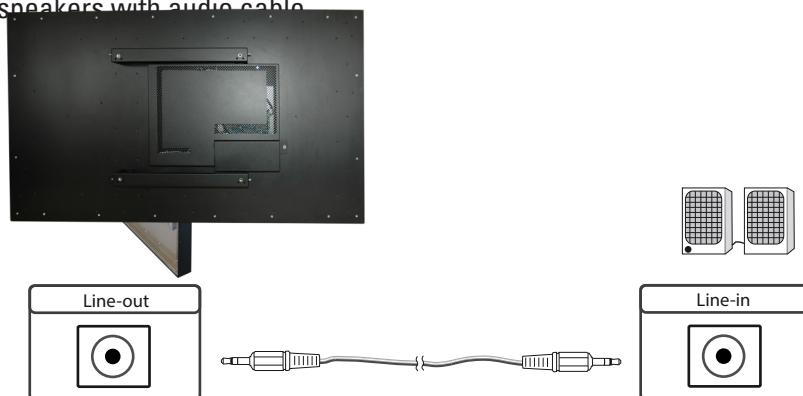

Power on/off

After applying the supply voltage, the PC starts automatically. When the power supply is connected, the PC is switched on or off with the push button. During operation, the PC is shut down by briefly pressing the push button. Briefly pressing the push button switches the PC on.

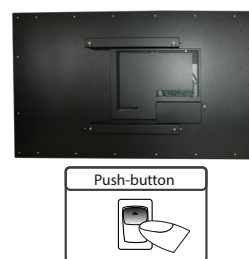

BIOS settings

A Phoenix UEFI Flash BIOS is installed on the PC main board. To change BIOS settings press the 'Entf' key on your keyboard during the boot process of the PC.

Operating systems

An operating system is pre-installed if your POS-Line display has been ordered with this option. In this case all main board drivers or touch drivers are installed.

Activating the operating system:

- Windows IoT: This OS is already activated. The license key sticker is located on the back side of the display.
- Windows 10: This OS is not activated. The license key sticker is added to the product documentation. After switching on the display for the first time Windows will prompt for the key

7. WebPoster

Connections and controls

WebPoster are POS-Line IQ BLO devices with a special firmware, so the ports and operating in the „IQ Celeron“ must be observed. Connecting a mouse and keyboard is not supported with this firmware.

Functional description

The Industrial HTML Full HD Player is a complete solution for viewing Web pages. The website can be configured via a web interface. At the start of the device is automatically display.

Configuration of the media player on delivery (factory configuration)

This device is a LAN (Ethernet) enabled device. Please note that an incorrect network configuration the device may affect the safe operation of the entire network and in the worst case of a network failure leads. To set up the device for a specific network, you need the key operating parameters of the network be known. The POS Line WebPoster is shipped from the factory with the following configuration:

- DHCP: on
- IP-Address: 192.168.0.1*
- Netmask: 255.255.255.0
- Hostname: WebPoster-xx-xx-xx (the last 6 bytes of the MAC address of the device)
- Login Name: Artista
- Password: Artista

*If no DHCP server is found, this IP address is assigned automatically.

Supported site formats

- HTML5
- JavaScript

Software

On our website you will find software and related documentation: <https://www.distec.de/en/service/downloads/webposter-downloads/>.

ADF: A program that simplifies the installation and configuration of HTML players. Connect any HTML player in the factory configuration to the network and start ADF. It displays all the HTML players in a list. Select the devices one by one and remove the network configuration.

Configuration of the media player

The configuration of the HTML player can work with any standard web browser (Firefox, Internet Explorer, Chrome, etc.) are performed. Connect the HTML player to a network and enter to establish the connection URL (eg. as IP address or network name) in the browser. Now open the WEB interface. If you are prompted for the password, enter the password (factory setting: Login name: Artista; password: Artista).

Layout of the web interface::

Configuration

Network Configuration:	The configuration of the network is the first step in setting up.
Submit Configuration:	With Submit Configuration the entries will be accepted.
Discard Changes:	With Discard Changes be deleted entries in the fields. However, this has no influence on the current configuration.
Browser Settings:	The configuration of the Web page to display is the second step of the device. Here the web page can be entered and a „Reload Interval (seconds)“ can be defined.
Submit Configuration:	With Submit Configuration the entries will be accepted.
Discard Changes:	With Discard Changes be deleted entries in the fields.
Change Password:	Here, the default password can be changed.

Information

System Information: This page contains all details about the system, such as, for example, the software version. If you contact our Support please add this page to your E-Mail to ensure a fast response.

Restart

Restart: Restart of the media player.

Display of IP address and hostname

When booting the HTML player's current IP address and the host name of the HTML player is displayed on the screen for about 5 seconds.

8. Maintenance

Systems with active cooling require cleaning of ventilation slots every 6 months. Systems with passive cooling must be cleaned every 12 months.

9. Warranty / Service

Warranty

Distec GmbH grants a manufacturer's warranty of two years from the date of delivery.

The rendering of warranty claims shall neither extend nor restart the warranty period.

During the warranty period, Distec shall repair product faults based on material or production defects. The warranty service is executed at Distec's discretion through repair, replacement of defective parts or by exchanging a product for a product of equal quality without charging the customer for material or labor.

Warranty claims are only accepted, if Distec receives notification of a defective product within the warranty period and the product is presented to the Distec Service Centre together with all information as specified in the RMA process.

Warranty Exclusions and Limitations

This warranty does not apply to any defect for which Distec is not responsible and which includes, but is not limited to the following:

- Unauthorized opening or disassembling of the product
- Faulty maintenance by non-observation of maintenance instructions
- Inappropriate storage or cleaning of the product
- Unauthorized modification of the product
- Incorrect use or misuse
- Non-observation of operating and installation instructions
- Permanent display of fixed images (causing image retention or image sticking)
- Operating the product in conditions which exceed the limitations of the specification
- Use of inappropriate boxes, packaging or modes of shipment
- Force majeure like fire, acts of war, acts of violence, chemical or biological impacts, lightning strikes, over voltage or similar events
- Fault resulting from the use of software which was not originally supplied with the product or which is incorrectly installed
- Normal wear and tear and wearing parts (i.e. LCD panel)

Mechanical damages like scratches, pressure or break points are excluded from this warranty.

This warranty does not include accessory parts which are not integral part of the product (as boxes, batteries).

Pixel errors only constitute a fault under the terms of this warranty if they deviate from the product specification (i.e. ISO 9241-307 pixel failure class II).

Display Quality - Prevention of after image burn in effects

After image burn-in means that an image or part of an image (i.e. logo) remains visible on the screen even if the image on the screen is changed. This should not occur if the LCD panel is operated in normal conditions with changing content. To prevent burn-in effects please follow the following guidelines.

- Do not display fixed patterns for an extended time period of more than 12 hours.
- Power-off the monitor for 4 hours after using it for 20 hours, and for 2 hours after using it for 12 hours.
- Use the power scheme and power management of the PC.
- Use plain-colored screen savers.
- Avoid patterns with a strong difference in brightness and contrast.
- Avoid gray colors.
- Change images and logos regularly. Show animated pictures for 60 seconds after 4 hours of operation.
- The best way to protect your display is to switch the monitor off when not in use or to use screen savers.

Non-observance of these guidelines may have effects on warranty.

Warranty Processing

Group RMA process. In order to avoid unnecessary charges, it is important to adhere to the RMA regulations.

Products must be appropriately and professionally packed for a safe return to the Distec Service Centre. Products with panel sizes equal or larger than 81 cm (32") must be shipped on pallets in upright position.

Distec does not assume liability for any customer data stored on products which are returned to Distec.

Limitations of Liability and Benefits

With this warranty declaration, Distec exclusively warrantys that the product is free of material and manufacturing faults.

Distec does not issue any other warranty or similar statements other than this declaration.

This warranty does not impair or affect a buyer's statutory claim against the seller due to material damage. Such claims can be asserted instead of the warranty agreed to here at the buyer's discretion.

Mandatory legal rights and mandatory claims under the German product liability remain unaffected.

Applicable Law and Place of Jurisdiction

The laws of the Federal Republic of Germany apply.

Place of jurisdiction is Munich.

Service addresses

Germany

Distec GmbH - Werk Kindel
Am Künkelhof 4
99820 Hørselberg-Hainich
☎ +49 3 69 20 71 62-0
✉ support@distec.de

Great Britain

Display Technology Ltd.
Osprey House, 1 Osprey Court,
Hinchingbrooke Business Park,
Huntingdon, Cambridgeshire, PE29 6FN
Tel +44 1480 411600
✉ info@displaytechnology.co.uk

USA

Apollo Corp.
87 Raynor Avenue, Unit 1
Ronkonkoma NY 11779
☎ +1 63 15 80-43 60
✉ info@apolloDisplays.com

Please go to the following web address for further information about our RMA regulations and RMA forms:
[Http://www.distec.de/en/service](http://www.distec.de/en/service)

10. Disposal

Disposal of old devices

If the acquired Distec product is to be disposed of, must be implemented into national law the Directive "2012/19 / EU".

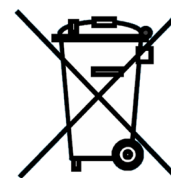

Disposal of batteries

Applicable in all countries of the EU and in countries with separate battery collection systems.

The Batteries in this product should not be disposed with other household waste. The chemical symbol Pb, CD or Hg indicate that the battery contains lead, cadmium or mercury above the reference level in EC directive 2006/66/EG.

Batteries which are not disposed correctly can cause harm environment and health.

Our environment is close to our hearts. Please help us to protect our environment and recycle empty batteries with the free battery collection system.

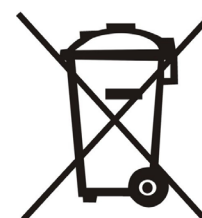

11. Declaration of Conformity

Declaration

Hereby the Distec GmbH declared that the unit EU is in compliance with the essential requirements and other relevant provisions of Directives 2014/30/EU, 2014/35/EU and 2011/65/EU.

If you need a CE declaration of conformity, please request it from support on our website: <https://www.distec.de/en/service/technical-support/>.