



OUR GLOBAL
COMPETENCE
CENTRES

 APOLLO DISPLAY
TECHNOLOGIES



 DISTEC



 DISPLAY
TECHNOLOGY



Manual

iBase

ASB200-953

**Fanless BoxPC with IBASE IB953 3.5" Single Board Computer 11th Gen Intel® Core™ U-Series
Processor**



The information contained in this document has been carefully researched and is, to the best of our knowledge, accurate. However, we assume no liability for any product failures or damages, immediate or consequential, resulting from the use of the information provided herein. Our products are not intended for use in systems in which failures of product could result in personal injury. All trademarks mentioned herein are property of their respective owners. All specifications are subject to change without notice.

ASB200-953
Fanless System with
3.5" Disk-Size SBC System

User's Manual

Version 1.0
(March 2022)



Copyright

© 2022 IBASE Technology, Inc. All rights reserved.

No part of this publication may be reproduced, copied, stored in a retrieval system, translated into any language or transmitted in any form or by any means, electronic, mechanical, photocopying, or otherwise, without the prior written consent of IBASE Technology, Inc. (hereinafter referred to as "IBASE").

Disclaimer

IBASE reserves the right to make changes and improvements to the products described in this document without prior notice. Every effort has been made to ensure the information in the document is correct; however, IBASE does not guarantee this document is error-free. IBASE assumes no liability for incidental or consequential damages arising from misapplication or inability to use the product or the information contained herein, nor for any infringements of rights of third parties, which may result from its use.

Trademarks

All the trademarks, registrations and brands mentioned herein are used for identification purposes only and may be trademarks and/or registered trademarks of their respective owners.

Compliance

CE

This product has passed CE tests for environmental specifications and limits. This product is in accordance with the directives of the Union European (EU). If users modify and/or install other devices in this equipment, the CE conformity declaration may no longer apply.

FCC

This product has been tested and found to comply with the limits for a Class B device, pursuant to Part 15 of the FCC Rules. These limits are designed to provide reasonable protection against harmful interference in a residential installation. This equipment generates, uses and can radiate radio frequency energy and, if not installed and used in accordance with manufacturer's instructions, may cause harmful interference to radio communications.

WEEE



This product must not be disposed of as normal household waste, in accordance with the EU directive of for waste electrical and electronic equipment (WEEE - 2012/19/EU). Instead, it should be disposed of by returning it to a municipal recycling collection point. Check local regulations for disposal of electronic products.

Green IBASE



This product is compliant with the current RoHS restrictions and prohibits use of the following substances in concentrations exceeding 0.1% by weight (1000 ppm) except for cadmium, limited to 0.01% by weight (100 ppm).

- Lead (Pb)
- Mercury (Hg)
- Cadmium (Cd)
- Hexavalent chromium (Cr6+)
- Polybrominated biphenyls (PBB)
- Polybrominated diphenyl ether (PBDE)

Important Safety Information

Carefully read the precautions before using the device.

Environmental conditions:

- Lay the device horizontally on a stable and solid surface in case the device may fall, causing serious damage.
- Leave plenty of space around the device and do not block the openings for ventilation. NEVER DROP OR INSERT ANY OBJECTS OF ANY KIND INTO THE VENTILATION OPENINGS.
- Slots and openings on the chassis are for ventilation. Do not block or cover these openings. Make sure you leave plenty of space around the device for ventilation. NEVER INSERT OBJECTS OF ANY KIND INTO THE VENTILATION OPENINGS.
- Use this product in environments with ambient temperatures $-20^{\circ}\text{C} \sim 60^{\circ}\text{C}$ for SSD, and $0^{\circ}\text{C} \sim 45^{\circ}\text{C}$ for HDD.
- DO NOT LEAVE THIS DEVICE IN AN ENVIRONMENT WHERE THE STORAGE TEMPERATURE MAY GO BELOW -20°C OR ABOVE 80°C . This could damage the device. The device must be used in a controlled environment.

Care for your iBASE products:

- Before cleaning the device, turn it off and unplug all cables such as power in case a small amount of electrical current may still flow.
- Use neutral cleaning agents or diluted alcohol to clean the device chassis with a cloth. Then wipe the chassis with a dry cloth.
- Vacuum the dust with a computer vacuum cleaner to prevent the air vent or slots from being clogged.



WARNING

Attention during use:

- Do not place heavy objects on the top of the device.
- Operate this device from the type of power indicated on the marking label. If you are not sure of the type of power available, consult your distributor or local power company.
- Do not walk on the power cord or allow anything to rest on it.
- If you use an extension cord, make sure that the total ampere rating of the product plugged into the extension cord does not exceed its limits.

Avoid Disassembly

Do not disassemble, repair or make any modification to the device. Disassembly, modification, or any attempt at repair could generate hazards and cause damage to the device, even bodily injury or property damage, and will void any warranty.



CAUTION

Danger of explosion if internal lithium-ion battery is replaced by an incorrect type. Replace only with the same or equivalent type recommended by the manufacturer. Dispose of used batteries according to the manufacturer's instructions.

Warranty Policy

- **IBASE standard products:**

IBASE offers a 24-month (2-year) warranty from the date of shipment. If the date of shipment cannot be ascertained, the product serial numbers can be used to determine the approximate shipping date.

- **3rd-party parts:**

12-month (1-year) warranty from delivery for the 3rd-party parts that are not manufactured by IBASE, such as CPU, memory, HDD, power adapter, panel and touchscreen.

* PRODUCTS, HOWEVER, THAT FAILS DUE TO MISUSE, ACCIDENT, IMPROPER INSTALLATION OR UNAUTHORIZED REPAIR SHALL BE TREATED AS OUT OF WARRANTY AND CUSTOMERS SHALL BE BILLED FOR REPAIR AND SHIPPING CHARGES.

Technical Support & Services

1. Visit the IBASE website at www.ibase.com.tw to find the latest information about the product.
2. If you need any further assistance from your distributor or sales representative, prepare the following information of your product and elaborate upon the problem.
 - Product model name
 - Product serial number
 - Detailed description of the problem
 - The error messages in text or in screenshots if there is any
 - The arrangement of the peripherals
 - Software in use (such as OS and application software, including the version numbers)
3. If repair service is required, you can download the RMA form at <http://www.ibase.com.tw/english/Supports/RMAService/>. Fill out the form and contact your distributor or sales representative.

Table of Contents

Chapter 1	General Information	1
1.1	Introduction	2
1.2	Features.....	3
1.3	Packing List	3
1.4	Optional Accessories	3
1.5	Specifications.....	4
1.6	Product View.....	6
1.7	Dimensions	10
Chapter 2	Hardware Configuration	12
2.1	Installations.....	13
2.1.1	HDD Installation.....	13
2.1.2	M.2 Card Installation.....	14
2.1.3	Memory Installation	15
2.1.4	WiFi / 4G / 5G Antenna Installation.....	16
2.1.5	Side Bracket Installation	17
2.1.6	Pinout for COM Ports, DC Power & Digital I/O Connectors.....	18
2.2	Setting the Jumpers	20
2.3	Jumper & Connector Locations on IB953.....	21
2.4	Jumpers Quick Reference.....	22
2.4.1	Clear CMOS Data (JP1).....	22
2.4.2	EDP Panel Power Selection (JP2).....	23
2.4.3	eDP Power Selections (JP4).....	23
2.4.4	AT / ATX Selection (JP6).....	24
2.4.5	LVDS Panel Power / Brightness Selections (JP5 / JP7).....	24
2.5	Connectors Quick Reference	25
2.5.1	SATA Connectors (CN1, CN3)	26
2.5.2	eDP Connector (CN2).....	27
2.5.3	COM1 Serial Port (CN4)	28
2.5.4	DP Connectors (CN8, CN9).....	29
2.5.5	Audio Connector (J2).....	30
2.5.6	Audio AMP Connector (J4).....	31
2.5.7	USB2 #5 #6 (J6).....	32
2.5.8	DC-In Connector (J7).....	32
2.5.9	LVDS CHB Connector (J12 - 2nd, J14 - 1st).....	33
2.5.10	SATA Power Connector (J13).....	34
2.5.11	LVDS Backlight Connector (J15)	34

2.5.12	Digital I/O Connector (J17)	35
2.5.13	Front Panel Setting Connector (J18).....	36
2.5.14	COM2 Serial Ports (J19).....	37
2.5.15	CPU Fan Power Connector (CPU_FAN1).....	38
Chapter 3	Driver Installation	39
3.1	Introduction	40
3.2	Intel® Chipset Software Installation Utility	40
3.3	VGA Driver Installation.....	42
3.4	HD Audio Driver Installation	43
3.5	LAN Driver Installation	44
3.6	Intel® Management Engine Drivers Installation.....	46
3.7	Intel® Thunderbolt Drivers Installation	48
Chapter 4	BIOS Setup	50
4.1	Introduction	51
4.2	BIOS Setup.....	51
4.3	Main Settings	52
4.4	Advanced Settings	53
4.5	Chipset Settings.....	68
4.6	Security Settings	72
4.7	Boot Settings.....	73
4.8	Save & Exit Settings.....	74
Appendix	75
A.	I/O Port Address Map.....	76
B.	Interrupt Request Lines (IRQ)	78
C.	Watchdog Timer Configuration.....	79

Chapter 1

General Information

The information provided in this chapter includes:

- Features
- Packing List
- Optional Accessories
- Specifications
- Product View
- Dimensions

1.1 Introduction

The ASB200-953 compact box PC housing IBASE's IB953 3.5-inch SBC powered by Intel® Core™ processors with a 15W TDP threshold. Aimed at smart applications in warehouse logistics management, factory automation and the automotive industry, the ASB200-953 features high performance with low power consumption. With black chassis color, it supports up to 64GB in two SO-DIMM slots and 12V~24V wide-range DC power input. Useful I/O ports on the front side include 3x USB 3.1, 1x USB 2.0, 2x DisplayPort, 1x COM, and 2x GbE ports. The rear panel is equipped with digital I/O, power button, HDD LED, DC-in terminal block and two antenna holes that can be used with the optional WiFi accessory kit. The ASB210-953 variant comes with fan support and TDP up to 28W.



ASB200-953



ASB210-953

1.2 Features

- System with IBASE IB953 3.5-inch SBC (TDP 15W for ASB200-953, 28W TDP for ASB210-953)
- Onboard 11th Gen Intel® Core™ U-Series Processor
- Supports 3x M.2 sockets (B-Key/E-Key and M-Key)
- 12V (-10%) ~ 24V (+10%) DC-in power input
- 2x DDR4-3200 SO-DIMM, Max. 64GB
- 3x USB 3.1, 1x USB 2.0, 2x Intel® GbE, 1x COM
- External GPIO, 2x DisplayPort, TPM (2.0)
- Optional VESA mount bracket

1.3 Packing List

Your product package should include the items listed below. If any of the items below is missing, contact the distributor or the dealer from whom you purchased the product.

- | | |
|--|-----|
| • ASB200-953 or ASB210-953 | x 1 |
| • 3-pin Terminal Block (for power) | x 1 |
| • 10-pin Terminal Block (for GPIO connector) | x 1 |
| • Side Brackets | x 1 |
| • Screws for Side Brackets | x 4 |
| • Screws for M key and E key M.2 | x 2 |
| • Power Adaptor and Power Cord | x 1 |

1.4 Optional Accessories

- WiFi / Bluetooth Module Kit

1.5 Specifications

Product Name	ASB210-953-i7M	ASB210-953-i5M	ASB200-953-i3M
Motherboard	IB953AF-i7	IB953AF-i5	IB953F-i3
System			
CPU	Intel® Core™ i7-1185G7E	Intel® Core™ i5-1145G7E	Intel® Core™ i3-1115G4E
Memory	2 x DDR4-3200 SO-DIMM, Max. 64 GB		
Storage	1 x M.2 M-key 2280, 1x 2.5" HDD or SSD		
Power Supply	90W power adaptor		
BIOS	AMI BIOS		
Watchdog	Watchdog Timer 256 segments, 0, 1, 2...255 sec/min		
Mounting	<ul style="list-style-type: none"> • Desktop or wall mount • VESA mount (optional) 		
Dimensions	180mm (W) x 150mm (D) x 72mm (H) 7.08" (W) x 5.9" (D) x 2.83" (H)		
Weight	1.5 kg		
Certificate	CE / LVD / FCC Class B		
I/O Ports			
Front I/O	<ul style="list-style-type: none"> • 3x USB 3.1 • 1x USB 2.0 • 2x DisplayPort • 1x DB9 for COM#1 (RS232/422/485) • 2x LAN 		
Rear I/O	<ul style="list-style-type: none"> • 1x Power button • 1x Digital I/O (4-in/4-out) • 2x Antenna holes • 1x HDD LED • 1x 3-pin DC-in terminal block for 12V (-10%) ~ 24V (+10%) 		
Expansion	<ul style="list-style-type: none"> • 3x M.2 sockets (B-Key/ E-Key and M-Key) 		

Environment	
Temperature	<ul style="list-style-type: none"> • Operating: 0 ~ 45 °C (32 ~ 113 °F) • Storage: -20~ 80 °C (-4 ~ 176 °F)
Relative Humidity	5 ~ 90% at 45 °C (non-condensing)
Vibration Protection	<ul style="list-style-type: none"> • Operating: 0.25 Grms / 5 ~ 500 Hz • Non-operating: 1 Grms / 5 ~ 500Hz
Shock Protection	<ul style="list-style-type: none"> • Operating: 20 g / 11 ms • Non-operating: 40 g / 11 ms

All specifications are subject to change without prior notice.

1.6 Product View

Front View

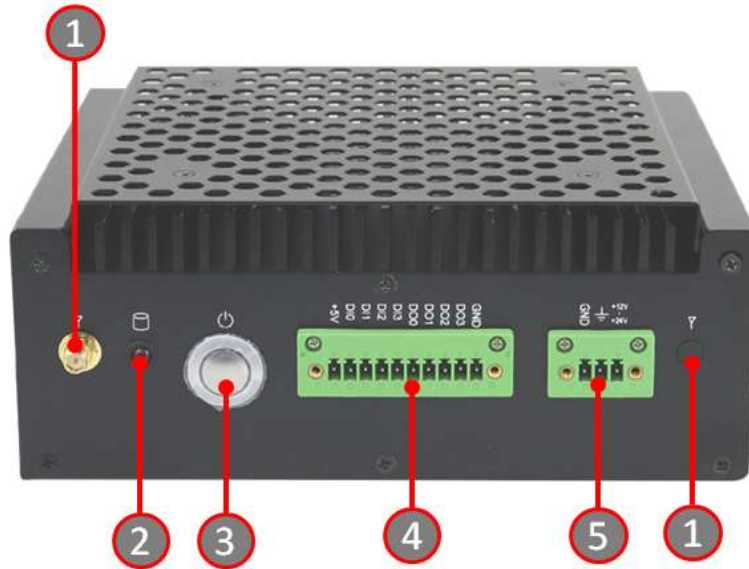

ASB200-953



ASB210-953

No.	Name	No.	Name
1	Antenna Holes	4	Digital I/O (4-In / 4-Out)
2	HDD LED	5	DC +12V~ +24V Power Input
3	Power Switch		

Rear View

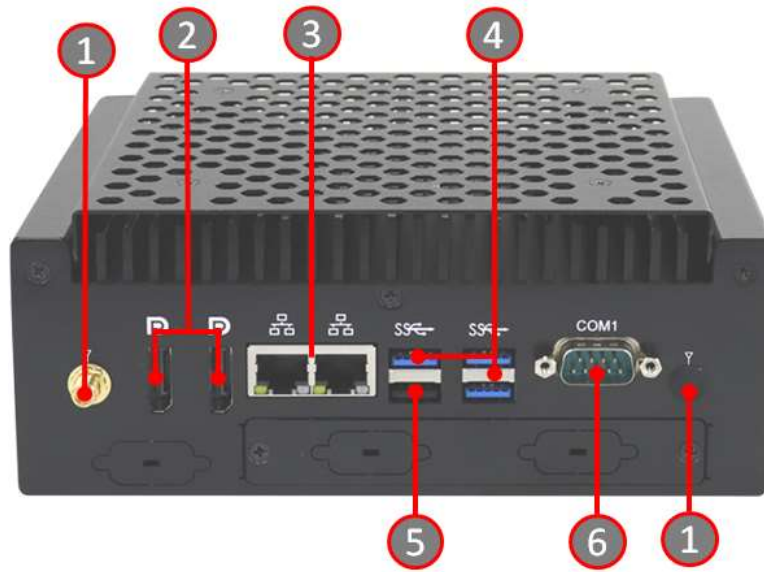

ASB200-953

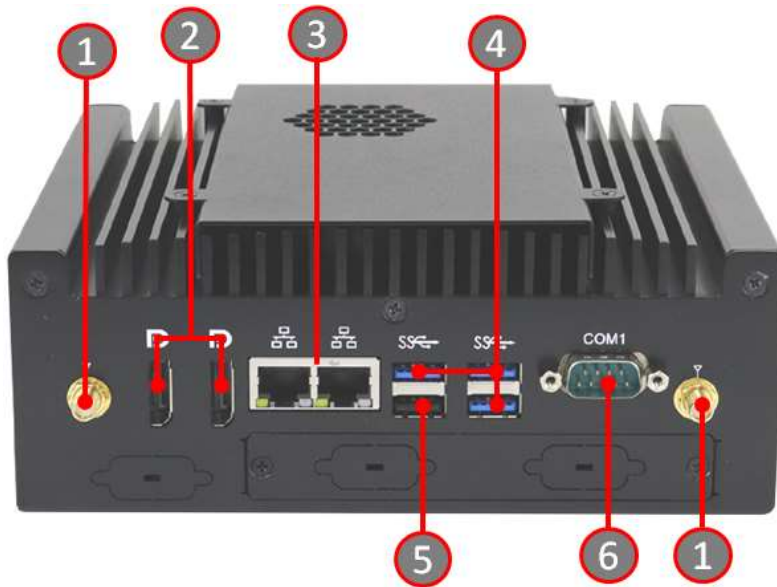

ASB210-953

No.	Name	No.	Name
1	Antenna Holes	4	USB 3.1 Ports
2	Display Port	5	USB 2.0 Port
3	LAN Ports	6	COM Port

Oblique View



ASB200-953



ASB210-953

1.7 Dimensions

Unit: mm

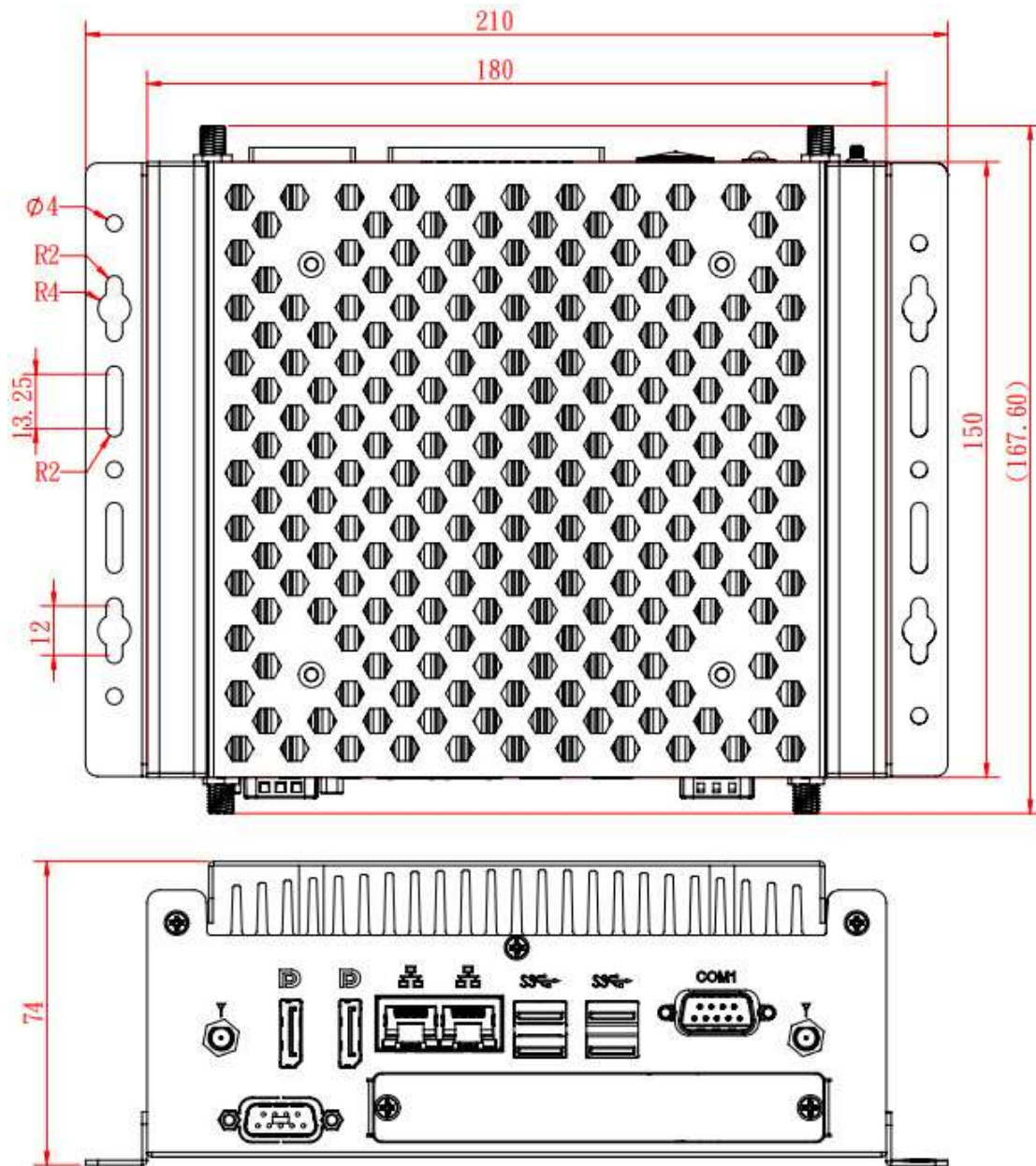

ASB200-953

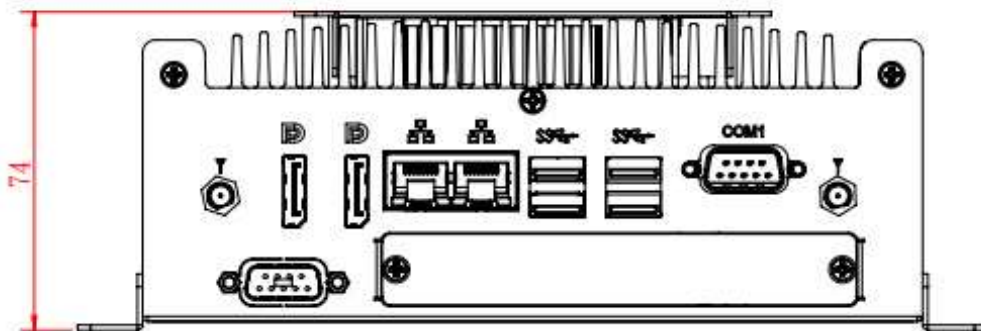
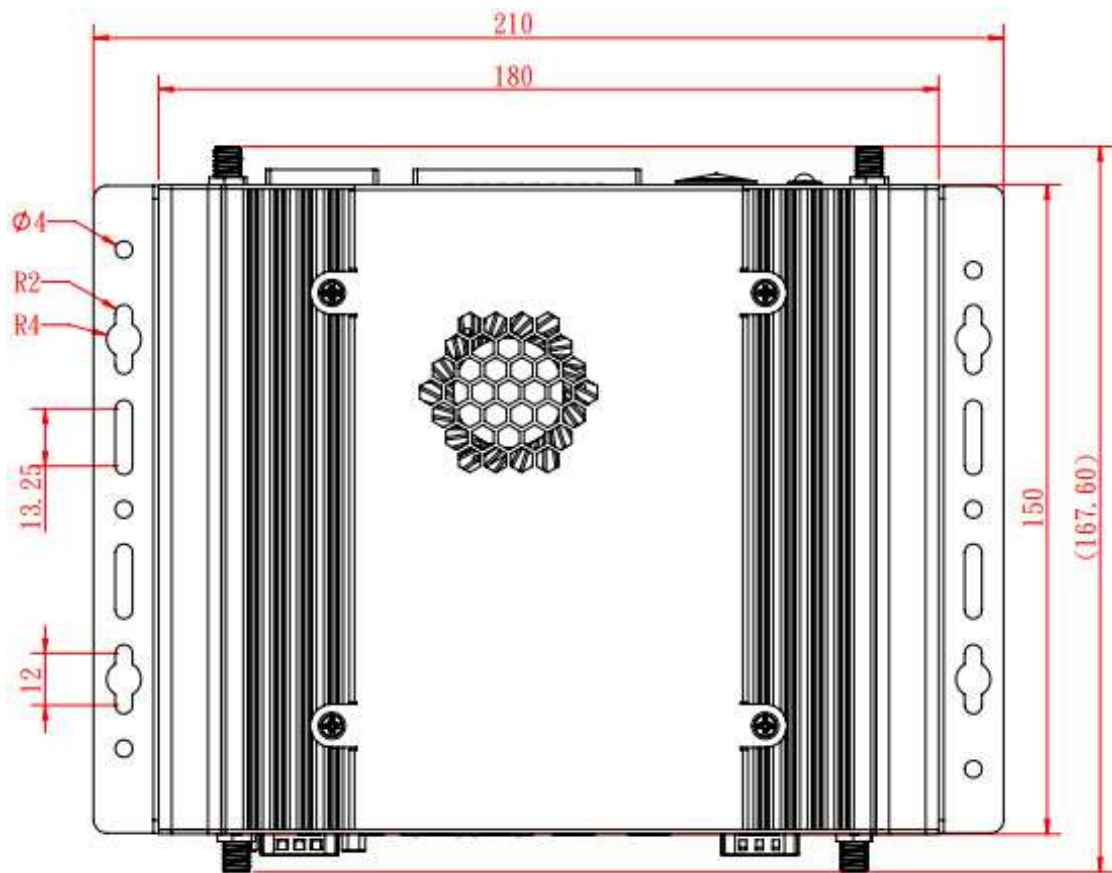

ASB210-953

Chapter 2

Hardware Configuration

The information provided in this chapter includes:

- Installations
- Descriptions and locations of connectors

2.1 Installations

2.1.1 HDD Installation

If you need to install or replace an SSD or a HDD, follow the instructions below.

1. Remove the screws shown below to remove/install the SDD/HDD tray and the SSD/HDD drive.

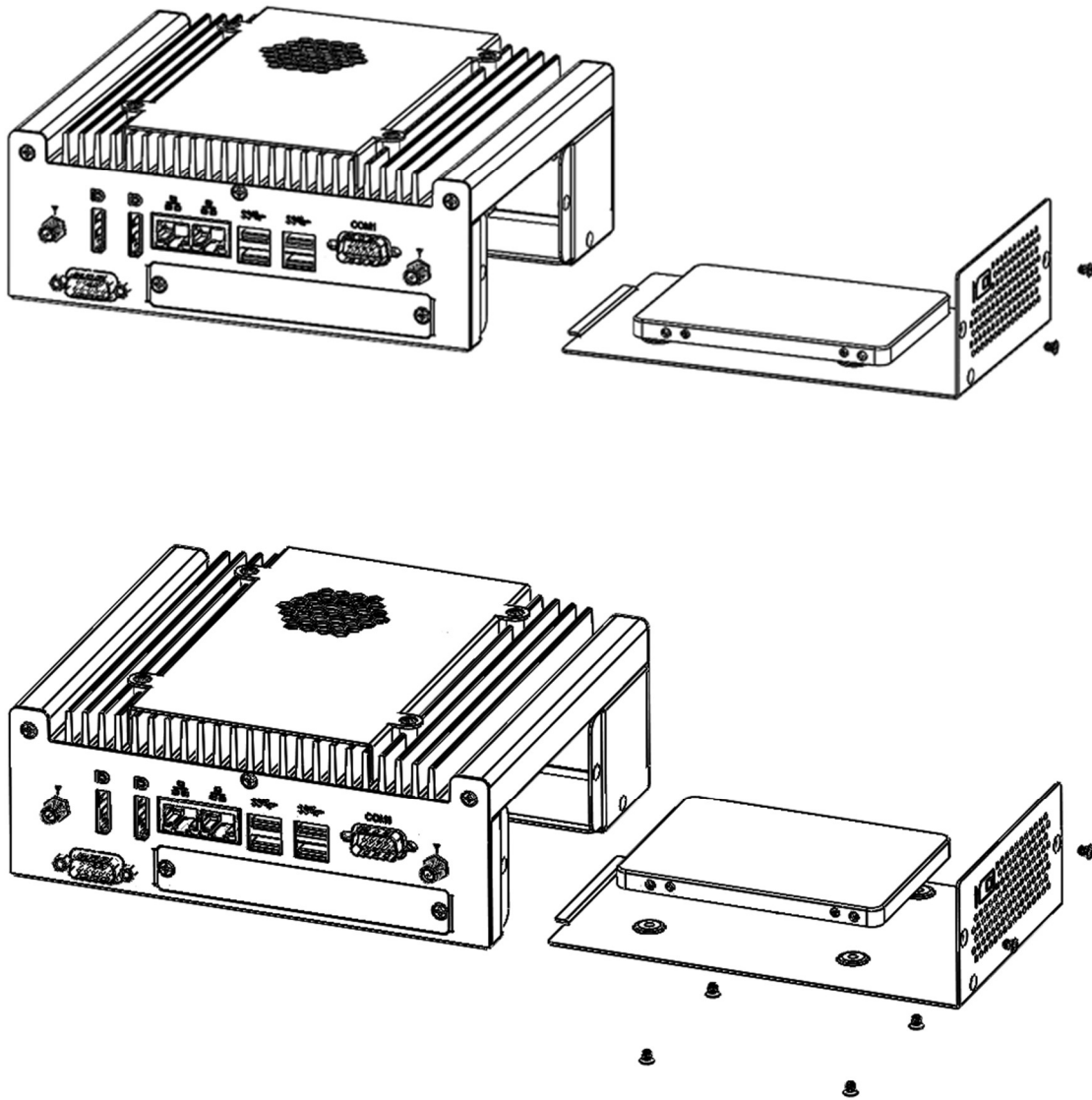

2.1.2 M.2 Card Installation

1. Remove all the screws on the front and rear panel in order to loosen the heatsink kit with the main board.
2. After removing the heatsink with the board, turn it upside down and remove the screws holding the cover plate in order to access the parts on the main board such as the M.2 card slot and the memory socket as shown below.

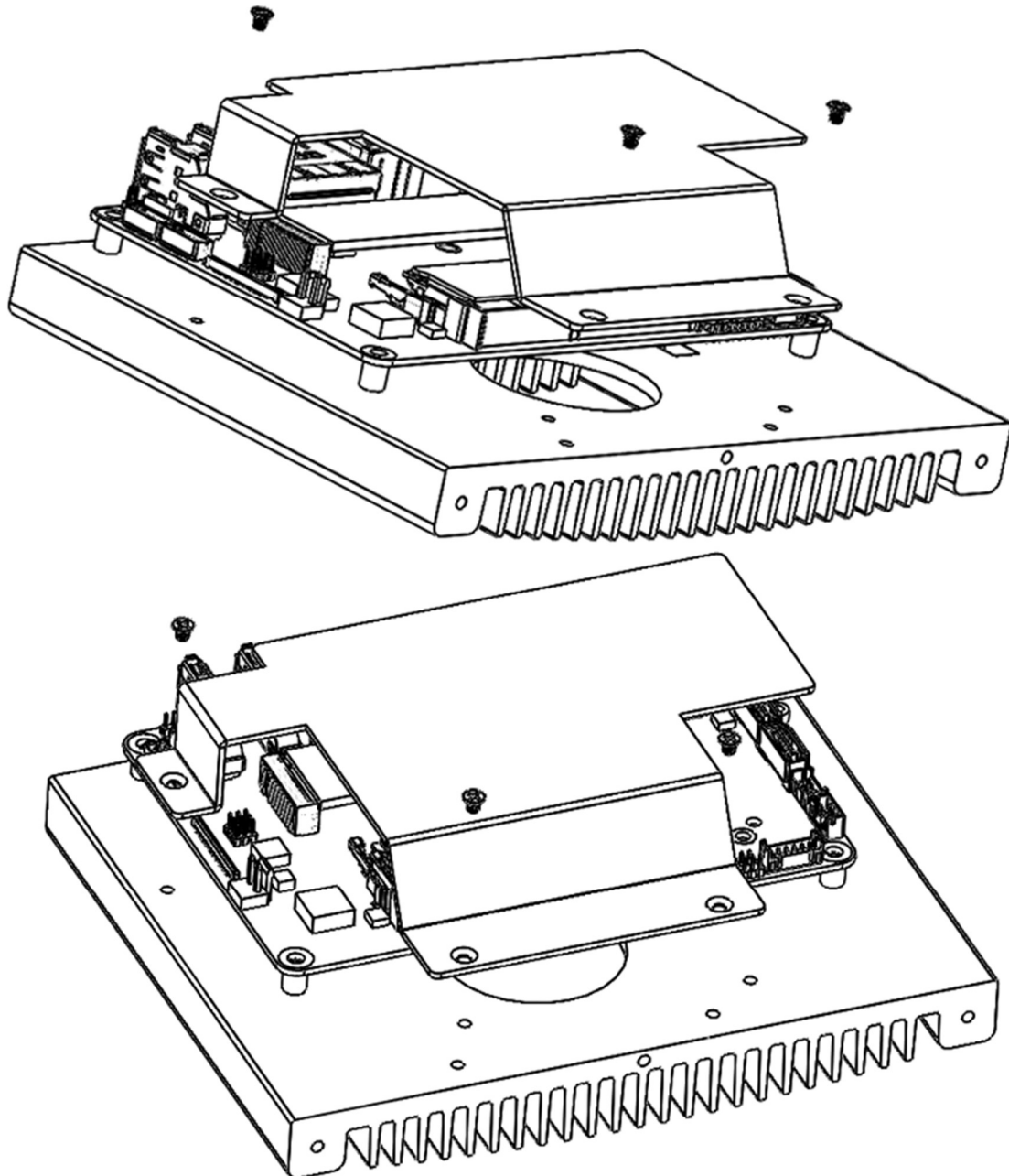

3. Locate the M.2 card slot. Align the key of the m.2 card to the m.2 interface, and insert the card slantwise.

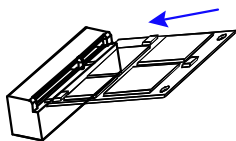

4. Push the m.2 card down, and fix it onto the standoff with a screw.

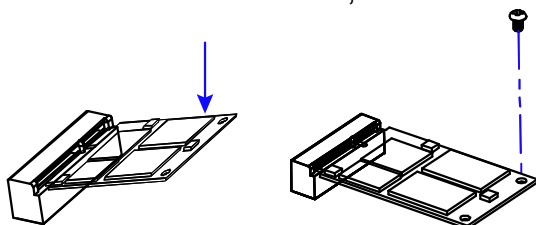

2.1.3 Memory Installation

If you need to install or replace a memory module, perform the following steps:

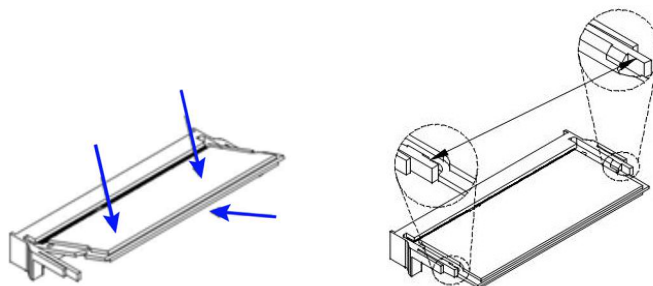

1. Locate the memory slot on the board.
2. Align the key of the memory module with that on the memory slot and insert the module slantwise.
3. Gently push the module down in an upright position until the clips of the slot close to hold the module in place when the module touches the bottom of the slot.

To remove the module, press the clips outwards with both hands, and the module will pop-up.

2.1.4 WiFi / 4G / 5G Antenna Installation

Thread the WiFi / 4G / 5G antenna cable through an antenna hole. Then fasten the antenna as shown below.

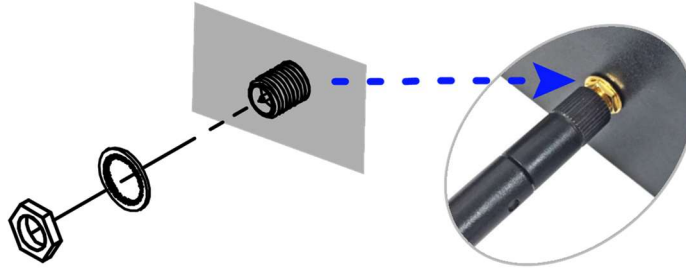

Info: The diameter of the nut is around 6.35 mm (0.25"-36UNC).

2.1.5 Side Bracket Installation

Use the screws provided in the accessory kit to lock the case together with the bracket

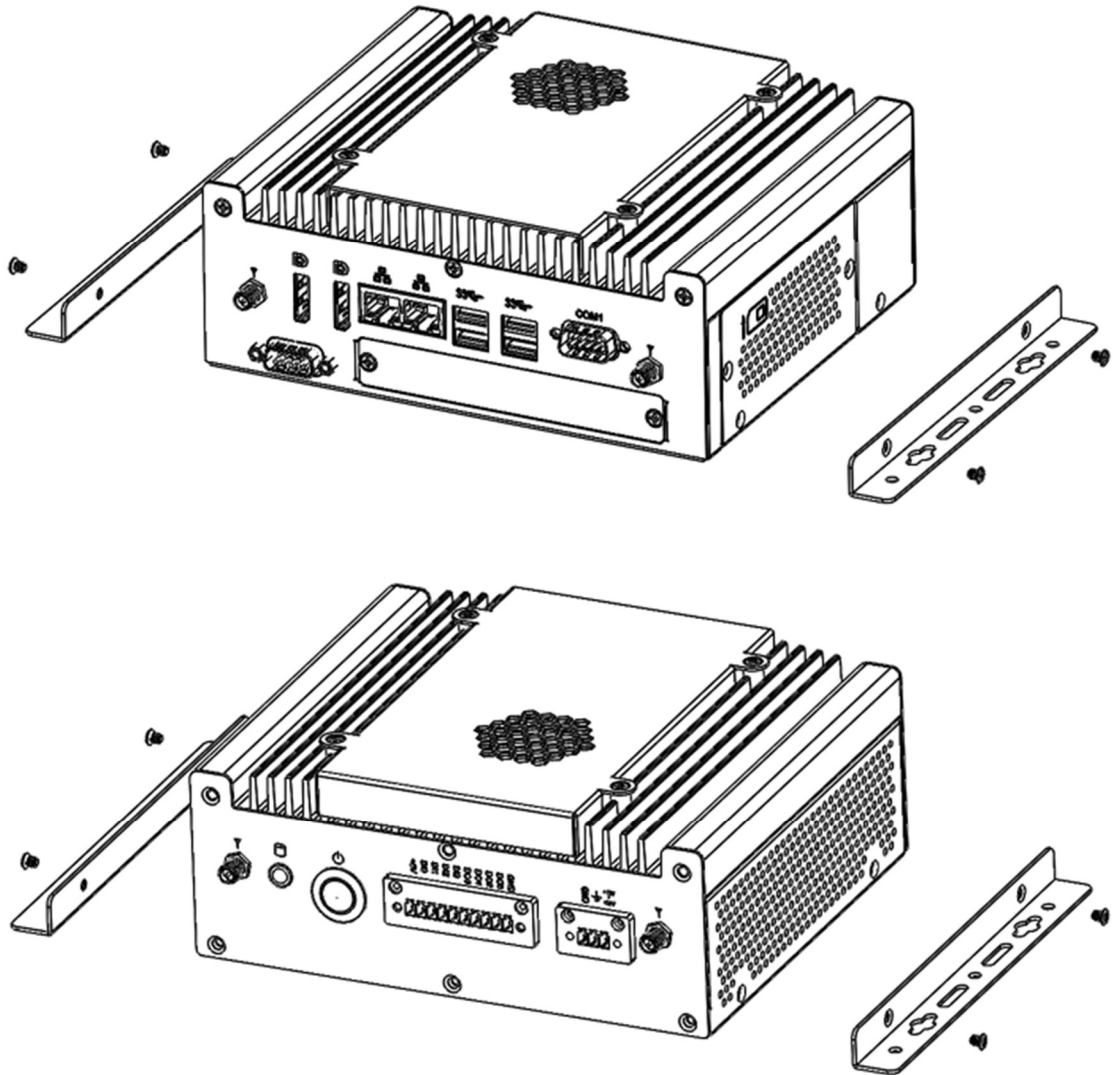

2.1.6 Pinout for COM Ports, DC Power & Digital I/O Connectors

- COM1 RS232/422/485 Port**

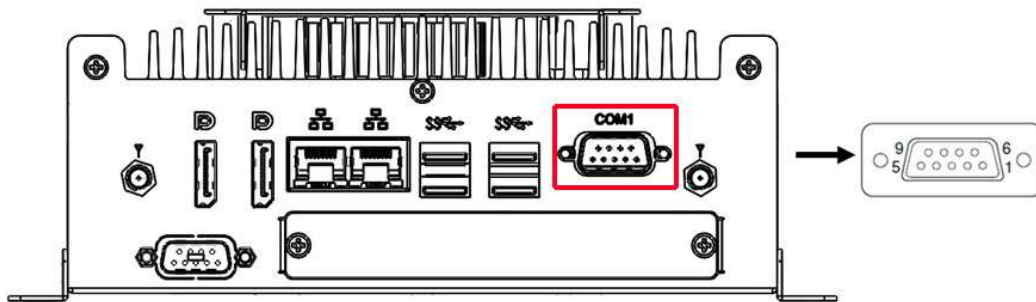

Pin	Assignment	Pin	Assignment
1	DCD, Data carrier detect	6	DSR, Data set ready
2	RXD, Receive data	7	RTS, Request to send
3	TXD, Transmit data	8	CTS, Clear to send
4	DTR, Data terminal ready	9	RI, Ring indicator
5	Ground		

Pin	Assignment		
	RS-232	RS-422	RS-485
1	DCD	TX-	DATA-
2	RX	TX+	DATA+
3	TX	RX+	NC
4	DTR	RX-	NC
5	Ground	Ground	Ground
6	DSR	NC	NC
7	RTS	NC	NC
8	CTS	NC	NC
9	RI	NC	NC

- DC Power Input Connector (terminal block)

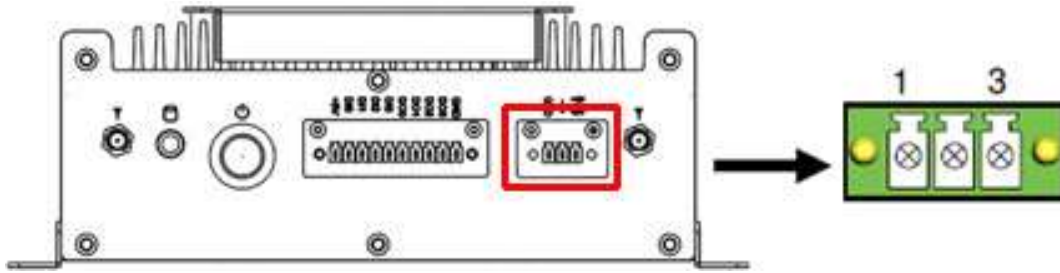

Pin	Assignment	Pin	Assignment
1	Ground	3	+12V ~ +24V
2	Chassis Ground		

- Digital I/O Connector (terminal block)

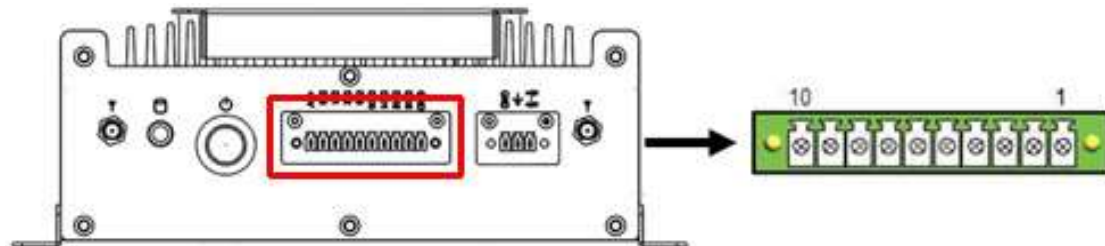

Pin	Assignment	Pin	Assignment
1	Ground	6	DI3
2	DO3	7	DI2
3	DO2	8	DI1
4	DO1	9	DI0
5	DO0	10	+5V

2.2 Setting the Jumpers

Set up and configure your product by using jumpers for various settings and features according to your needs and applications. Contact your supplier if you have doubts about the best configuration for your use.

2.2.1 How to Set Jumpers

Jumpers are short-length conductors consisting of several metal pins with a non-conductive base mounted on the circuit board. Jumper caps are used to have the functions and features enabled or disabled. If a jumper has 3 pins, you can connect either PIN1 to PIN2 or PIN2 to PIN3 by shorting.

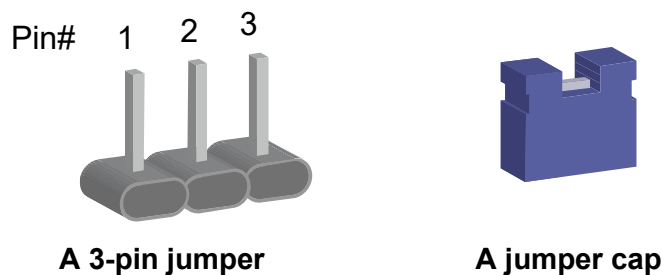

Refer to the illustration below to set jumpers.

Pin closed	Oblique view	illustration
Open		
1-2		
2-3		

When two pins of a jumper are encased in a jumper cap, this jumper is **closed**, i.e. turned **On**.

When a jumper cap is removed from two jumper pins, this jumper is **open**, i.e. turned **Off**.

2.3 Jumper & Connector Locations on IB953

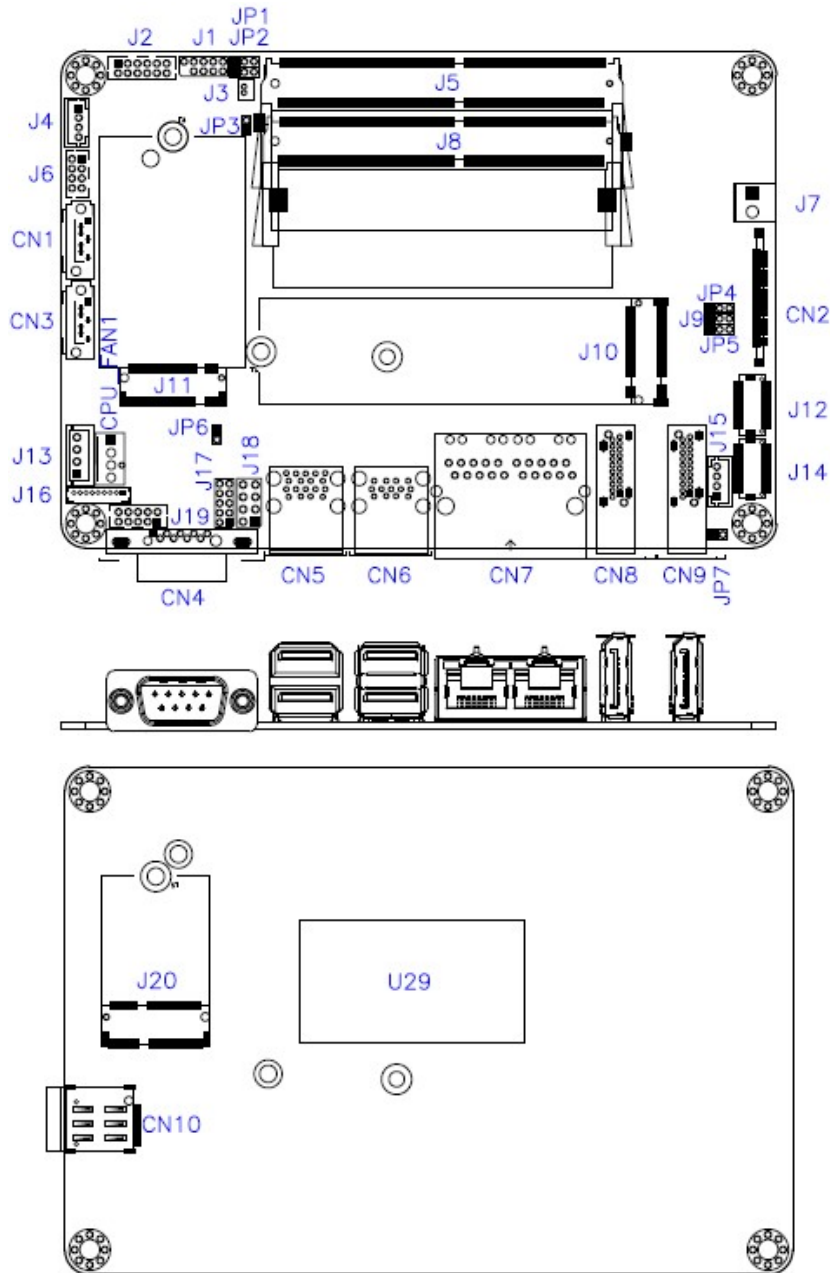

2.4 Jumpers Quick Reference

Function	Jumper
Clear RTC Data	JP1
Clear CMOS Data	JP2
eDP Power Selection	JP4
LVDS Power Selection	JP5
AT/ATX Selection	JP6
LVDS Panel Power / Brightness Selections	JP5 (For power) JP7 (For brightness)

2.4.1 Clear CMOS Data (JP1)

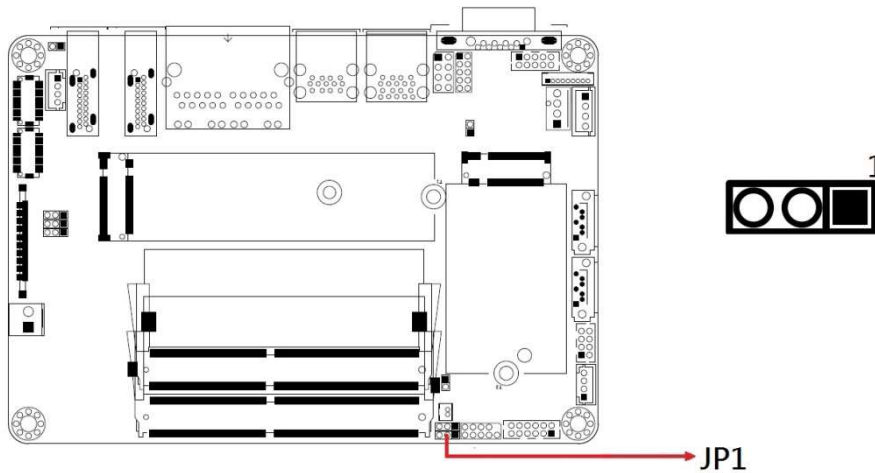

Function	Pin closed	Setting
Normal (default)	1-2	1
Clear RTC	2-3	1

2.4.2 EDP Panel Power Selection (JP2)

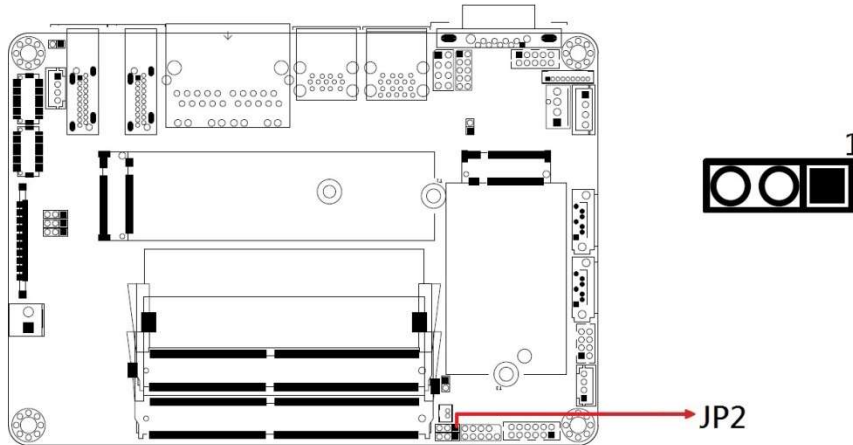

Function	Pin closed	Setting
Normal (default)	1-2	1
Clear CMOS	2-3	1

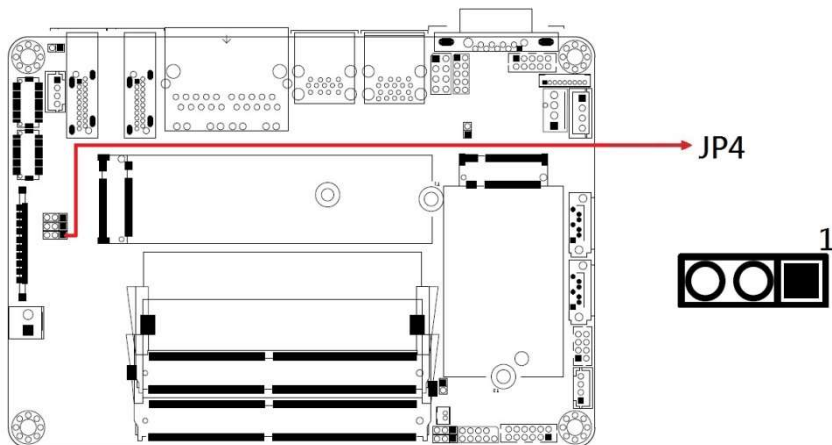

2.4.3 eDP Power Selections (JP4)



Function	Pin closed	Setting
3.3V (default)	1-2	1
5V	2-3	1

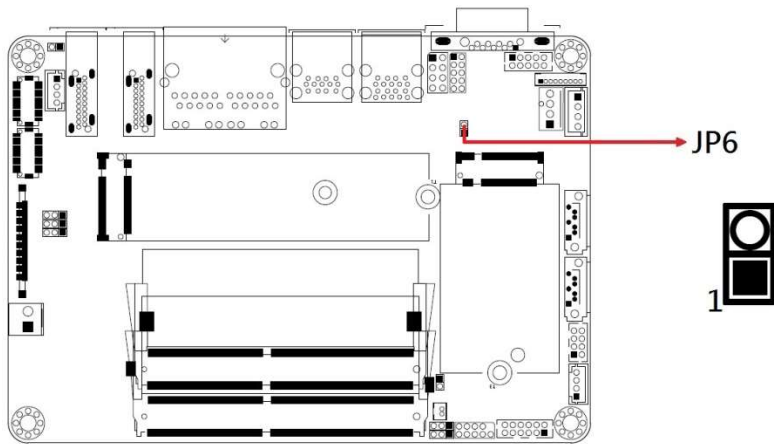



2.4.4 AT / ATX Selection (JP6)

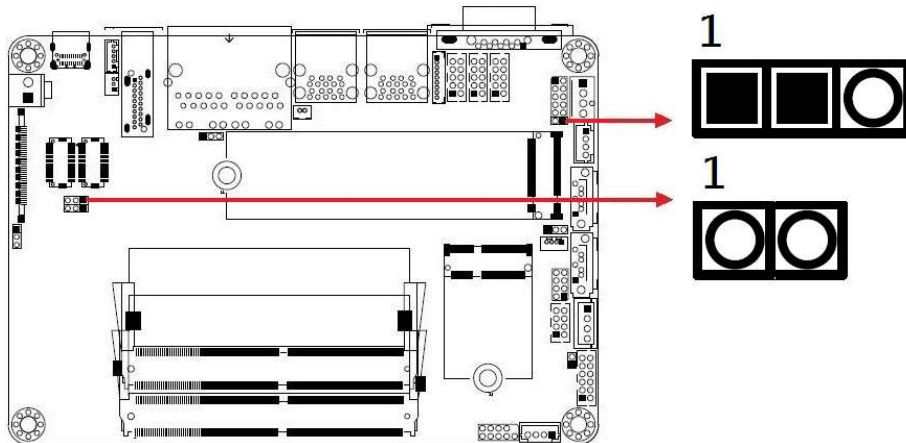

Function	Pin closed	Setting
ATX	Open	1 
AT	Close	1 

2.4.5 LVDS Panel Power / Brightness Selections (JP5 / JP7)



Jumper	Function	Pin closed	Setting
JP5	3.3V (default)	1-2	1 
	5V	2-3	1 
JP7	3.3V (default)	Open	1 
	5V	Close	1 

2.5 Connectors Quick Reference

Function	Connector
SPI Flash Connector (factory use only)	J1
Battery Connector	J3
DDR4 UDIMM CH-A	J5
DDR4 UDIMM CH-B	J8
M.2 M-Key 2280	J10
M.2 B-Key 3052	J11
LVDS CH-B	J12
eSPI Debug (Factory use only)	J16
M.2 E-Key with CNVi	J20
SIM Socket	CN10
SATA Connectors	CN1, CN3
eDP Connector	CN2
COM1 Serial Port	CN4
DP Connectors	CN8, CN9
Audio Connector	J2
Audio AMP Connector	J4
USB2 #5 #6	J6
DC-In Connector	J7
LVDS CHB Connector (1st, 2nd)	J14, J12
SATA Power Connector	J13
LVDS Backlight Connector	J15
Digital I/O Connector	J17
Front Panel Setting Connector	J18
COM2 Serial Ports	J19
CPU Fan Power Connector	CPU_FAN1

2.5.1 SATA Connectors (CN1, CN3)

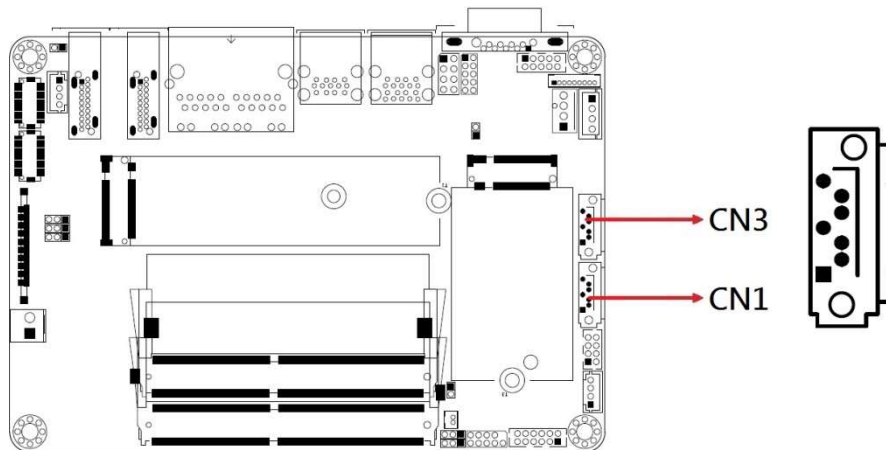

Pin	Assignment	Pin	Assignment
1	Ground	5	RX-
2	TX+	6	RX+
3	TX-	7	Ground
4	Ground		

2.5.2 eDP Connector (CN2)

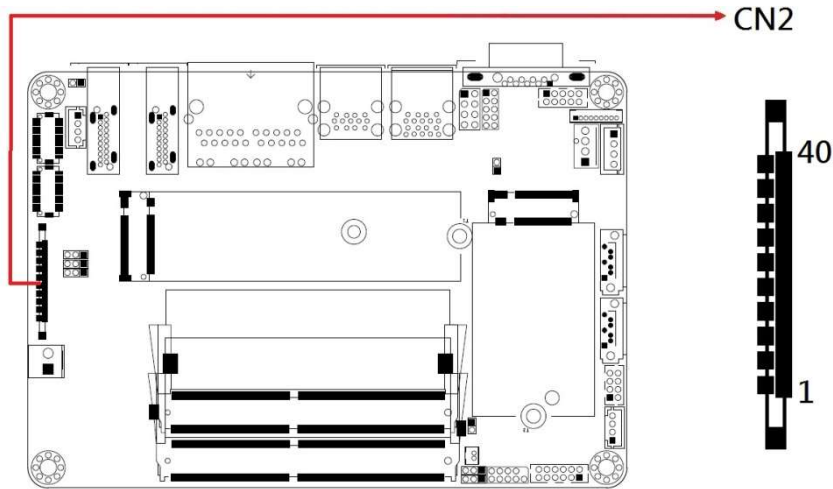

Remarks: KEL_SSL00-40S

Pin	Assignment	Pin	Assignment
1	eDP Vcc	21	TXN0
2	eDP Vcc	22	TXP1
3	eDP Vcc	23	Ground
4	eDP Vcc	24	AUXP
5	eDP Vcc	25	AUXN
6	Ground	26	NC
7	Ground	27	+3.3V
8	Ground	28	EDP BKLT (+12V)
9	Ground	29	NC
10	Hot Plug detect	30	Ground
11	Ground	31	+5V
12	TXN3	32	NC
13	TXP3	33	Back Light Control
14	Ground	34	Back Light Enable
15	TXN2	35	EDP BKLT (+12V)
16	TXP2	36	+3.3V
17	Ground	37	Ground
18	TXN1	38	NC
19	TXP1	39	NC
20	Ground	40	NC

2.5.3 COM1 Serial Port (CN4)

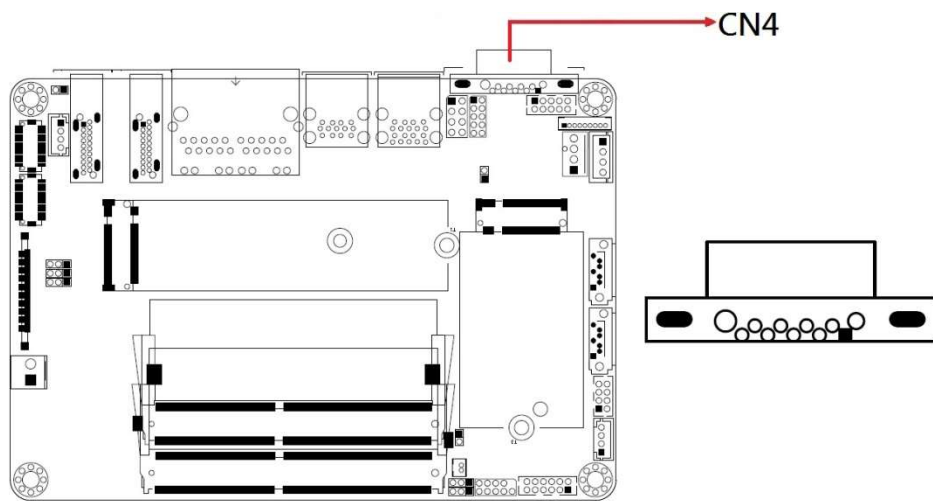

Pin	Assignment		
	RS-232	RS-422	RS-485
1	DCD	TX-	DATA-
2	RX	TX+	DATA+
3	TX	RX+	NC
4	DTR	RX-	NC
5	Ground	Ground	Ground
6	DSR	NC	NC
7	RTS	NC	NC
8	CTS	NC	NC
9	RI	NC	NC
10	NC	NC	NC

2.5.4 DP Connectors (CN8, CN9)

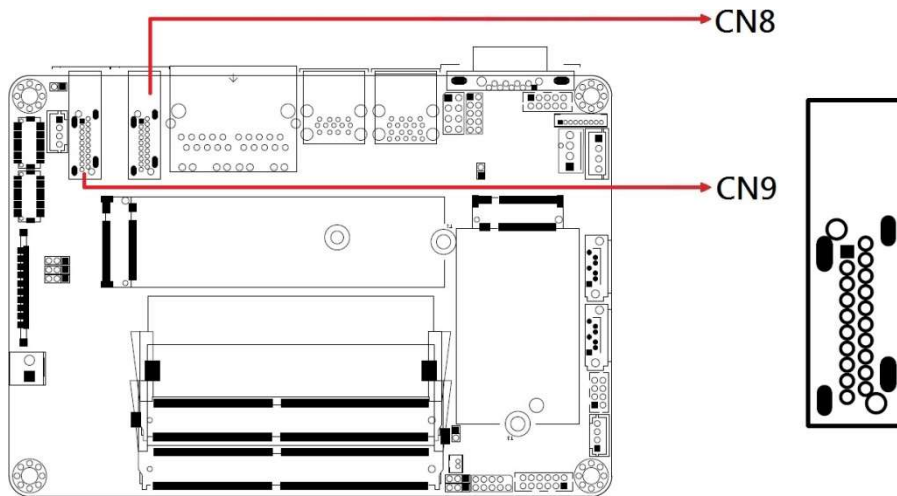

Pin	Assignment	Pin	Assignment
1	LAN0_P	11	GND
2	GND	12	LAN3_N
3	LAN0_N	13	CONFIG
4	LAN1_P	14	GND
5	GND	15	AUXP
6	LAN1_N	16	GND
7	LAN2_P	17	AUXN
8	GND	18	Hot Plug
9	LAN2_N	19	GND
10	LAN3_P	20	+5V

2.5.5 Audio Connector (J2)

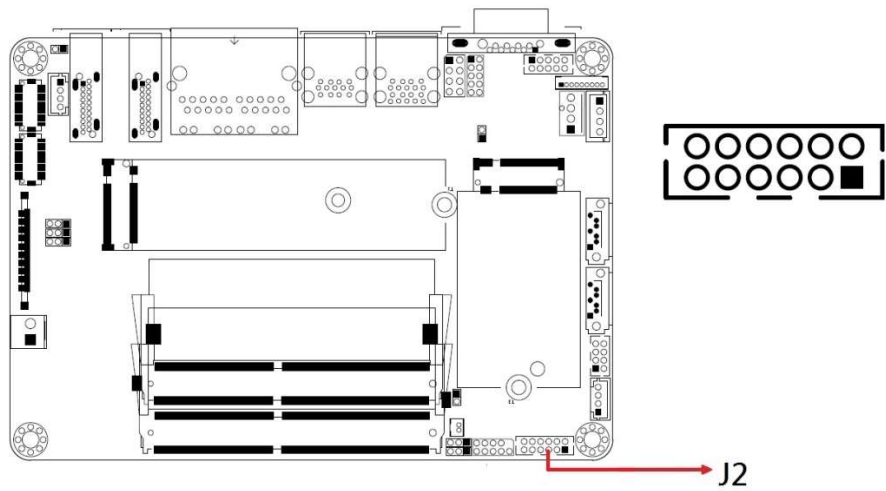

Remarks: HK_DF11-12S-PA66H

Pin	Assignment	Pin	Assignment
1	LINE OUT_L	2	LINE OUT_R
3	FRONT_JD	4	GND
5	LINE IN_L	6	LINE IN_R
7	LINE_JD	8	GND
9	MIC_L	10	MIC_R
11	MIC_JD	12	GND

2.5.6 Audio AMP Connector (J4)

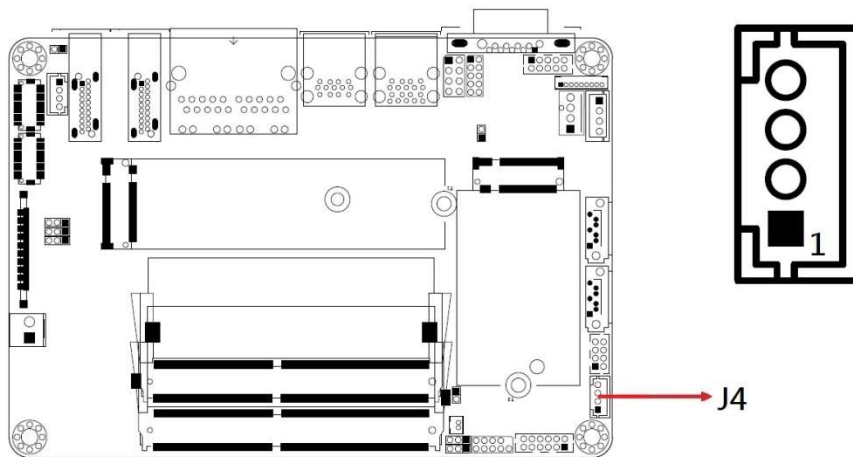

Remarks: E-CALL_0110-161-040

Pin	Assignment
1	SPK_L+
2	SPK_L-
3	SPK_R-
4	SPK_R+

2.5.7 USB2 #5 #6 (J6)

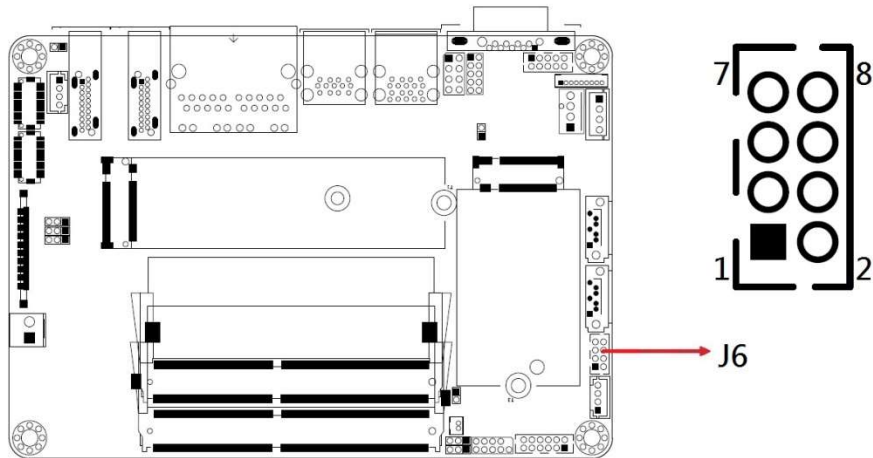

Remarks: HK_DF11-8S-PA66H

Pin	Assignment	Pin	Assignment
1	+5V	2	GND
3	USB_PN	4	USB_PP
5	USB_PP	6	USB_PN
7	GND	8	+5V

2.5.8 DC-In Connector (J7)

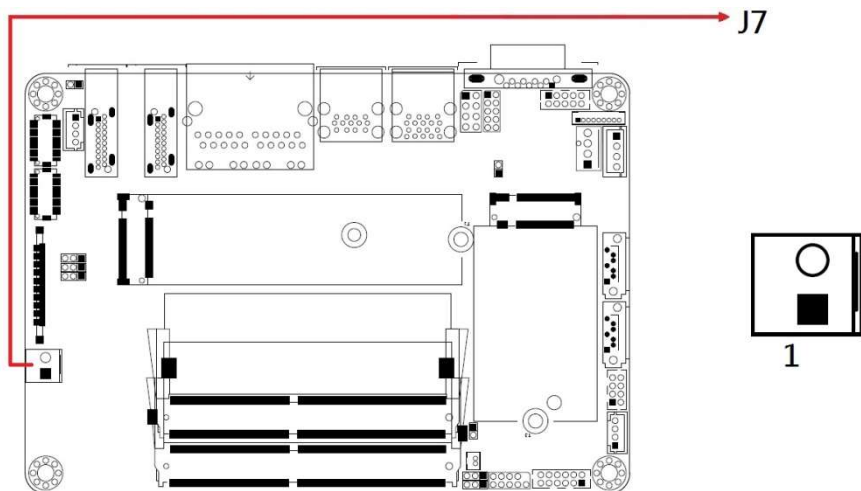

Pin	Assignment
1	+12 ~ +24V
2	Ground

2.5.9 LVDS CHB Connector (J12 - 2nd, J14 - 1st)

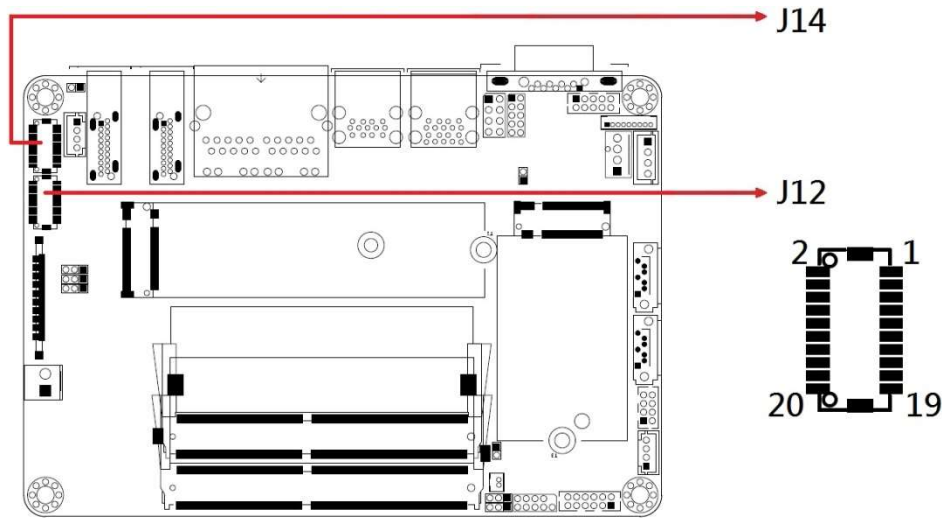

Remarks: HIROSE_DF20G-20DP-1V(56)

Pin	Assignment	Pin	Assignment
1	TX0P	2	TX0N
3	GND	4	GND
5	TX1P	6	TX1N
7	GND	8	GND
9	TX2P	10	TX2N
11	GND	12	GND
13	CLKP	14	CLKN
15	GND	16	GND
17	TX3P	18	TX3N
19	+3.3V	20	+3.3V

2.5.10 SATA Power Connector (J13)

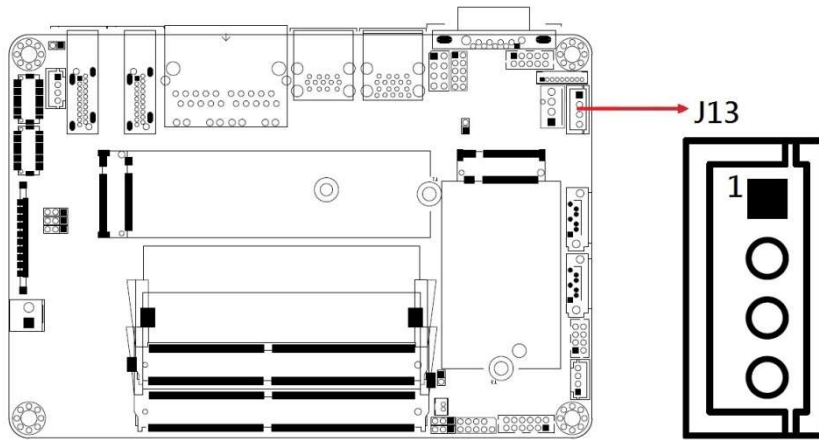

Remarks: E-CALL_0110-071-040

Pin	Assignment
1	+5V
2	GND
3	GND
4	+12V

2.5.11 LVDS Backlight Connector (J15)

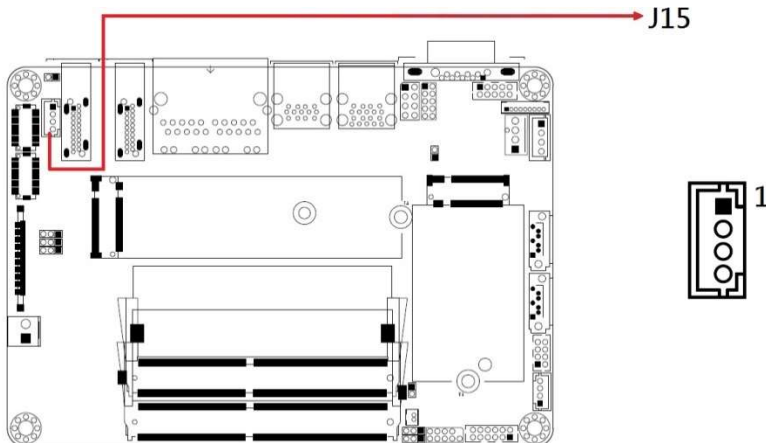

Remarks: E-CALL_0110-161-040

Pin	Assignment
1	+12V
2	Backlight Enable
3	Brightness Control
4	Ground

2.5.12 Digital I/O Connector (J17)

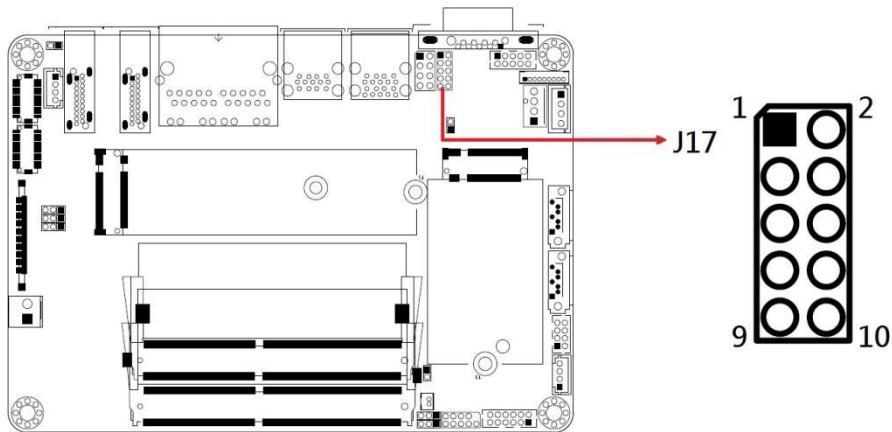

Remarks: E-CALL_0196-01-200-100

Pin	Assignment	Pin	Assignment
1	Ground	2	+5V
3	Out3	4	Out1
5	Out2	6	Out0
7	IN3	8	IN1
9	IN2	10	IN0

2.5.13 Front Panel Setting Connector (J18)

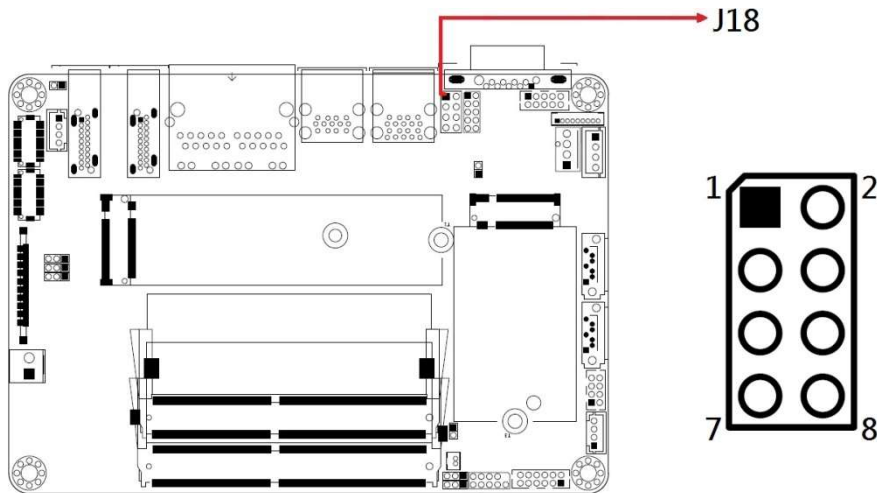

* E-CALL_0126-01-203-080

Pin	Assignment	Pin	Assignment
1	Power BTN	2	Power BTN
3	HDD LED+	4	HDD LED-
5	Reset BTN	6	Reset BTN
7	Power LED+	8	Power LED-

This connector is utilized for system indicators to provide light indication of the computer activities and switches to change the computer status. It provides interfaces for the following functions.

- ATX Power ON Switch (Pins 1 and 2)**

This is the “ATX Power Supply On/Off Switch” for the system that connects to the power switch on the case. When pressed, the power switch will force the system to power on. When pressed again, it will power off the system.
- Hard Disk Drive LED Connector (Pins 3 and 4)**

This connector connects to the hard drive activity LED on control panel. This LED will flash when the HDD is being accessed.
- Reset Switch (Pins 5 and 6)**

The reset switch allows you to reset the system without turning the main power switch off and then on again. Orientation is not required when making a connection to this header.
- Power LED: Pins 7 and 8**

This connector connects to the system power LED on control panel. This LED will light when the system turns on.

2.5.14 COM2 Serial Ports (J19)

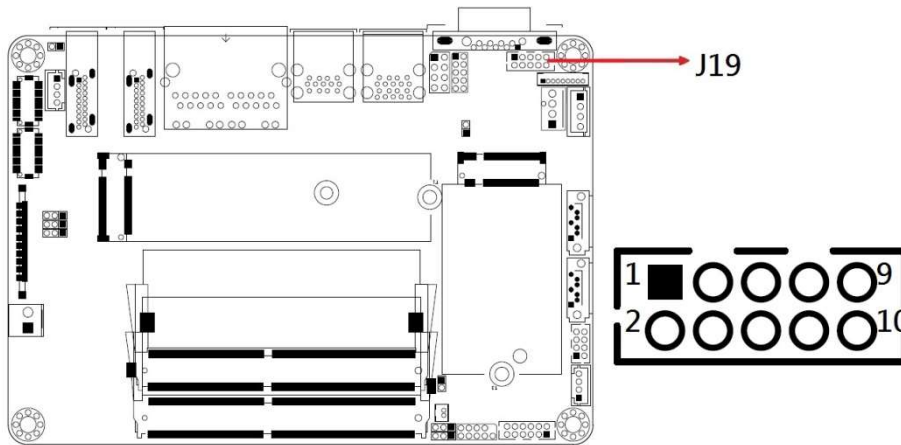

Remarks: HK_DF11-10S-PA66H

Pin	Assignment		
	RS-232	RS-422	RS-485
1	DCD	TX-	DATA-
2	RX	TX+	DATA+
3	TX	RX+	NC
4	DTR	RX-	NC
5	Ground	Ground	Ground
6	DSR	NC	NC
7	RTS	NC	NC
8	CTS	NC	NC
9	RI	NC	NC
10	NC	NC	NC

2.5.15 CPU Fan Power Connector (CPU_FAN1)

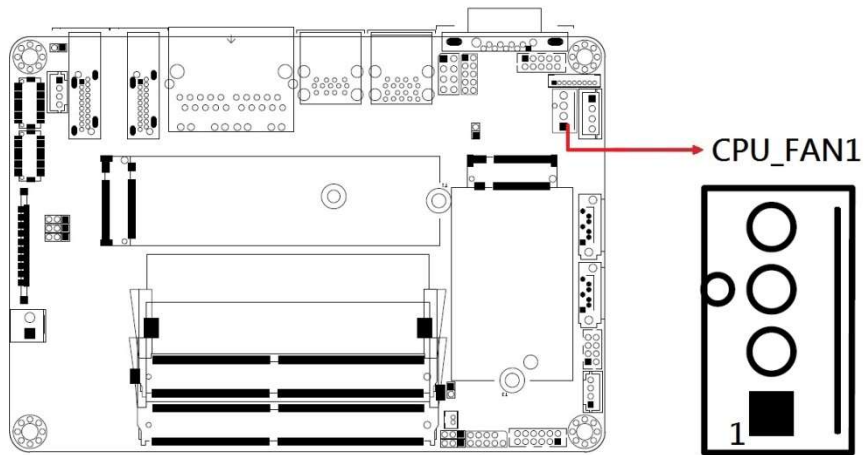

Remarks: PWM only

Pin	Assignment
1	Ground
2	+12V
3	Rotation detection
4	Control

Chapter 3

Driver Installation

The information provided in this chapter includes:

- Intel® Chipset Software Installation Utility
- Graphics Driver Installation
- HD Audio Driver Installation
- LAN Driver Installation
- Intel® Management Engine Driver Installation

3.1 Introduction

This section describes the installation procedures for software and drivers. The software and drivers are included with the motherboard. If you find anything missing, please contact the distributor where you made the purchase. The contents of this section include the following:

Note: After installing your Windows operating system, you must install the Intel® Chipset Software Installation Utility first before proceeding with the drivers installation.

3.2 Intel® Chipset Software Installation Utility

The Intel® Chipset drivers should be installed first before the software drivers to install INF files for Plug & Play function for Intel chipset components. Follow the instructions below to complete the installation.

1. Insert the drivers disk in the disk drive. Click **Intel** on the left pane and then **Intel(R) TigerLake-U Chipset Drivers** on the right pane.



2. Click **Intel(R) Chipset Software Installation Utility**.



3. When the *Welcome* screen to the Intel® Chipset Device Software appears, click **Next** to continue.
4. Accept the software license agreement and proceed with the installation process.
5. On the *Readme File Information* screen, click **Install**.
6. After completing the installation, click **Finish** to complete the setup process.

3.3 VGA Driver Installation

1. Insert the drivers disk in the disk drive. Click **Intel** on the left pane and then **Intel(R) TigerLake-U Chipset Drivers** on the right pane.



2. Click **Intel(R) HD Graphics Driver**.



3. When the *Welcome* screen appears, click **Next** to continue.
4. Click **Yes** to accept the license agreement.
5. On the *Readme File Information* screen, click **Next** until the installation starts.
6. When Setup is Complete, click **Finish** to restart the computer for changes to take effect.

3.4 HD Audio Driver Installation

1. Insert the drivers disk in the disk drive. Click **Intel** on the left pane and then **Intel(R) TigerLake-U Chipset Drivers** on the right pane.



2. Click **Realtek High Definition Audio Driver**.



3. On the *Welcome* screen of the InstallShield Wizard, click **Next**.
4. Click **Next** until the installation starts.
5. After the installation, restart the computer for changes to take effect.

3.5 LAN Driver Installation

1. Insert the drivers disk in the disk drive. Click **Intel** on the left pane and then **Intel(R) TigerLake-U Chipset Drivers** on the right pane.



2. Click **Intel(R) PRO LAN Network Drivers**.



3. On the Network Connections screen, click **Install Drivers and Software**.

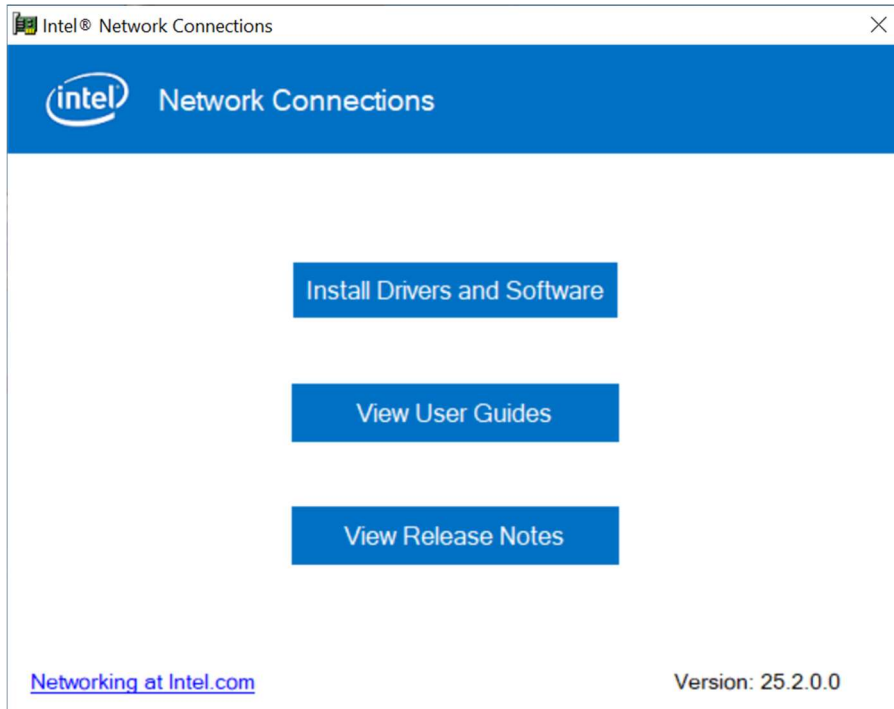

4. When the *Welcome to the install wizard for Intel(R) Network Connections* screen appears, click **Next**.

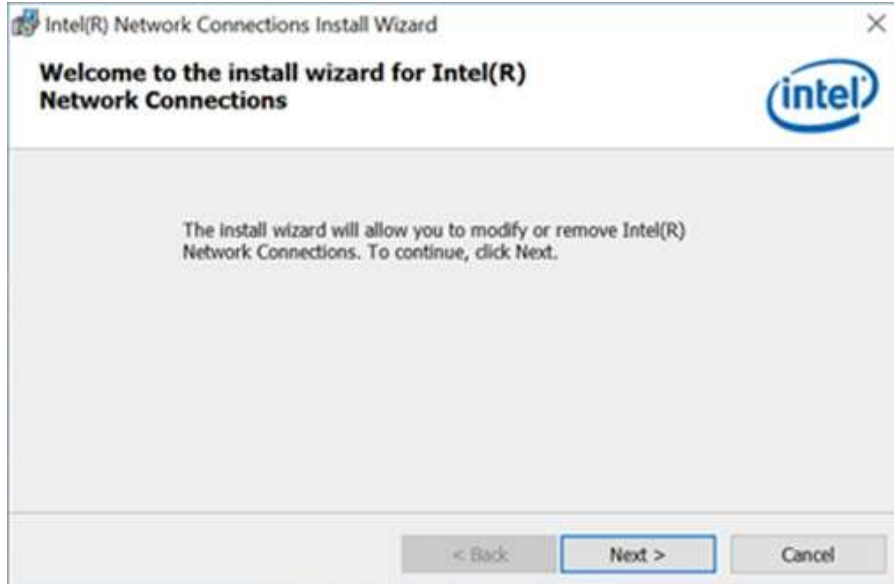

5. On the next screen, accept the license agreement and click **Next**.
6. On the *Setup Options* screen, click the checkbox to select the desired driver(s) for installation. Then click **Next** to continue.
7. On the *Ready to Install the Program* screen, click **Install** to begin the installation. When the Install wizard has completed, click **Finish**.

3.6 Intel® Management Engine Drivers Installation

1. Insert the disk enclosed in the package with the board. Click **Intel** on the left pane and then **Intel(R) TigerLake-U Chipset Drivers** on the right pane.



2. Click **Intel(R) ME 12.x Drivers**.



3. When the *Welcome* screen appears, click **Next**.
4. Accept the license agreement and click **Next**.
5. When the *Destination Folder* screen appears, click **Next** and the components will be installed.
6. After Intel Management Engine Components have been successfully installed, click **Finish**.

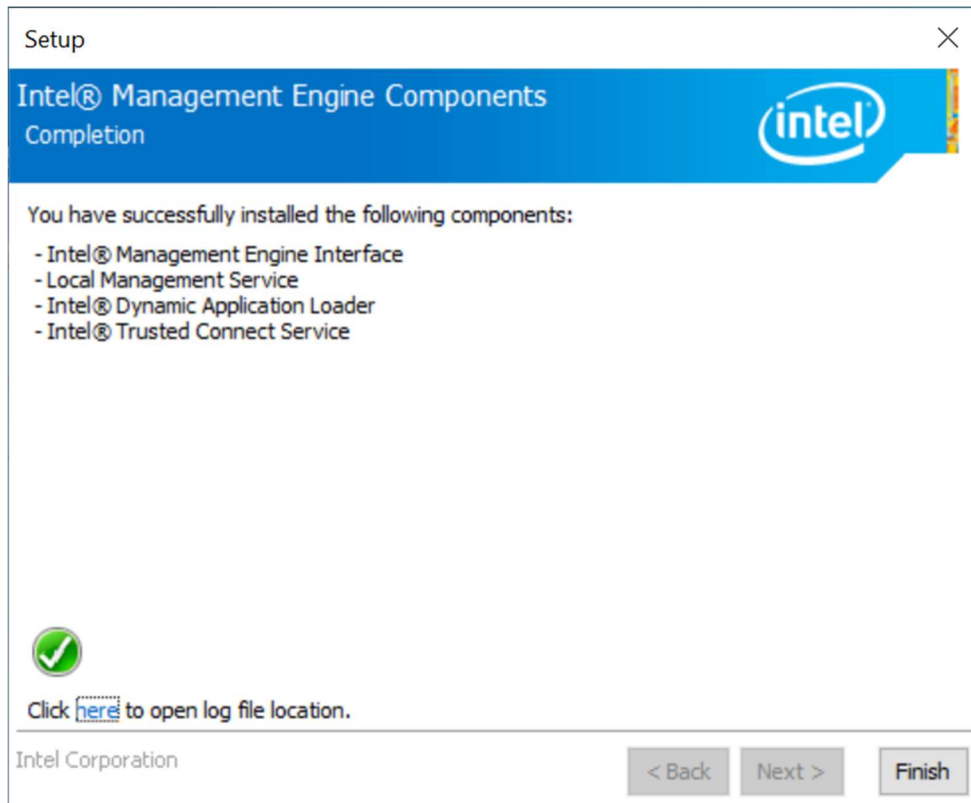

3.7 Intel® Thunderbolt Drivers Installation

1. Insert the disk enclosed in the package with the board. Click **Intel** on the left pane and then **Intel(R) TigerLake-U Chipset Drivers** on the right pane.



2. Click **Intel(R) Thunderbolt Drivers**.

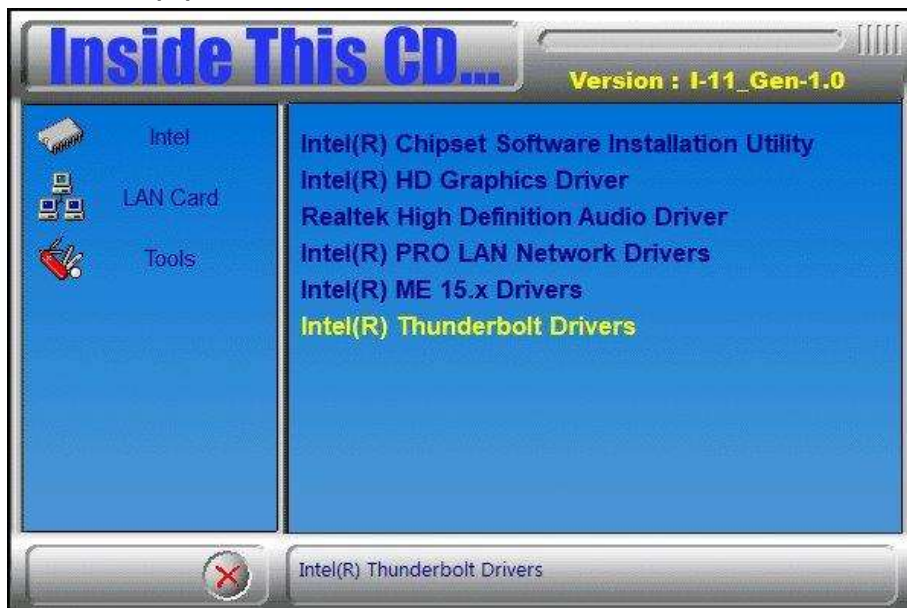

3. In the next screen, accept the license agreement and click **Next**.

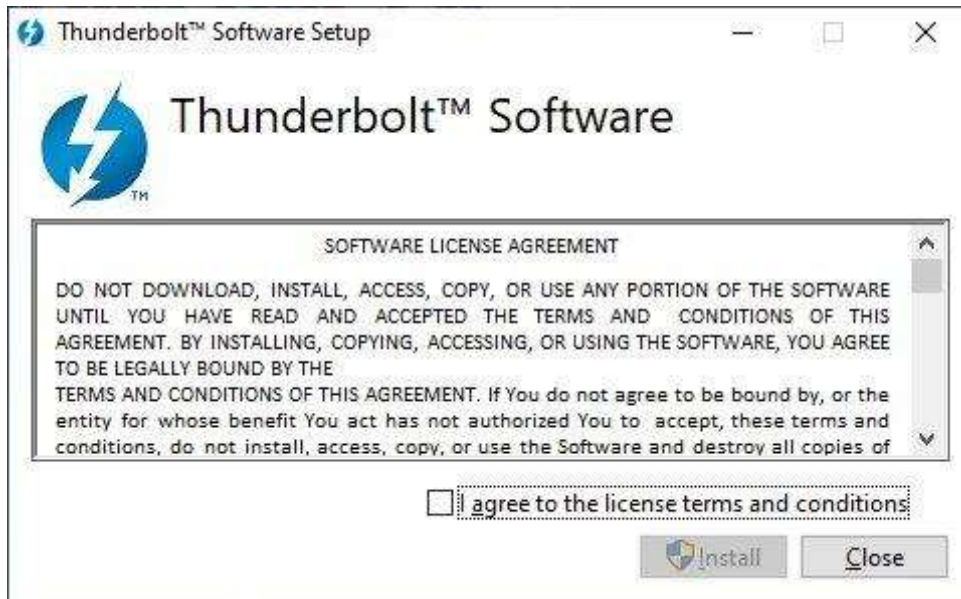

4. When the drivers have been successfully installed, click **Restart**.



Chapter 4

BIOS Setup

This chapter describes the different settings available in the AMI BIOS that comes with the board. The topics covered in this chapter are as follows:

- Main Settings
- Advanced Settings
- Chipset Settings
- Security Settings
- Boot Settings
- Save & Exit

4.1 Introduction

The BIOS (Basic Input/Output System) installed in the ROM of your computer system supports Intel® processors. The BIOS provides critical low-level support for standard devices such as disk drives, serial ports and parallel ports. It also provides password protection as well as special support for detailed fine-tuning of the chipset controlling the entire system.

4.2 BIOS Setup

The BIOS provides a Setup utility program for specifying the system configurations and settings. The BIOS ROM of the system stores the Setup utility. When you turn on the computer, the BIOS is immediately activated. Press the key immediately allows you to enter the Setup utility. If you are a little bit late pressing the key, POST (Power On Self Test) will continue with its test routines, thus preventing you from invoking the Setup.

If you still need to enter Setup, restart the system by pressing the "Reset" button or simultaneously pressing the <Ctrl>, <Alt> and <Delete> keys. You can also restart by turning the system Off and back On again.

The following message will appear on the screen:

```
Press <DEL> to Enter Setup
```

In general, press the arrow keys to highlight items, <Enter> to select, the <PgUp> and <PgDn> keys to change entries, <F1> for help, and <Esc> to quit.

When you enter the BIOS Setup utility, the *Main Menu* screen will appear on the screen. The Main Menu allows you to select from various setup functions and exit choices.

Warning: It is strongly recommended that you avoid making any changes to the chipset defaults.

These defaults have been carefully chosen by both AMI and your system manufacturer to provide the absolute maximum performance and reliability. Changing the defaults could make the system unstable and crash in some cases.

4.3 Main Settings



BIOS Setting	Description
System Date	Sets the date. Use the <Tab> key to switch between the data elements.
System Time	Set the time. Use the <Tab> key to switch between the data elements.

NOTE: Below is the corresponding screen for the IB953EF BIOS



4.4 Advanced Settings

This section allows you to configure system features according to your preference.

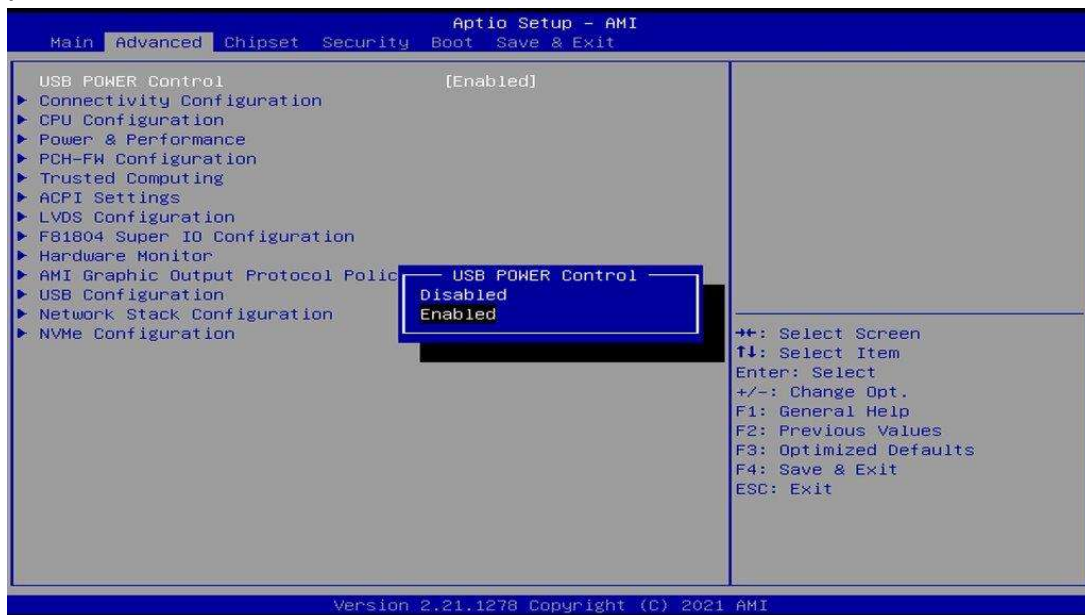

4.4.1 Connectivity Configuration



BIOS Setting	Description
CNVI Mode	This option configures Connectivity. Auto Detection – means that if Discrete solution is discovered it will be enabled by default. Otherwise Integrated solution (CNVi) will be enabled; Disable Integrated – disables Integrated Solution.
Preboot BLE	This will be used to enable Preboot Bluetooth function.
Discrete Bluetooth Module	Serial IO UART0 needs to be enabled to select BT Module. Default: Disabled
Advanced Settings	Configure ACPI objects for wireless devices Default: Disabled
WWAN Configuration	Configure WWAN related options. WWAN Device: enable or disable M.2 WWAN device
WWAN Reset Workaround	Default: Enabled

4.4.2 CPU Configuration



This section displays the type, ID and speed of the CPU.

BIOS Setting	Description
Intel (VMX) Virtualization Technology	When enabled, a VMM can utilize the additional hardware capabilities provided by Vanderpool Technology.
Active Processor Cores	Number of cores to enable in each processor package
Hyper-Threading	Options; Enabled or Disabled
AES	Enable/Disable AES (Advanced Encryption Standard)
Intel Trusted Execution Technology	Enables utilization of additional hardware capabilities provided by Intel® Trusted Execution Technology. Changes require a full power cycle to take effect.

NOTE: The selection for Hyper-Threading is available on IB953AF-i7, IB953AF-i5 and IB953EF-i3 only (not on IB953EF-CLE).

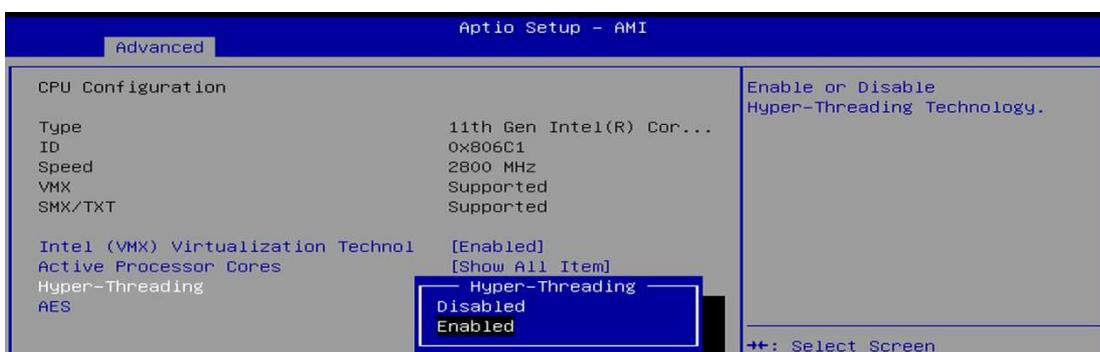

4.4.3 Power & Performance

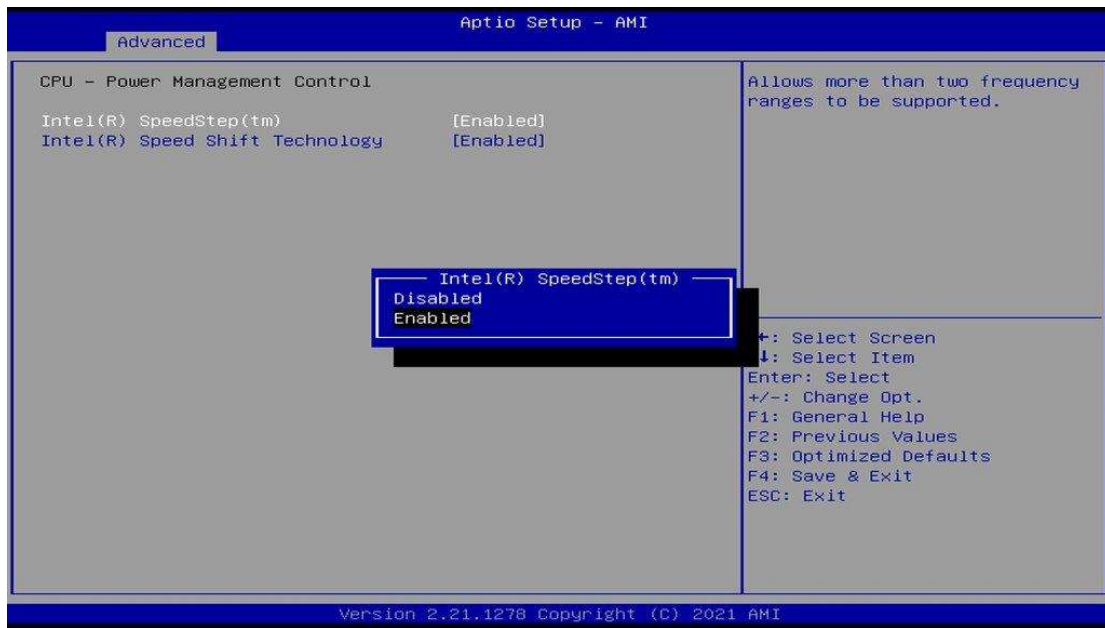

BIOS Setting	Description
Intel Speedstep	Allows more than two frequency ranges to be supported
Intel Speed Shift Technology	Enable/Disable Intel Speed Shift Technology support. Enabling will expose the CPPC v2 interface to allow for hardware controlled P-states.

4.4.4 PCH-FW Configuration

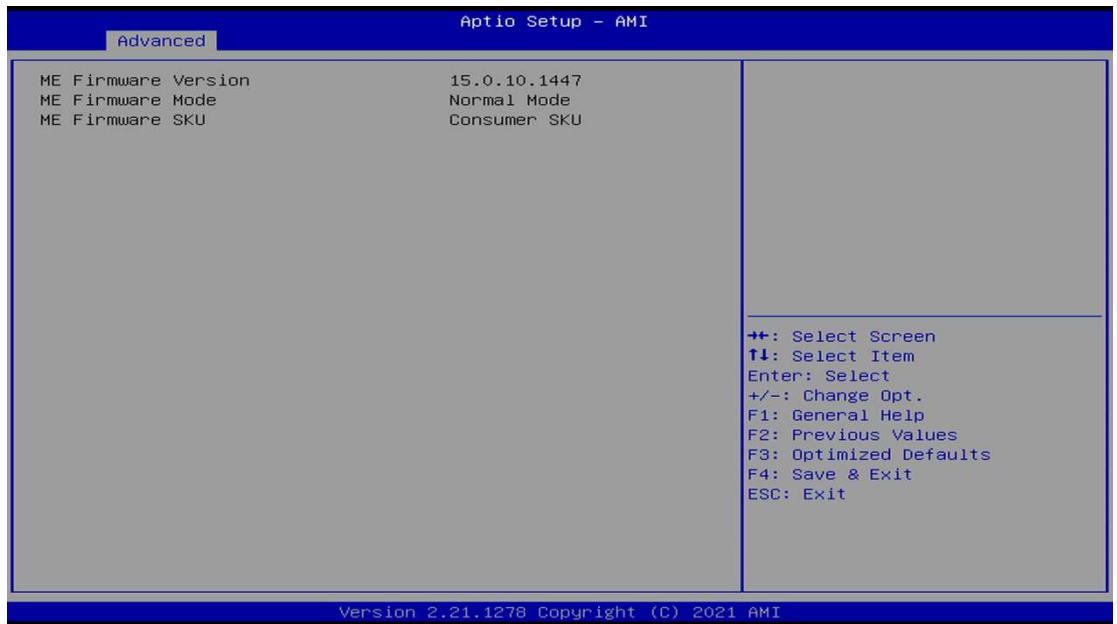
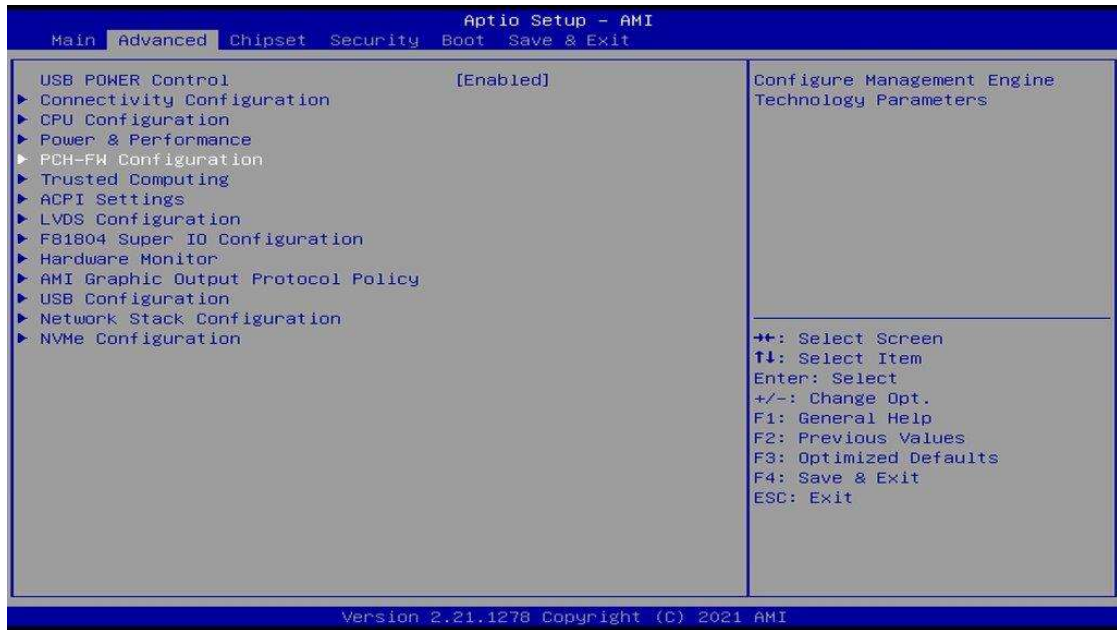

4.4.5 Trusted Computing

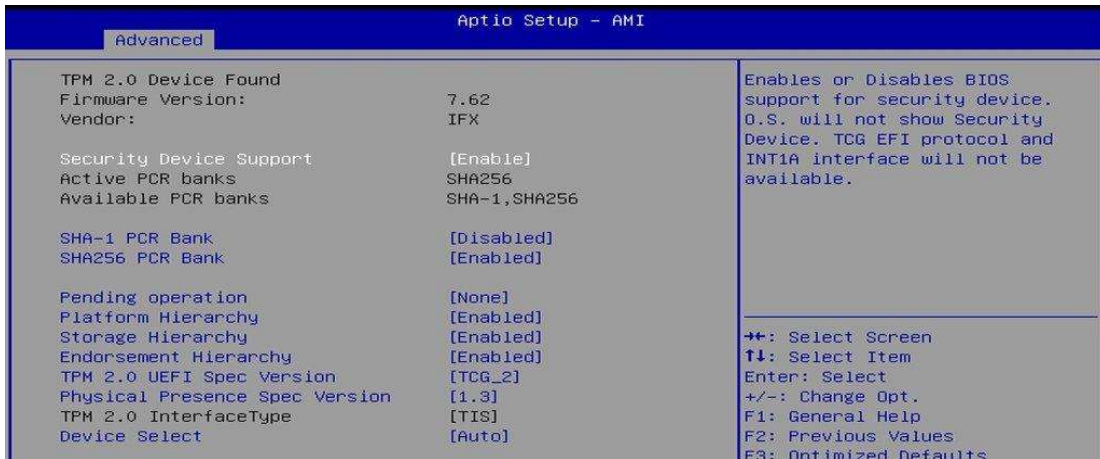

BIOS Setting	Description
Security Device Support	Enables / Disables BIOS support for security device. OS will not show security device. TCG EFI protocol and INT1A interface will not be available.
SHA-1 PCR Bank	Enables / Disables SHA-1 PCR Bank.
SHA256 PCR Bank	Enables / Disables SHA256 PCR Bank.
Pending operation	Schedule an operation for the security device. Note: Your computer will reboot during restart in order to change state of security device.
Platform Hierarchy	Enables / Disables platform hierarchy.
Storage Hierarchy	Enables / Disables storage hierarchy.
Endorsement Hierarchy	Enables / Disables endorsement hierarchy.
TPM2.0 UEFI Spec Version	Options: <ul style="list-style-type: none"> TCG_1_2: supports Win8/Win10. TCG_2: supports new TCG2 protocol and event format for Windows 10 or later.
Physical Presence Spec Version	Select to tell O.S. to support PPI Spec Version 1.2 or 1.3. Note some HCK tests might not support 1.3.
Device Select	TPM 1.2 will restrict support to TPM 1.2 devices. TPM 2.0 will restrict support to TPM 2.0 devices. Auto will support both with the default set to TPM 2.0 devices if not found, TPM 1.2 devices will be enumerated.

4.4.6 ACPI Settings

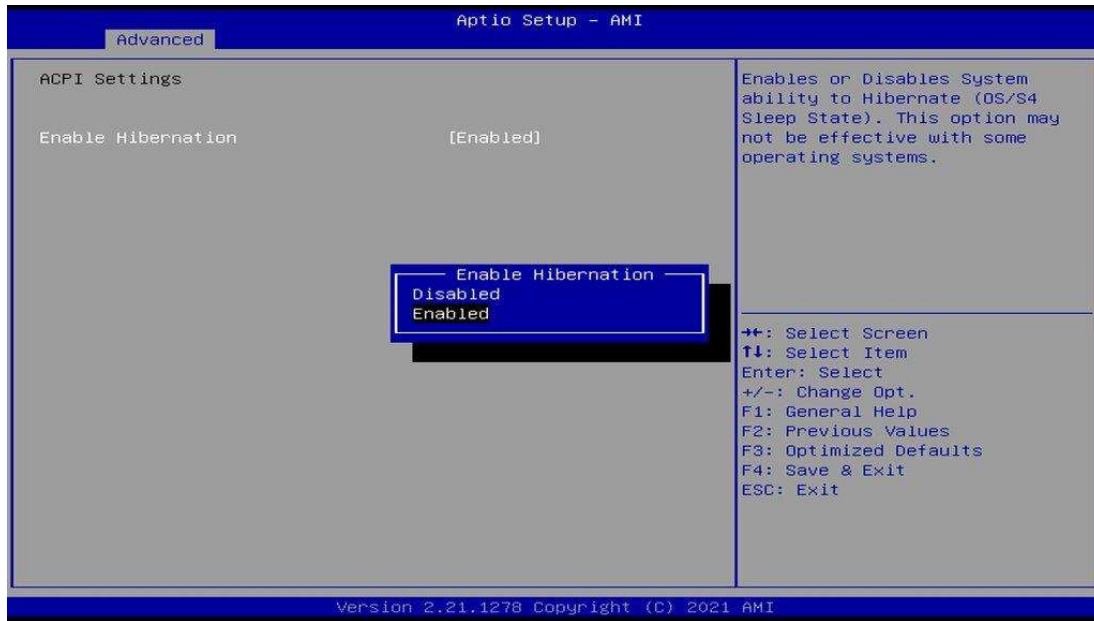

BIOS Setting	Description
Enable Hibernation	Enables / Disables the system ability to hibernate (OS/S4 Sleep State). This option may be not effective with some OS.

4.4.7 LVDS Configuration

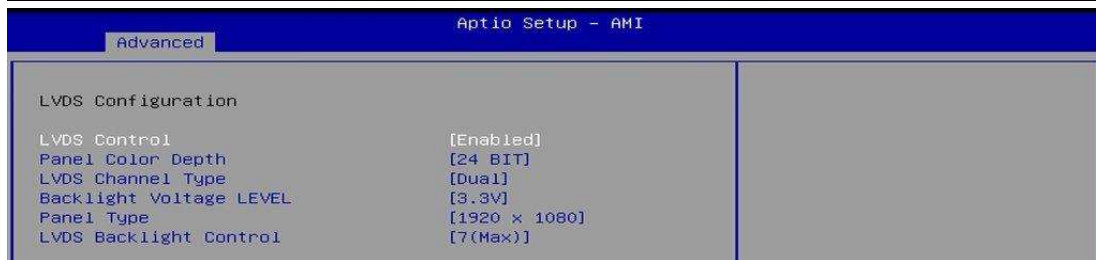
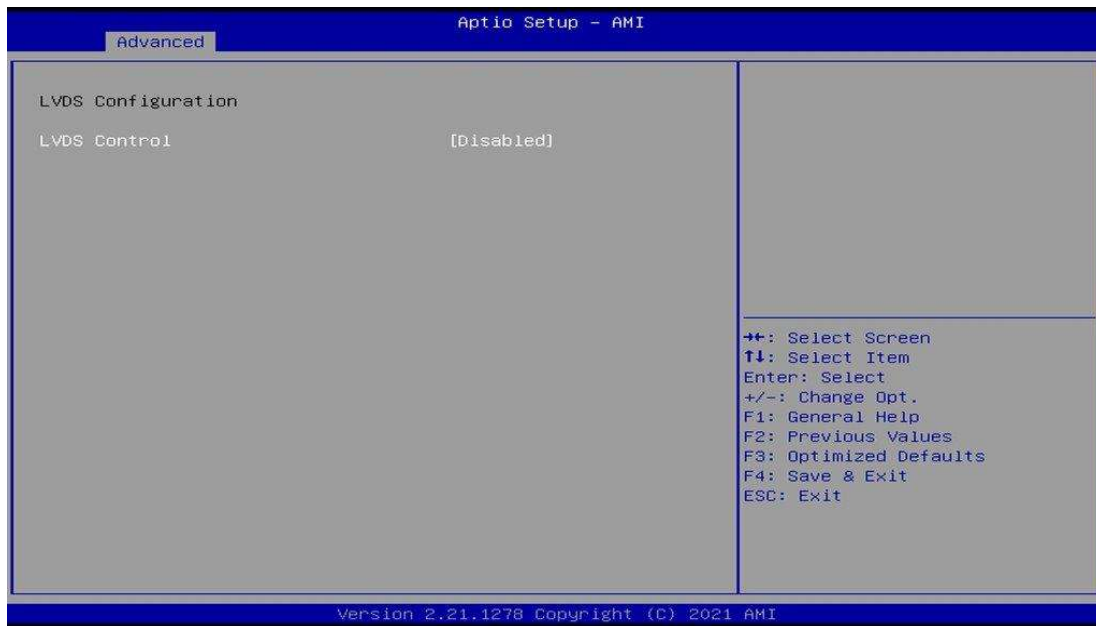

BIOS Setting	Description
LVDS Control	Default: Disabled
Panel Color Depth	Selects the panel color depth. Options: 18 bit, 24 bit
LVDS Channel Type	Chooses the LVDS as single or dual channel.
Backlight Voltage Level	Options: 3.3V, 5V
LCD Panel Type	Panel Type (Resolution) Options: 640 x 480, 800 x 600, 1024 x 768, 1280 x 768, 1280 x 800, 1280 x 960, 1280 x 1024, 1366 x 768, 1440 x 900, 1600 x 900, 1600 x 1200, 1680 x 1050, 1920 x 1080, 1920 x 1200
LVDS Brightness Control	Options: 0(Min), 1, 2, 3, 4, 5, 6, 7(Max)

4.4.8 F81804 Super IO Configuration



BIOS Setting	Description
Serial Ports Configuration	Sets parameters of serial ports. Enables / Disables the serial port and select an optimal setting for the Super IO device.
Standby Power on S5(ERP)	This feature is available in IB953EF but not in IB953AF.

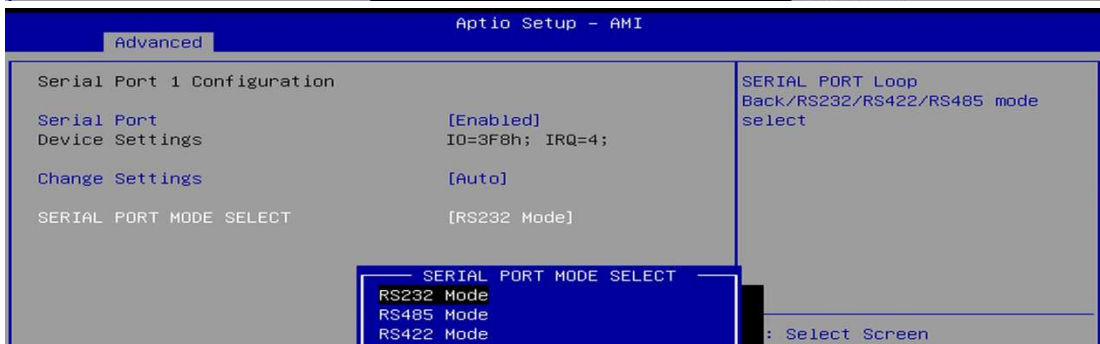
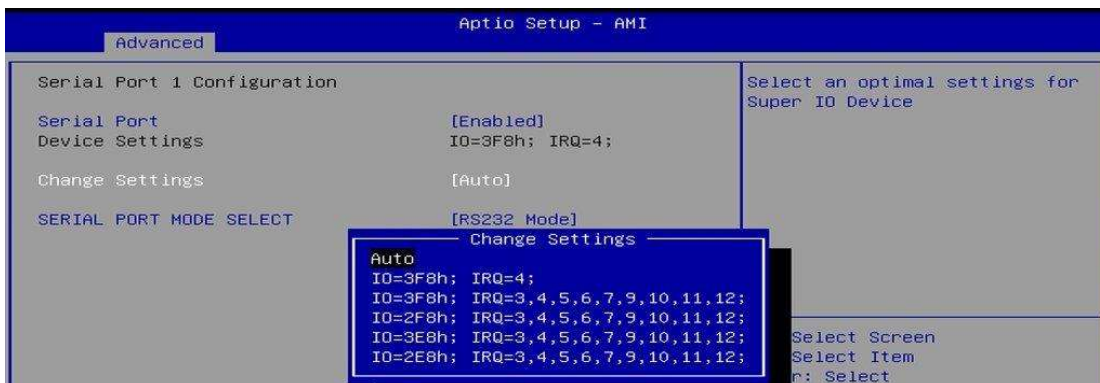

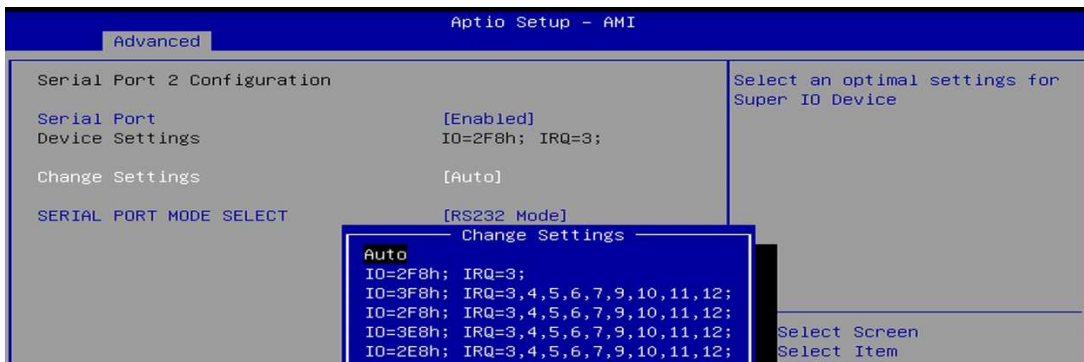
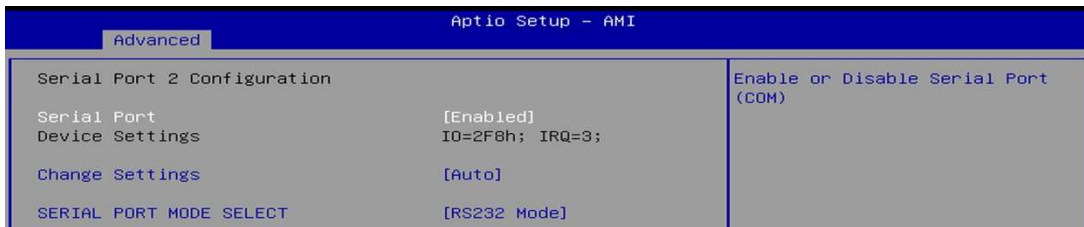
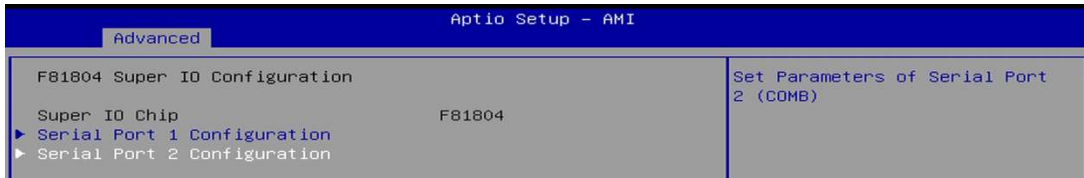

4.4.9 Hardware Monitor

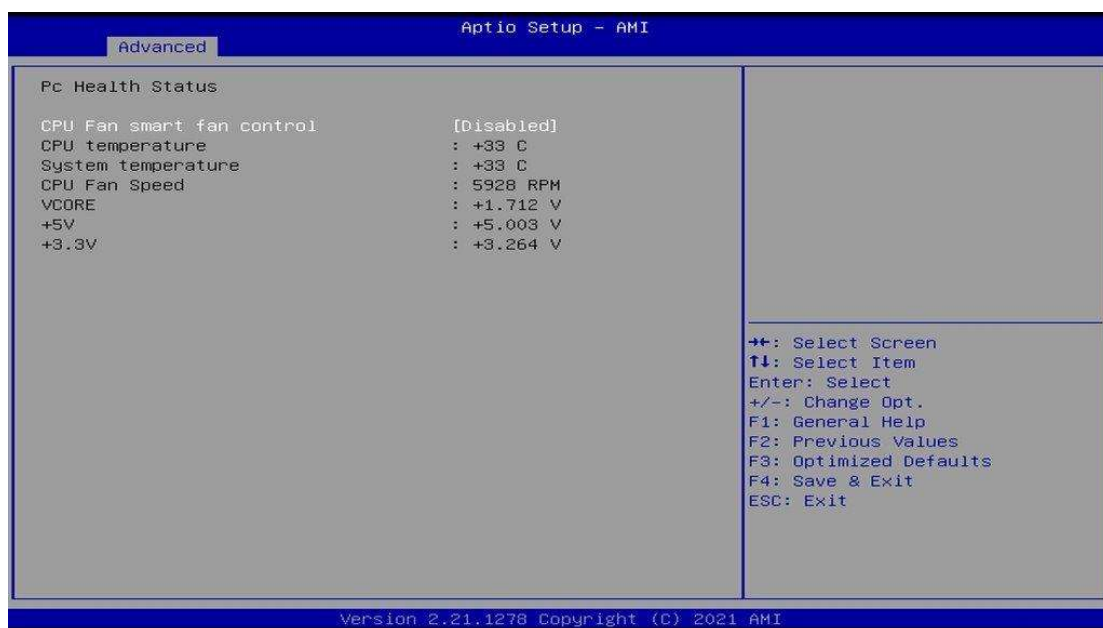

BIOS Setting	Description
CPU Fan smart fan control	Enables / Disables smart fan control.
Temperatures / Voltages	These fields are the parameters of the hardware monitoring function feature of the motherboard. The values are read-only values as monitored by the system and show the PC health status.

4.4.10 AMI Graphic Output Protocol Policy

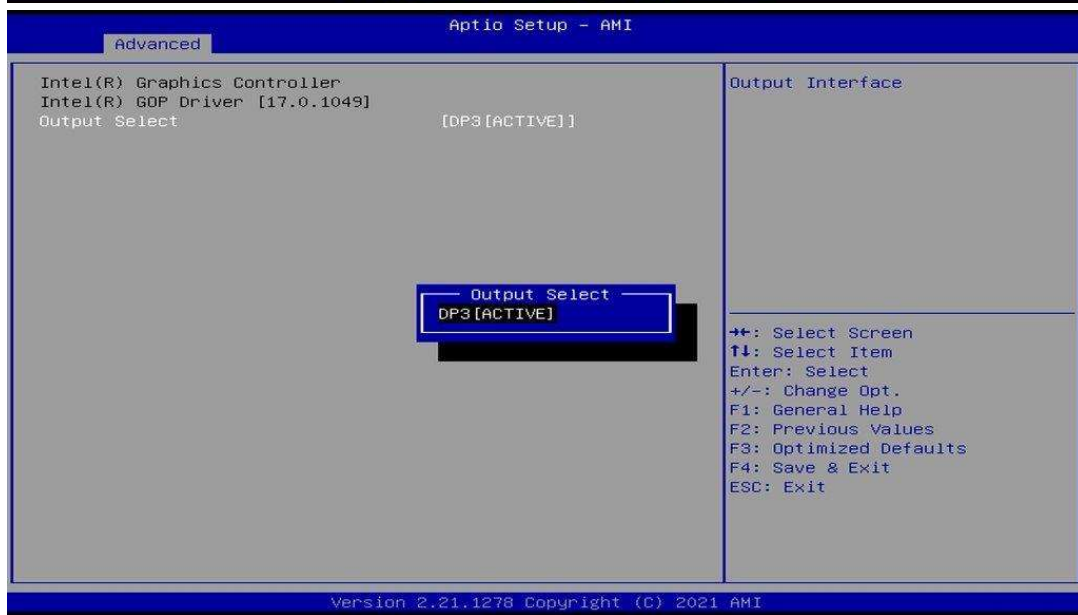

4.4.11 USB Configuration

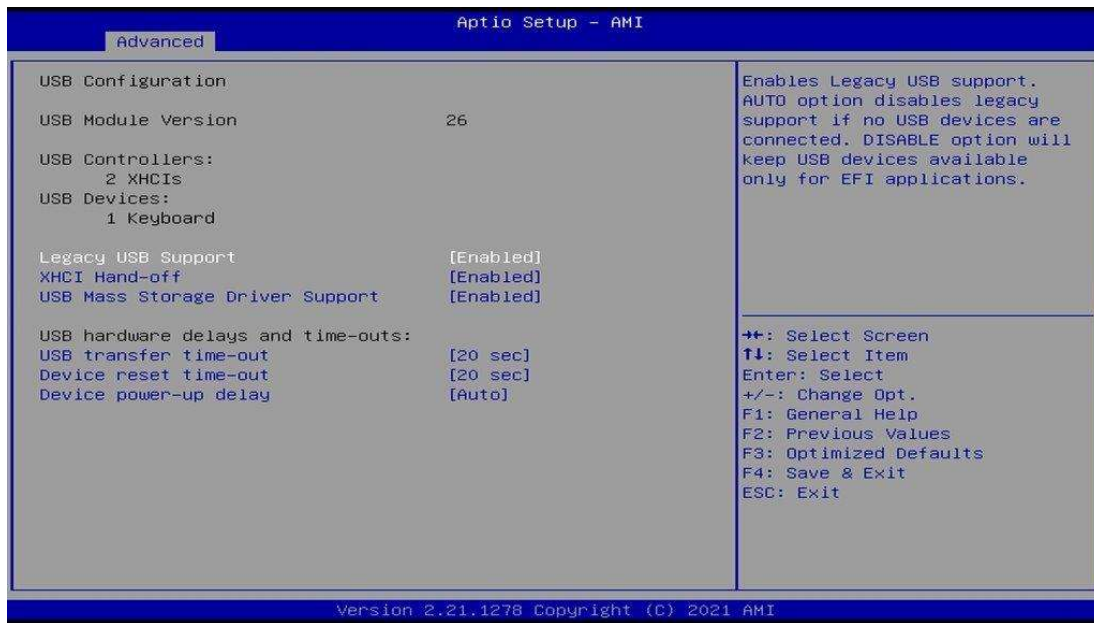

BIOS Setting	Description
Legacy USB Support	<ul style="list-style-type: none"> Enabled enables Legacy USB support. Auto disables legacy support if there is no USB device connected. Disabled keeps USB devices available only for EFI applications.
XHCI Hand-off	This is a workaround for OSES without XHCI hand-off support. The XHCI ownership change should be claimed by XHCI driver.
USB Mass Storage Driver Support	Enables / Disables the support for USB mass storage driver.
USB Transfer time-out	The time-out value (1 / 5 10 / 20 secs) for Control, Bulk, and Interrupt transfers.
Device reset time-out	Gives seconds (10 / 20 / 30 / 40 secs) to delay execution of Start Unit command to USB mass storage device.
Device power-up delay	Max.time the device will take before it properly reports itself to the Host Controller. 'Auto' uses default value: for a Root port it is 100ms, for a Hub port the delay is taken from Hub descriptor.

4.4.12 Network Stack Configuration



BIOS Setting	Description
Network Stack	Enable/Disable UEFI Network Stack
Ipv4 PXE Support	If disabled, IPv4 PXE boot support will not be available.
Ipv4 HTTP Support	If disabled, IPv4 HTTP boot support will not be available.
Ipv6 PXE Support	If disabled, IPv6 PXE boot support will not be available.
Ipv6 HTTP Support	If disabled, IPv6 HTTP boot support will not be available.
IPSEC Certificate	Support to Enable/Disable IPEC certificate.
PXE boot wait time	Wait time in seconds to press ESC key to abort the PXE boot. Use either +/- or numeric keys to set the value
Media detect count	Number of times the presence of media will be checked. Use either +/- nurmeric keys to set the value.

4.4.13 NVMe Configuration

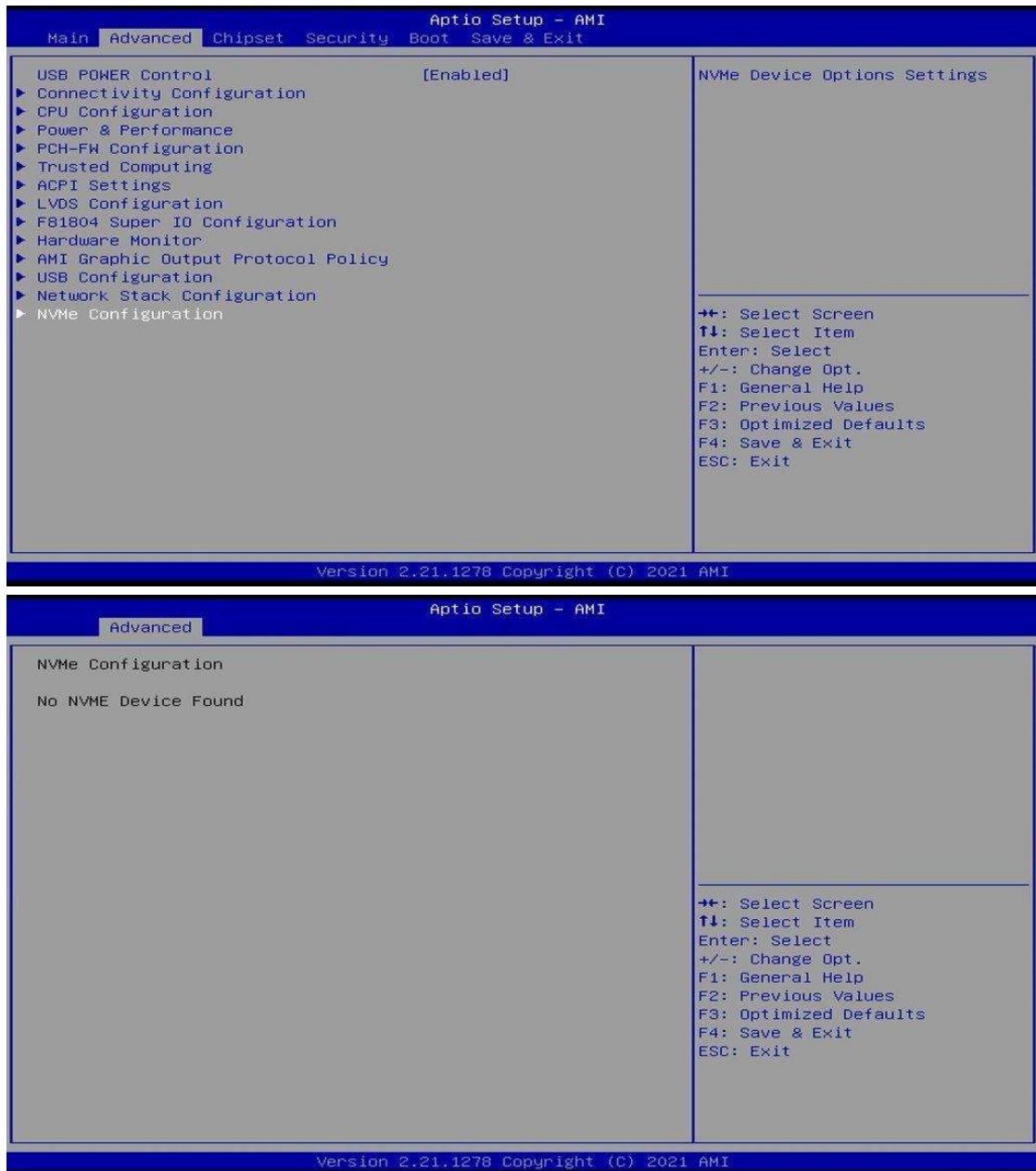

4.5 Chipset Settings

4.5.1 System Agent (SA) Configuration



4.5.1.1. Graphics Configuration:

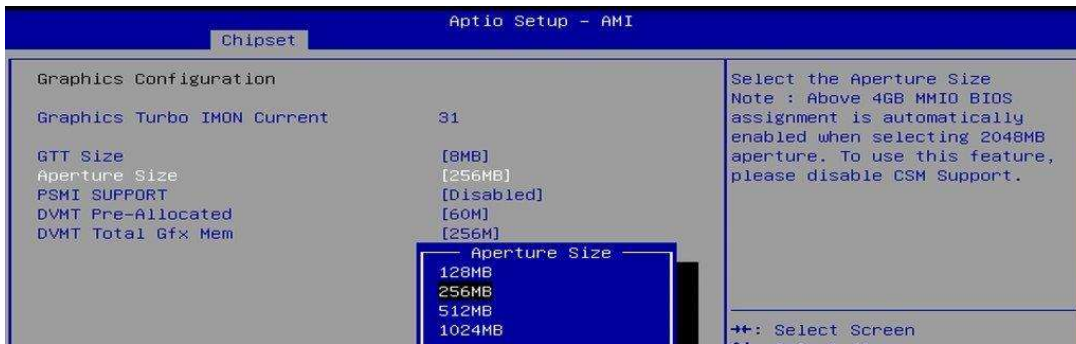
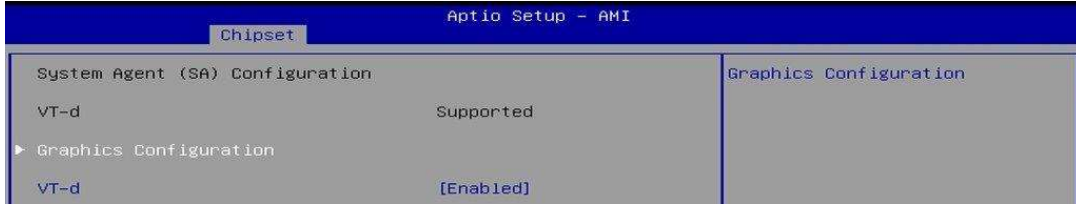

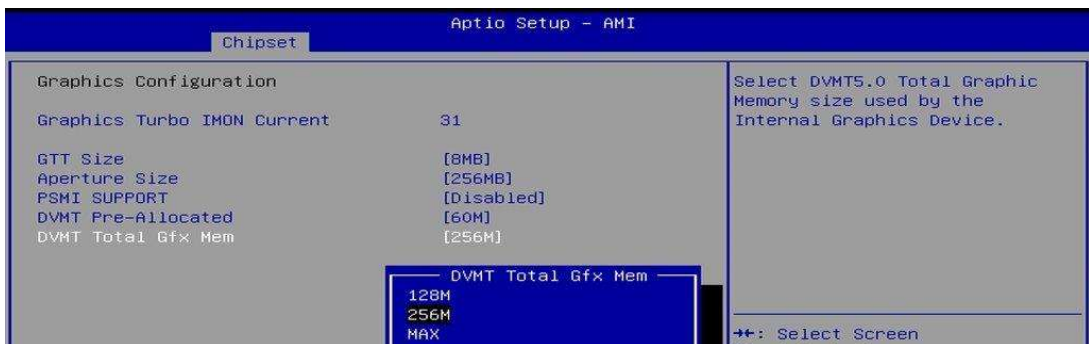
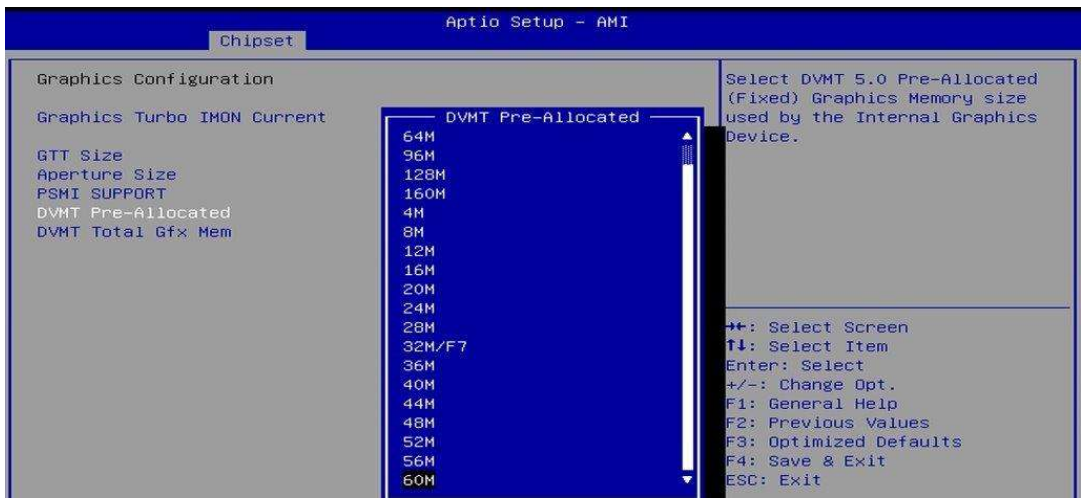

4.5.1.2. VT-d

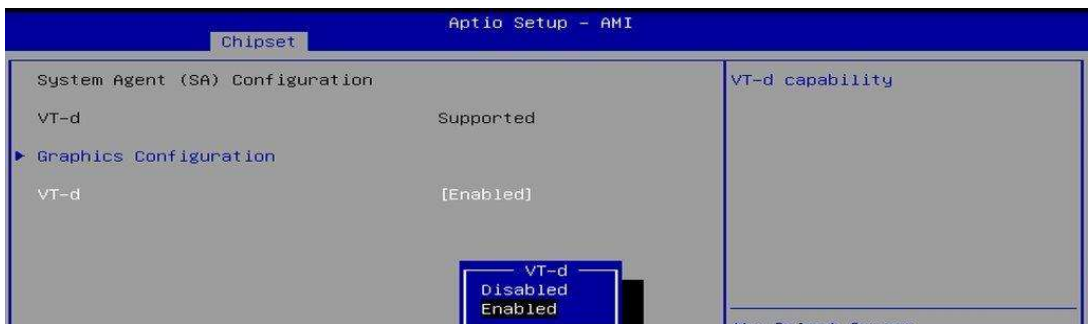

4.5.2 PCH-IO Configuration

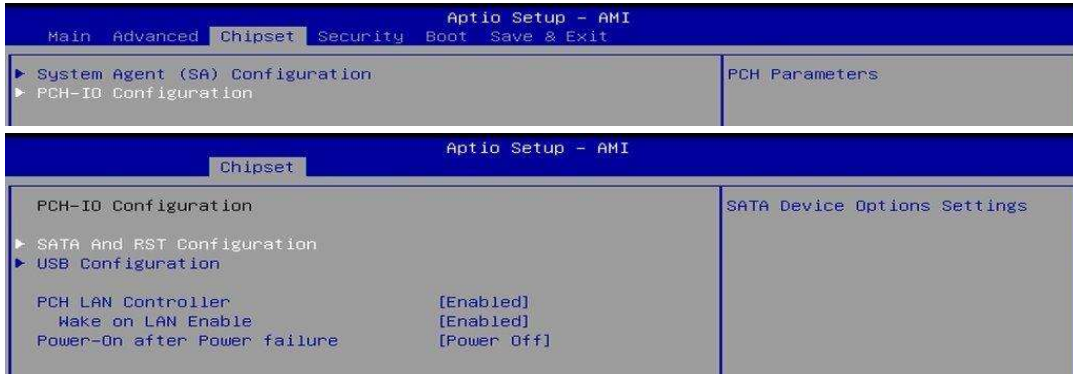

4.5.2.1 SATA and RST Configuration:

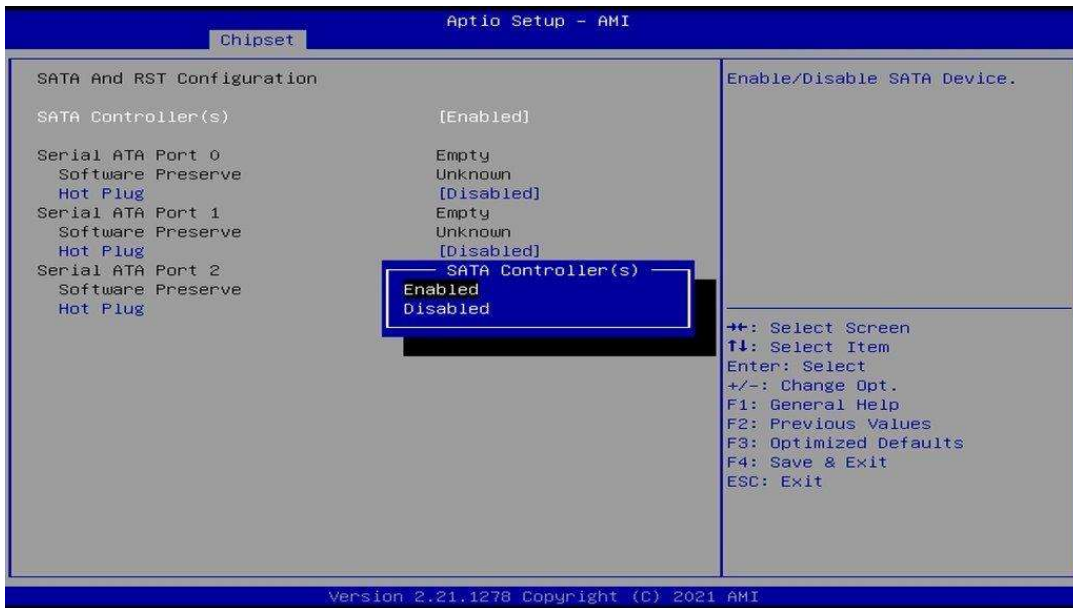

BIOS Setting	Description
SATA and RST Configuration	SATA device options and settings
SATA Controller(s)	Enables / Disables the Serial ATA.
SATA Mode Selection	Selects IDE or AHCI Mode.
Serial ATA Port 0~2	Enables / Disables Serial Port 0 ~ 2.
SATA Ports Hot Plug	Enables / Disables SATA Ports HotPlug.

4.5.2.2 SATA and RST Configuration:

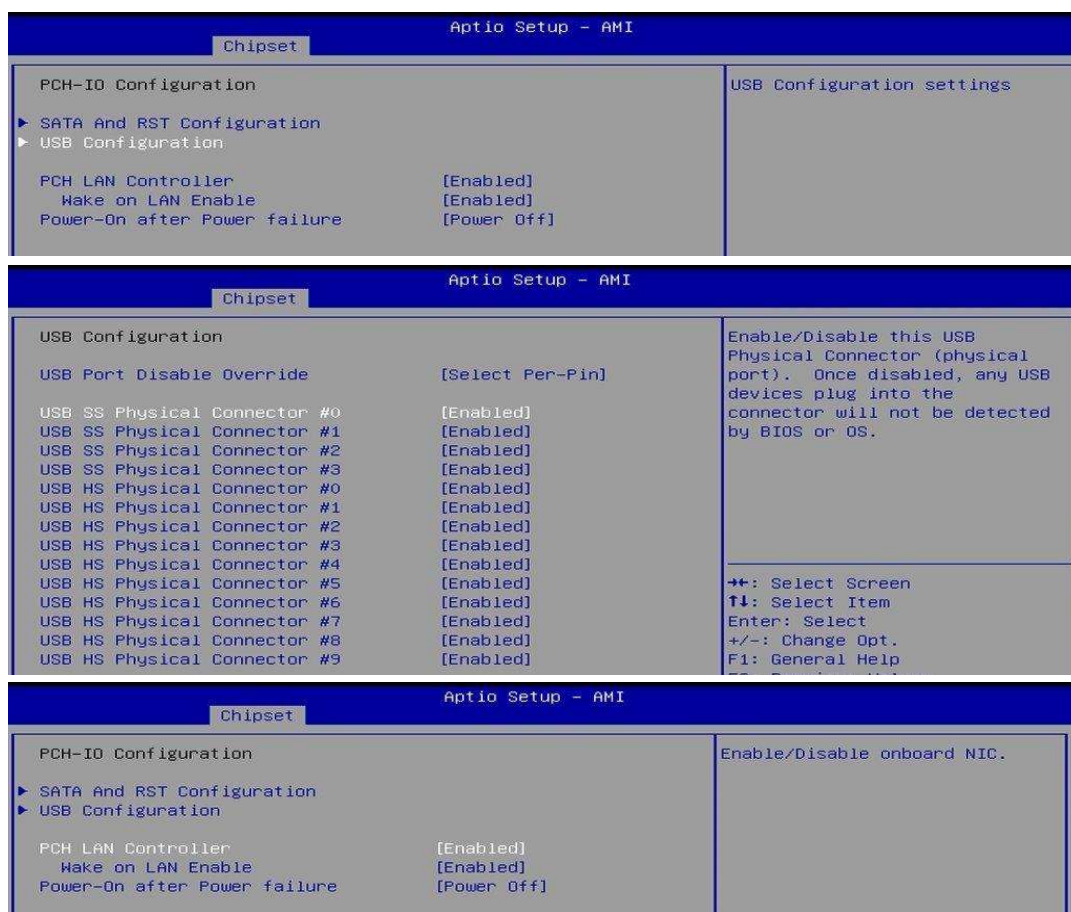

BIOS Setting	Description
USB Port Disable Overwrite	Selectively Enable/Disable the corresponding USB port from reporting a Device Connection to the controller. Options: Disabled, Select Per-Pin
USB SS Physical Connector	Enable/Disable the USB Physical Connector (physical port). Once disabled, any USB devices plug into the connector will not be detected by BIOS or OS.
PCH LAN Controller	Enables / Disables onboard NIC.
Wake on LAN Enable	Enables / Disables integrated LAN to wake the system.
Power-On after Power failure	Specify what state to to when power is re-applied after a power failure (G3 state)

4.6 Security Settings



BIOS Setting	Description
Setup Administrator Password	Sets an administrator password for the setup utility.
User Password	Sets a user password.
Secure Boot	Secure Boot feature is Active if Secure Boot is enabled. Platform Key(PK) is enrolled and the system is in user mode. The mode change requires platform reset.
Secure Boot Mode	Secure Boot mode options: Standard or Custom. In Custom mode, Secure Boot Policy variables can be configured by a physically present user without full authentication

4.7 Boot Settings

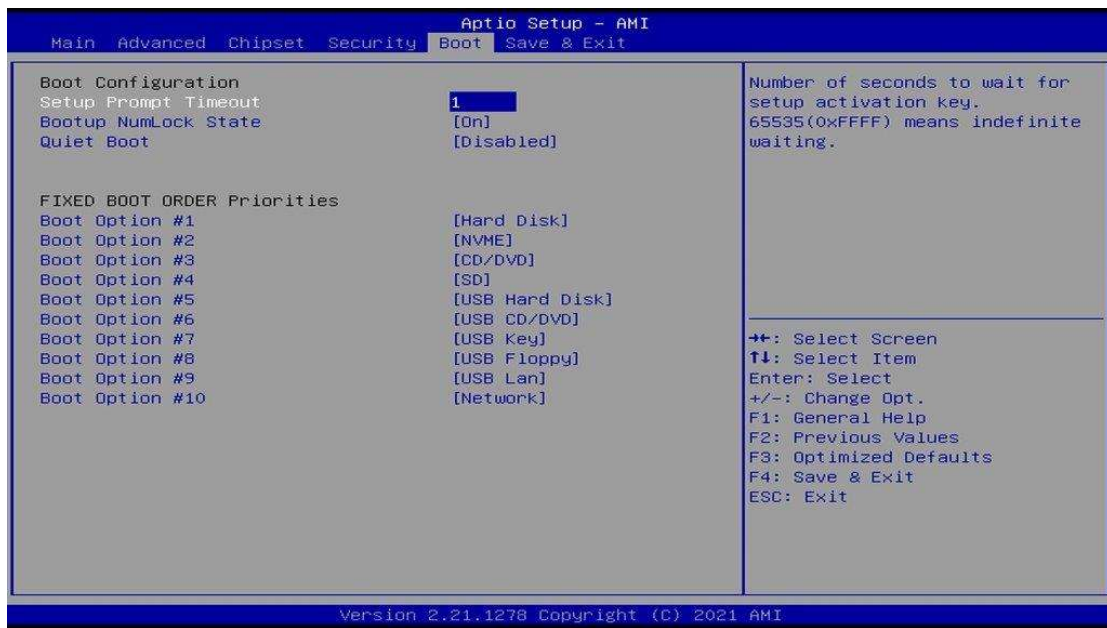

BIOS Setting	Description
Setup Prompt Timeout	Number of seconds to wait for setup activation key. 65535 (0xFFFF) means indefinite waiting.
Bootup NumLock State	Selects the keyboard NumLock state.
Quiet Boot	Enables / Disables Quiet Boot option.
FIXED BOOT ORDER Priorities	Sets the system boot order.



4.8 Save & Exit Settings



BIOS Setting	Description
Save Changes and Exit	Exits system setup after saving the changes.
Discard Changes and Exit	Exits system setup without saving any changes.
Save Changes and Reset	Resets the system after saving the changes.
Discard Changes and Reset	Resets system setup without saving any changes.
Save Changes	Saves changes done so far to any of the setup options.
Discard Changes	Discards changes done so far to any of the setup options.
Restore Defaults	Restores / Loads defaults values for all the setup options.
Save as User Defaults	Saves the changes done so far as User Defaults.
Restore User Defaults	Restores the user defaults to all the setup options.
Launch EFI Shell from filesystem device	Attempts to launch EFI shell application (Shell.efi) from one of the available filesystem devices.

Appendix

This section provides the mapping addresses of peripheral devices and the sample code of watchdog timer configuration.

A. I/O Port Address Map

Each peripheral device in the system is assigned a set of I/O port addresses which also becomes the identity of the device. The following table lists the I/O port addresses used.

Address	Device Description
0x00000A00-0x00000A0F	Motherboard resources
0x00000A20-0x00000A2F	Motherboard resources
0x00000A10-0x00000A1F	Motherboard resources
0x0000002E-0x0000002F	Motherboard resources
0x0000004E-0x0000004F	Motherboard resources
0x00000061-0x00000061	Motherboard resources
0x00000063-0x00000063	Motherboard resources
0x00000065-0x00000065	Motherboard resources
0x00000067-0x00000067	Motherboard resources
0x00000070-0x00000070	Motherboard resources
0x00000080-0x00000080	Motherboard resources
0x00000092-0x00000092	Motherboard resources
0x000000B2-0x000000B3	Motherboard resources
0x00000680-0x0000069F	Motherboard resources
0x0000164E-0x0000164F	Motherboard resources
0x00000020-0x00000021	Programmable interrupt controller
0x00000024-0x00000025	Programmable interrupt controller
0x00000028-0x00000029	Programmable interrupt controller
0x0000002C-0x0000002D	Programmable interrupt controller
0x00000030-0x00000031	Programmable interrupt controller
0x00000034-0x00000035	Programmable interrupt controller
0x00000038-0x00000039	Programmable interrupt controller
0x0000003C-0x0000003D	Programmable interrupt controller
0x000000A0-0x000000A1	Programmable interrupt controller
0x000000A4-0x000000A5	Programmable interrupt controller
0x000000A8-0x000000A9	Programmable interrupt controller
0x000000AC-0x000000AD	Programmable interrupt controller
0x000000B0-0x000000B1	Programmable interrupt controller
0x000000B4-0x000000B5	Programmable interrupt controller
0x000000B8-0x000000B9	Programmable interrupt controller
0x000000BC-0x000000BD	Programmable interrupt controller
0x000004D0-0x000004D1	Programmable interrupt controller

Address	Device Description
0x00001854-0x00001857	Motherboard resources
0x00004090-0x00004097	Standard SATA AHCI Controller
0x00004080-0x00004083	Standard SATA AHCI Controller
0x00004060-0x0000407F	Standard SATA AHCI Controller
0x000003F8-0x000003FF	Communications Port (COM1)
0x000002F8-0x000002FF	Communications Port (COM2)
0x00001800-0x000018FE	Motherboard resources
0x00004000-0x0000403F	Intel(R) UHD Graphics
0x00000000-0x00000CF7	PCI Express Root Complex
0x00000D00-0x0000FFFF	PCI Express Root Complex
0x00000040-0x00000043	System timer
0x00000050-0x00000053	System timer
0x00003000-0x00003FFF	Intel(R) PCI Express Root Port #7 - A0BE
0x00002000-0x000020FE	Motherboard resources
0x00000060-0x00000060	Standard PS/2 Keyboard
0x00000064-0x00000064	Standard PS/2 Keyboard
0x0000EFA0-0x0000EFBF	Intel(R) SMBus - A0A3

B. Interrupt Request Lines (IRQ)

Peripheral devices use interrupt request lines to notify CPU for the service required. The following table shows the IRQ used by the devices on board.

Level	Function
IRQ 4294967288	Intel(R) Ethernet Connection (13) I219-V
IRQ 4294967289	Intel(R) USB 3.10 eXtensible Host Controller - 1.20 (Microsoft)
IRQ 4294967291	Standard SATA AHCI Controller
IRQ 4294967290	Intel(R) USB 3.10 eXtensible Host Controller - 1.20 (Microsoft)
IRQ 4	Communications Port (COM1)
IRQ 3	Communications Port (COM2)
IRQ 4294967284	Intel(R) UHD Graphics
IRQ 54 ~ IRQ 204	Microsoft ACPI-Compliant System
IRQ 256 ~ IRQ 511	Microsoft ACPI-Compliant System
IRQ 4294967294	PCI Express Root Port
IRQ 14	Intel(R) GPIO Controller - 34C5
IRQ 0	System timer
IRQ 28	Trusted Platform Module 2.0
IRQ 4294967292	Intel(R) PCI Express Root Port #7 - A0BE
IRQ 4294967282	Intel(R) Management Engine Interface
IRQ 1	Standard PS/2 Keyboard
IRQ 12	Microsoft PS/2 Mouse
IRQ 4294967287	Intel(R) I211 Gigabit Network Connection
IRQ 4294967286	Intel(R) I211 Gigabit Network Connection
IRQ 4294967285	Intel(R) I211 Gigabit Network Connection
IRQ 4294967283	Intel(R) I211 Gigabit Network Connection
IRQ 4294967293	PCI Express Root Port
IRQ 16	High Definition Audio Controller
IRQ 17	USB Synopsys Controller

C. Watchdog Timer Configuration

The Watchdog Timer (WDT) is used to generate a variety of output signals after a user programmable count. The WDT is suitable for use in the prevention of system lock-up, such as when software becomes trapped in a deadlock. Under these sorts of circumstances, the timer will count to zero and the selected outputs will be driven.

Under normal circumstance, you will need to restart the WDT at regular intervals before the timer counts to zero.

Sample Code:

```
//-----
//
// THIS CODE AND INFORMATION IS PROVIDED "AS IS" WITHOUT WARRANTY OF ANY
// KIND, EITHER EXPRESSED OR IMPLIED, INCLUDING BUT NOT LIMITED TO THE
// IMPLIED WARRANTIES OF MERCHANTABILITY AND/OR FITNESS FOR A
// PARTICULAR
// PURPOSE.
//
//-----
#include <dos.h>
#include <conio.h>
#include <stdio.h>
#include <stdlib.h>
#include " F81804.H"
//-----
int main (int argc, char *argv[]);
void EnableWDT(int);
void DisableWDT(void);
//-----
int main (int argc, char *argv[])
{
    unsigned char bBuf;
    unsigned char bTime;
    char **endptr;

    char SIO;

    printf("Fintek 81866 watch dog program\n");
    SIO = Init_ F81804();
    if (SIO == 0)
    {
        printf("Can not detect Fintek 81866, program abort.\n");
        return(1);
    }//if (SIO == 0)

    if (argc != 2)
    {
        printf(" Parameter incorrect!!\n");
        return (1);
    }
}
```

```

    }

    bTime = strtol(argv[1], endptr, 10);
    printf("System will reset after %d seconds\n", bTime);

    if (bTime)
    { EnableWDT(bTime); }
    else
    { DisableWDT(); }
    return 0;
}
//-----
void EnableWDT(int interval)
{
    unsigned char bBuf;

    bBuf = Get_F81804_Reg(0x2B);
    bBuf &= (~0x20);
    Set_F81804_Reg(0x2B, bBuf); //Enable WDTO

    Set_F81804_LD(0x07);          //switch to logic device 7
    Set_F81804_Reg(0x30, 0x01); //enable timer

    bBuf = Get_F81804_Reg(0xF5);
    bBuf &= (~0x0F);
    bBuf |= 0x52;
    Set_F81804_Reg(0xF5, bBuf); //count mode is second

    Set_F81804_Reg(0xF6, interval); //set timer

    bBuf = Get_F81804_Reg(0xFA);
    bBuf |= 0x01;
    Set_F81804_Reg(0xFA, bBuf); //enable WDTO output

    bBuf = Get_F81804_Reg(0xF5);
    bBuf |= 0x20;
    Set_F81804_Reg(0xF5, bBuf); //start counting
}
//-----
void DisableWDT(void)
{
    unsigned char bBuf;

    Set_F81804_LD(0x07);          //switch to logic device 7

    bBuf = Get_F81804_Reg(0xFA);
    bBuf &= ~0x01;
    Set_F81804_Reg(0xFA, bBuf); //disable WDTO output

    bBuf = Get_F81804_Reg(0xF5);
    bBuf &= ~0x20;
    bBuf |= 0x40;
    Set_F81804_Reg(0xF5, bBuf); //disable WDT
}

```

```

//-----

//-----
//
// THIS CODE AND INFORMATION IS PROVIDED "AS IS" WITHOUT WARRANTY OF ANY
// KIND, EITHER EXPRESSED OR IMPLIED, INCLUDING BUT NOT LIMITED TO THE
// IMPLIED WARRANTIES OF MERCHANTABILITY AND/OR FITNESS FOR A
// PARTICULAR
// PURPOSE.
//
//-----
#include " F81804.H"
#include <dos.h>
//-----
unsigned int  F81804_BASE;
void Unlock_ F81804 (void);
void Lock_ F81804 (void);
//-----
unsigned int Init_ F81804(void)
{
    unsigned int result;
    unsigned char ucDid;

    F81804_BASE = 0x4E;
    result = F81804_BASE;

    ucDid = Get_ F81804_Reg(0x20);
    if (ucDid == 0x07) //Fintek 81866
    { goto Init_Finish; }

    F81804_BASE = 0x2E;
    result = F81804_BASE;

    ucDid = Get_ F81804_Reg(0x20);
    if (ucDid == 0x07) //Fintek 81866
    { goto Init_Finish; }

    F81804_BASE = 0x00;
    result = F81804_BASE;

Init_Finish:
    return (result);
}
//-----
void Unlock_ F81804 (void)
{
    outportb( F81804_INDEX_PORT, F81804_UNLOCK);
    outportb( F81804_INDEX_PORT, F81804_UNLOCK);
}
//-----
void Lock_ F81804 (void)
{
    outportb( F81804_INDEX_PORT, F81804_LOCK);
}

```

```
}  
//-----  
void Set_F81804_LD( unsigned char LD)  
{  
    Unlock_F81804();  
    outportb( F81804_INDEX_PORT, F81804_REG_LD);  
    outportb( F81804_DATA_PORT, LD);  
    Lock_F81804();  
}  
//-----  
void Set_F81804_Reg( unsigned char REG, unsigned char DATA)  
{  
    Unlock_F81804();  
    outportb( F81804_INDEX_PORT, REG);  
    outportb( F81804_DATA_PORT, DATA);  
    Lock_F81804();  
}  
//-----  
unsigned char Get_F81804_Reg(unsigned char REG)  
{  
    unsigned char Result;  
    Unlock_F81804();  
    outportb( F81804_INDEX_PORT, REG);  
    Result = inportb( F81804_DATA_PORT);  
    Lock_F81804();  
    return Result;  
}  
//-----
```

```
//-----  
//  
// THIS CODE AND INFORMATION IS PROVIDED "AS IS" WITHOUT WARRANTY OF ANY  
// KIND, EITHER EXPRESSED OR IMPLIED, INCLUDING BUT NOT LIMITED TO THE  
// IMPLIED WARRANTIES OF MERCHANTABILITY AND/OR FITNESS FOR A  
// PARTICULAR  
// PURPOSE.  
//  
//-----  
#ifndef    F81804_H  
#define    F81804_H        1  
//-----  
#define    F81804_INDEX_PORT    ( F81804_BASE)  
#define    F81804_DATA_PORT    ( F81804_BASE+1)  
//-----  
#define    F81804_REG_LD    0x07  
//-----  
#define    F81804_UNLOCK    0x87  
#define    F81804_LOCK0xAA  
//-----  
unsigned int Init_ F81804(void);  
void Set_ F81804_LD( unsigned char);  
void Set_ F81804_Reg( unsigned char,  
unsigned char); unsigned char  
Get_ F81804_Reg( unsigned char);  
//-----  
#endif //    F81804_H
```

Our company network supports you worldwide with offices in Germany, Austria, Switzerland, the UK and the USA. For more information please contact:

Headquarters

Germany



FORTEC Elektronik AG

Augsburger Str. 2b
82110 Germering

Phone: +49 89 894450-0
E-Mail: info@fortecaq.de
Internet: www.fortecaq.de

Fortec Group Members

Austria



Distec GmbH Office Vienna

Nuschinggasse 12
1230 Wien

Phone: +43 1 8673492-0
E-Mail: info@distec.de
Internet: www.distec.de

Germany



Distec GmbH

Augsburger Str. 2b
82110 Germering

Phone: +49 89 894363-0
E-Mail: info@distec.de
Internet: www.distec.de

Switzerland



ALTRAC AG

Bahnhofstraße 3
5436 Würenlos

Phone: +41 44 7446111
E-Mail: info@altrac.ch
Internet: www.altrac.ch

United Kingdom



Display Technology Ltd.

Osprey House, 1 Osprey Court
Hinchingsbrooke Business Park
Huntingdon, Cambridgeshire, PE29 6FN

Phone: +44 1480 411600
E-Mail: info@displaytechnology.co.uk
Internet: www.displaytechnology.co.uk

USA



Apollo Display Technologies, Corp.

87 Raynor Avenue, Unit 1
Ronkonkoma, NY 11779

Phone: +1 631 5804360
E-Mail: info@apolloDisplays.com
Internet: www.apolloDisplays.com