



OUR GLOBAL
COMPETENCE
CENTRES

 APOLLO DISPLAY
TECHNOLOGIES



 DISTEC



 DISPLAY
TECHNOLOGY



Manual

congatec

conga-SEVAL

Evaluation Carrier Board compatible with SMARC modules

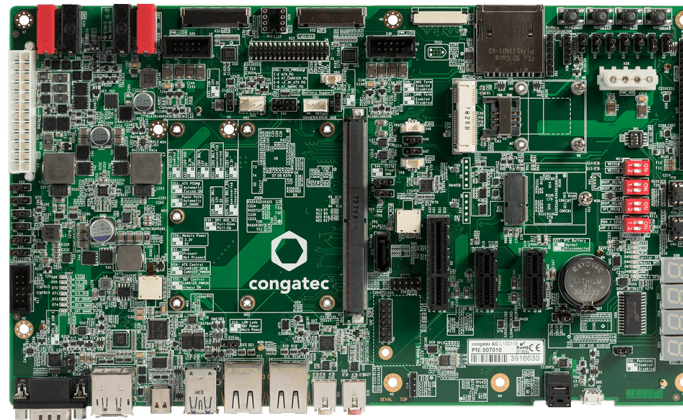

The information contained in this document has been carefully researched and is, to the best of our knowledge, accurate. However, we assume no liability for any product failures or damages, immediate or consequential, resulting from the use of the information provided herein. Our products are not intended for use in systems in which failures of product could result in personal injury. All trademarks mentioned herein are property of their respective owners. All specifications are subject to change without notice.

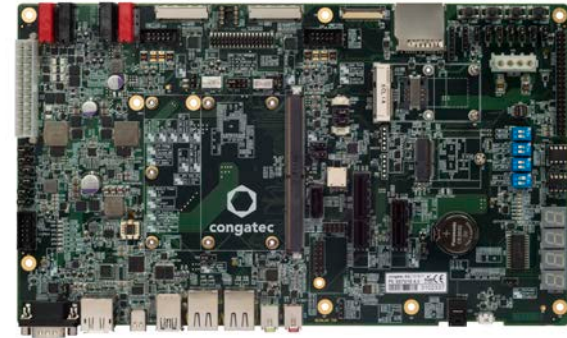

SMARC[®] 2.0 conga-SEVAL

Detailed description of the congatec SMARC 2.0 evaluation carrier board

User's Guide

Revision 1.4

Revision History

Revision	Date (yyyy-mm-dd)	Author	Changes
0.1	2017-07-05	AEM	<ul style="list-style-type: none">• Preliminary release
1.0	2017-10-04	AEM	<ul style="list-style-type: none">• Corrected the input voltage for connector M24 in table 3 "Connector M23-M24 Descriptions"• Official release
1.1	2019-01-25	AEM	<ul style="list-style-type: none">• Updated the information about handling electrostatic sensitive devices in preface section• Updated section 4.4 "Universal Serial Bus (USB)"• Corrected typographical error in table 18 "DIP Switch M18 Pinout Description"• Re-arranged the sections
1.2	2020-07-03	AEM	<ul style="list-style-type: none">• Added note about high-speed SD cards in section 4.16 "SD Card Slot"• Deleted section 7 "Industry Specifications"
1.3	2020-12-08	AEM	<ul style="list-style-type: none">• Restructured the whole document• Rearranged table 46 "Connector X17 Pinout Description"
1.4	2021-07-31	AEM	<ul style="list-style-type: none">• Updated document to hardware revision C.x• Changed congatec AG to congatec GmbH• Added Software License Information• Added section 5.7 "Module Detection - Internal Use Only"• Added section 5.8 "Optional HDMI Recording"• Corrected table 26 "Connector X13 Pinout Description"

Preface

This user's guide provides information about the components, features and connectors available on the congatec SMARC® 2.0 evaluation carrier board.

Software Licenses

Notice Regarding Open Source Software

The congatec products contain Open Source software that has been released by programmers under specific licensing requirements such as the "General Public License" (GPL) Version 2 or 3, the "Lesser General Public License" (LGPL), the "ApacheLicense" or similar licenses.

You can find the specific details at <https://www.congatec.com/en/licenses/>. Search for the revision of the BIOS/UEFI or Board Controller Software (as shown in the POST screen or BIOS setup) to get the complete product related license information. To the extent that any accompanying material such as instruction manuals, handbooks etc. contain copyright notices, conditions of use or licensing requirements that contradict any applicable Open Source license, these conditions are inapplicable.

The use and distribution of any Open Source software contained in the product is exclusively governed by the respective Open Source license. The Open Source software is provided by its programmers without ANY WARRANTY, whether implied or expressed, of any fitness for a particular purpose, and the programmers DECLINE ALL LIABILITY for damages, direct or indirect, that result from the use of this software.

OEM/ CGUTL BIOS

BIOS/UEFI modified by customer via the congatec System Utility (CGUTL) is subject to the same license as the BIOS/UEFI it is based on. You can find the specific details at <https://www.congatec.com/en/licenses/>.

Disclaimer

The information contained within this user's guide, including but not limited to any product specification, is subject to change without notice.

congatec GmbH provides no warranty with regard to this user's guide or any other information contained herein and hereby expressly disclaims any implied warranties of merchantability or fitness for any particular purpose with regard to any of the foregoing. congatec GmbH assumes no liability for any damages incurred directly or indirectly from any technical or typographical errors or omissions contained herein or for discrepancies between the product and the user's guide.

In no event shall congatec GmbH be liable for any incidental, consequential, special, or exemplary damages, whether based on tort, contract or otherwise, arising out of or in connection with this user's guide or any other information contained herein or the use thereof.

Intended Audience

This user's guide is intended for technically qualified personnel. It is not intended for general audiences.

Lead-Free Designs (RoHS)

All congatec GmbH designs are created from lead-free components and are completely RoHS compliant.

Electrostatic Sensitive Device



All congatec GmbH products are electrostatic sensitive devices. They are enclosed in static shielding bags, and shipped enclosed in secondary packaging (protective packaging). The secondary packaging does not provide electrostatic protection.

Do not remove the device from the static shielding bag or handle it, except at an electrostatic-free workstation. Also, do not ship or store electronic devices near strong electrostatic, electromagnetic, magnetic, or radioactive fields unless the device is contained within its original packaging. Be aware that failure to comply with these guidelines will void the congatec GmbH Limited Warranty.

Copyright Notice

Copyright © 2017, congatec GmbH. All rights reserved. All text, pictures and graphics are protected by copyrights. No copying is permitted without written permission from congatec GmbH.

congatec GmbH has made every attempt to ensure that the information in this document is accurate yet the information contained within is supplied "as-is".

Trademarks

Product names, logos, brands, and other trademarks featured or referred to within this user's guide, or the congatec website, are the property of their respective trademark holders. These trademark holders are not affiliated with congatec GmbH, our products, or our website.

Symbols

The following symbols are used in this user's guide:



Warning

Warnings indicate conditions that, if not observed, can cause personal injury.



Caution

Cautions warn the user about how to prevent damage to hardware or loss of data.



Note

Notes call attention to important information that should be observed.



Connector Type

Describes the connector on the congatec SMARC® evaluation carrier board.



Link to connector layout diagram

This link icon is located in the top left corner of each page. It provides a direct link to the connector layout in section 2 "Connector Layout".

Certification

congatec GmbH is certified to DIN EN ISO 9001 standard.



Technical Support

congatec GmbH technicians and engineers are committed to providing the best possible technical support for our customers so that our products can be easily used and implemented. We request that you first visit our website at www.congatec.com for the latest documentation, utilities and drivers, which have been made available to assist you. If you still require assistance after visiting our website then contact our technical support department by email at support@congatec.com

Warranty

congatec GmbH makes no representation, warranty or guaranty, express or implied regarding the products except its standard form of limited warranty ("Limited Warranty") per the terms and conditions of the congatec entity, which the product is delivered from. These terms and conditions can be downloaded from www.congatec.com. congatec GmbH may in its sole discretion modify its Limited Warranty at any time and from time to time.

The products may include software. Use of the software is subject to the terms and conditions set out in the respective owner's license agreements, which are available at www.congatec.com and/or upon request.

Beginning on the date of shipment to its direct customer and continuing for the published warranty period, congatec GmbH represents that the products are new and warrants that each product failing to function properly under normal use, due to a defect in materials or workmanship or due to non conformance to the agreed upon specifications, will be repaired or exchanged, at congatec's option and expense.

Customer will obtain a Return Material Authorization ("RMA") number from congatec GmbH prior to returning the non conforming product freight prepaid. congatec GmbH will pay for transporting the repaired or exchanged product to the customer.

Repaired, replaced or exchanged product will be warranted for the repair warranty period in effect as of the date the repaired, exchanged or replaced product is shipped by congatec, or the remainder of the original warranty, whichever is longer. This Limited Warranty extends to congatec's direct customer only and is not assignable or transferable.

Except as set forth in writing in the Limited Warranty, congatec makes no performance representations, warranties, or guarantees, either express or implied, oral or written, with respect to the products, including without limitation any implied warranty (a) of merchantability, (b) of fitness for a particular purpose, or (c) arising from course of performance, course of dealing, or usage of trade.

congatec GmbH shall in no event be liable to the end user for collateral or consequential damages of any kind. congatec shall not otherwise be liable for loss, damage or expense directly or indirectly arising from the use of the product or from any other cause. The sole and exclusive remedy against congatec, whether a claim sound in contract, warranty, tort or any other legal theory, shall be repair or replacement of the product only.

Terminology

Term	Description
PCIe	Peripheral Component Interface Express (PCI Express)
SDIO	Secure Digital Input Output
USB	Universal Serial Bus
SATA	Serial AT Attachment
HDA	High Definition Audio
HDMI	High Definition Multimedia Interface
DP	DisplayPort
eDP	Embedded DisplayPort
DSI	Display Serial Interface
MIPI	Mobile Industry Processor Interface
CSI	Camera Serial Interface
PTP	Precision Time Protocol
PWM	Pulse Width Modulation
I ² C Bus	Inter-Integrated Circuit Bus
SPI	Serial Peripheral Interface
eSPI	Enhanced Serial Peripheral Interface
JTAG	Joint Test Action Group
GbE	Gigabit Ethernet
LVDS	Low-Voltage Differential Signaling
DDC	Display Data Channel
N.C.	Not connected
N.A.	Not available or not applicable
TBD	To be determined

Contents

1	Introduction	11	4.2.4.2	LVDS / DSI.....	33
1.1	SMARC® Concept	11	4.2.4.3	Flat Panel and Backlight Power Supply.....	34
1.2	conga-SEVAL	11	4.2.4.4	Flat Panel and Backlight Voltage Selection	34
2	Connector Layout	12	4.3	MIPI-CSI	36
3	Specifications	13	4.4	Universal Serial Bus (USB)	37
3.1	Mechanical Dimensions	13	4.4.1	Micro USB Type-AB (OTG).....	37
3.2	Environmental Specifications	13	4.4.2	Dual Stacked USB Type-A	38
3.3	Power Supply	13	4.4.3	USB Type-C.....	38
3.3.1	ATX / AT Power Supply.....	14	4.5	SATA	39
3.3.2	DC Power Supply	15	4.6	HDD Power Connector	39
3.3.3	USB Type-C Power Delivery	16	4.7	Gigabit Ethernet (GbE)	40
3.4	Jumper Settings for Power Options	16	4.8	Audio Interfaces.....	41
3.4.1	Runtime Voltage Control	16	4.8.1	MIC-IN	41
3.4.2	Standby Voltage Control.....	17	4.8.2	Line-OUT.....	42
3.4.3	Supply Voltage for Module	17	4.8.3	S/PDIF OUT	42
3.4.4	Power Monitoring (VIN_PWRBAD#).....	18	4.9	I2S Bus	43
3.4.5	Module Power Path	18	4.10	CAN Bus	43
3.5	Status LEDs D68 - D71, D73 - D75	19	4.11	I2C Bus.....	44
3.6	SMARC Battery Support Signals.....	19	4.11.1	General Purpose I2C.....	44
3.7	CMOS Battery.....	20	4.11.2	Power Management I2C	45
4	Connector Subsystem.....	21	4.12	eSPI / SPI1.....	45
4.1	PCIe	26	4.12.1	SPI.....	46
4.1.1	PCIe x4 Slot.....	27	4.13	Boot Selection	47
4.1.2	Mini PCIe.....	27	4.14	Force Recovery	47
4.1.3	PCIe x1 Slot.....	27	4.15	SIM Card Slot.....	48
4.1.4	M.2.....	28	4.16	SD Card Slot	48
4.2	Display Interfaces.....	29	4.17	Serial Ports	49
4.2.1	DisplayPort++	29	4.17.1	COM Port 0.....	49
4.2.2	HDMI	30	4.17.2	COM Port 1.....	50
4.2.3	USB Type C Alternate Display Mode	30	4.17.3	COM Port 2.....	50
4.2.4	LVDS / DSI / eDP.....	31	4.17.4	COM Port 3.....	50
4.2.4.1	eDP	31	4.18	FAN.....	51
			5	Additional Features.....	52
			5.1	Buttons.....	52

5.1.1	Power.....	52
5.1.2	Reset.....	52
5.1.3	LID.....	52
5.1.4	Sleep.....	53
5.2	Ground Test Points.....	53
5.3	Feature Connector.....	53
5.4	Debug Display Port.....	55
5.5	GPIO.....	55
5.6	JTAG (Debug Feature) - Internal Use Only.....	56
5.7	Module Detection - Internal Use Only.....	57
5.8	Optional HDMI Recording.....	57
6	Mechanical Dimensions.....	58



List of Tables

Table 1	ATX Power (Connector X51) Pinout Description.....	14	Table 37	DIP Switch SW1 Description	44
Table 2	Jumper X53 Description	14	Table 38	Connector CN2 Description	45
Table 3	Connector M23-M24 Description	15	Table 39	DIP Switch M18 Pinout Description	46
Table 4	Connector M25-M26 Description	15	Table 40	Connector X39 Pinout Description	46
Table 5	Jumper X55 Description	17	Table 41	DIP Switch M17 / M18 Description.....	47
Table 6	Jumper X59 Description	17	Table 42	Jumper X45 Description	47
Table 7	Jumper X60 Description	18	Table 43	Connector X8 Pinout Description	48
Table 8	Jumper X61 Description	18	Table 44	Connector CN1 Pinout Description	48
Table 9	Status LEDs Description.....	19	Table 45	Connector X18 Pinout Description	49
Table 10	Jumper X52 Description	19	Table 46	Connector X17 Pinout Description	50
Table 11	CN3 Description	19	Table 47	Connector X42 Pinout Description	51
Table 12	Jumper X57 Description	20	Table 48	Jumper X43 Description	51
Table 13	SMARC Edge Finger Connector Pinout.....	21	Table 49	Connector X37 Description	53
Table 14	DIP Switch M11 Description	28	Table 50	Jumper X56 Description	55
Table 15	Jumper X34 Pin Description	30	Table 51	GPIO Alternate Function and Routing.....	55
Table 16	Jumper X34 Pin Description	30	Table 52	Jumper X40 Description	56
Table 17	Jumper X35 Pin Description	31	Table 53	GPIO Connector X38 Description.....	56
Table 18	DIP M12 Pinout Description	31	Table 54	Jumper X44 Description	56
Table 19	Connector X31 / X32 Pinout Description.....	32	Table 55	Connector X62 Description	57
Table 20	Connector X31 / X32 Pinout Description.....	33	Table 56	Jumper X65 Description	57
Table 21	Connector X23 Pinout Description	33			
Table 22	Connector X26 / X30 Pinout Description.....	34			
Table 23	Jumper X22 / X27 Pinout Description	35			
Table 24	Jumper X25 / X28 Pinout Description	35			
Table 25	Jumper X24 / X29 Pinout Description	35			
Table 26	Connector X13 Pinout Description	36			
Table 27	Connector X50 Description	39			
Table 28	Connector X58 Description	39			
Table 29	Connector X14 Pinout Description	40			
Table 30	Jumper X16 Description	40			
Table 31	I2S or HDA Codec Selection.....	41			
Table 32	MIC-IN (Connector X19) Pinout Description.....	41			
Table 33	Line_OUT (Connector X21) Pinout Description	42			
Table 34	SPDIF-OUT (Connector X20) Pinout Description	42			
Table 35	Connector X46 Description	43			
Table 36	Jumper X47/X49 Description.....	43			



1 Introduction

1.1 SMARC® Concept

The Standardization Group for Embedded Technologies e.V (SGET) defined the SMARC standard for small form factor computer modules that target applications with ultra low power, low cost and high performance. The SMARC connector and interfaces are optimized for high-speed communication, and are suitable for ARM SoCs and low power x86 SoCs.

The SMARC standard bridges the gap between the COM Express standard and the Qseven standard by offering most of the interfaces defined in the COM Express specification at a lower power—between 2 W and 6 W during active operation. With a footprint of 82 mm x 50 mm or 82 mm x 80 mm, the SMARC standard promotes the design of highly integrated, energy efficient systems.

Due to its small size and lower power demands, PC appliance designers can design low cost devices as well as explore a huge variety of product development options—from compact space-saving designs to fully functional systems. This solution allows scalability, product diversification and faster time to market.

1.2 conga-SEVAL

The conga-SEVAL is designed based on the SMARC Design Guide Specification. By providing most of the functional requirement for any SMARC application, the conga-SEVAL carrier board provides manufacturers and developers with a platform to jump-start the development of systems and applications based on SMARC specification. This solution helps to reduce product design cycle and encourages rapid innovation in system design, to meet the ever-changing needs of the market.

The conga-SEVAL supports both 82 mm x 50 mm and 82 mm x 80 mm SMARC modules and can be used for:

- validating SMARC module
- evaluating customer platform
- debugging or testing production platform
- reference purpose



2 Connector Layout

The connector layout picture below shows each connector and its name designator. Jumpers and their respective pins are also shown. Select the Adobe 'Zoom-In-Tool' and zoom in on a given component to see its designator. Hover over the component and the 'Zoom-In-Tool' will change indicating there is a link. Click on the link to navigate to the area in the document where the component is described. Use the mouse icon in the top left hand corner of the destination page to return to the connector layout picture.

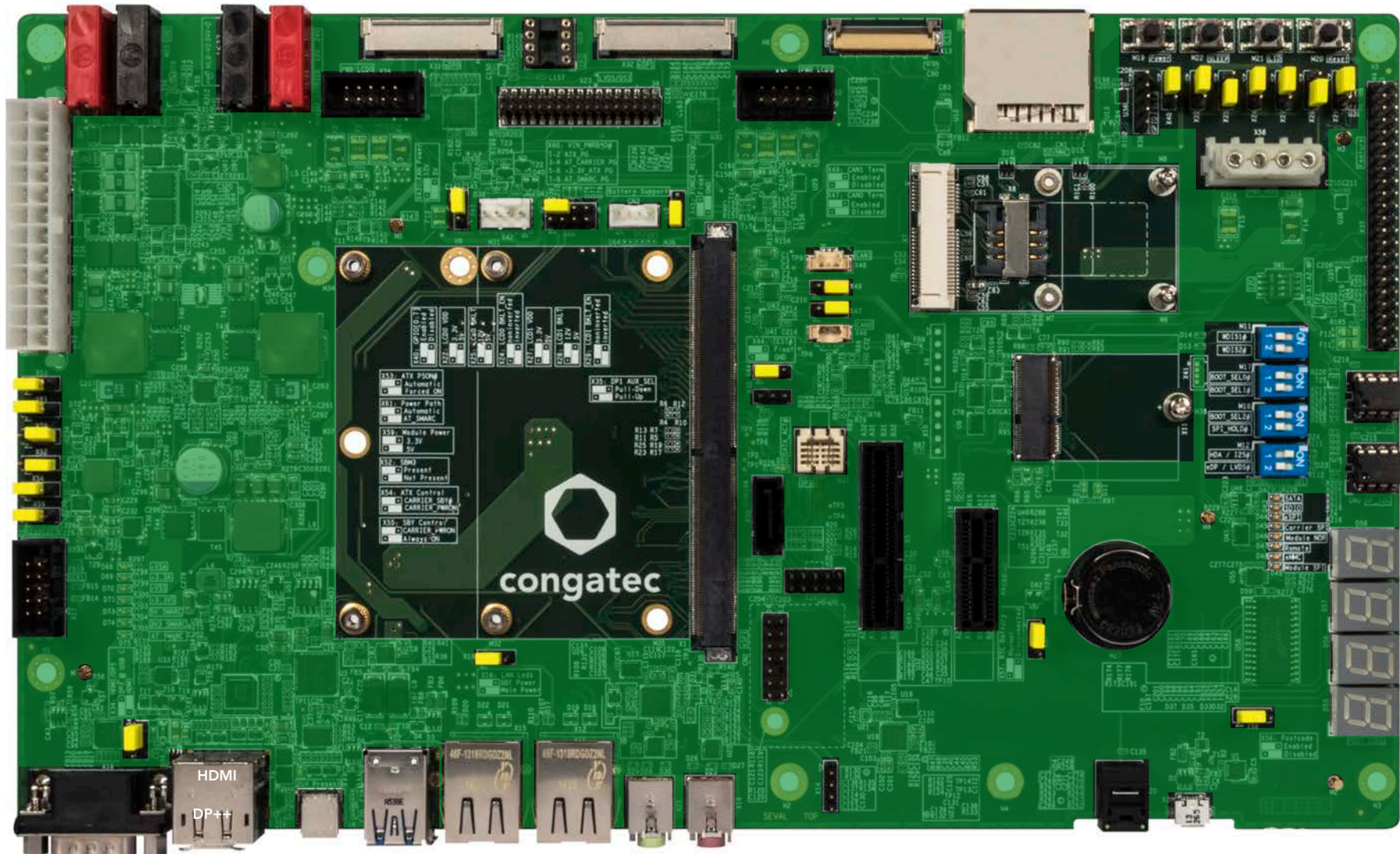



3 Specifications

3.1 Mechanical Dimensions

- 294 mm x 172 mm
- Height approximately 25 mm (top side)

3.2 Environmental Specifications

Temperature	Operation: 0° to 60°C	Storage: -40° to +85°C (commercial temperature)
Temperature	Operation: -40° to 85°C	Storage: -40° to +85°C (industrial temperature)
Humidity	Operation: 10% to 90%	Storage: 5% to 95%



Note

The above operating temperatures must be strictly adhered to at all times. The maximum operating temperature refers to any measurable spot on the modules surface. Humidity specifications are for non-condensing conditions.

3.3 Power Supply

The conga-SEVAL supports the following power sources:

- standard 24-pin ATX power supply (connector X51)
- 12 V - 24 V DC variable input power supply (connector M23, M24)
- 3 V - 5.25 V DC variable input power supply (connector M25, M26)
- USB Type-C Power Delivery (12 V - 20 V)



3.3.1 ATX / AT Power Supply

With an ATX power supply, the SMARC® module starts after the power-on button M19 is pressed. To force the ATX power supply to always be on, set jumper X53 to position 2-3. This setting is ideal for debugging purposes.

Table 1 ATX Power (Connector X51) Pinout Description

Pin	Signal	Description	Pin	Signal	Description
1	+3.3V	Power Supply +3.3 VDC	13	+3.3V	Power Supply +3.3 VDC
2	+3.3V	Power Supply +3.3 VDC	14	-12V	Power Supply -12 VDC
3	GND	Power Ground	15	GND	Power Ground
4	+5V	Power Supply +5 VDC	16	PS_ON#	Power Supply On (active low). Short this pin to GND to switch power supply ON, disconnect from GND to switch OFF.
5	GND	Power Ground	17	GND	Power Ground
6	+5V	Power Supply +5 VDC	18	GND	Power Ground
7	GND	Power Ground	19	GND	Power Ground
8	PWR_OK	Power Ok	20	N.C	Not connected
9	5V_SB	Standby Power Supply +5 VDC	21	+5V	Power Supply +5 VDC
10	+12V	Power Supply +12 VDC	22	+5V	Power Supply +5 VDC
11	+12V	Power Supply +12 VDC	23	+5V	Power Supply +5 VDC
12	+3.3V	Power Supply +3.3 VDC	24	GND	Power Ground

ATX Power Connector X51

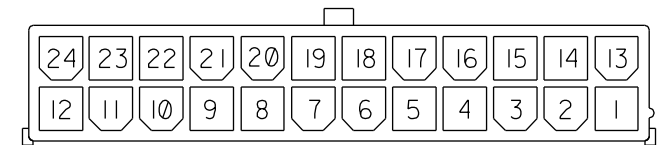

Table 2 Jumper X53 Description

Pin	Configuration
1-2	ATX Mode (Default)
2-3	ATX PSU always on

Jumper X53



Connector Type

X51: ATX 2.0 Power Connector

X53: 2.54 mm grid jumper



3.3.2 DC Power Supply

The conga-SEVAL features the following connectors for DC power supply:

- 12V - 24V DC power supply via connectors M23 and M24
 - supplies power to the carrier board and module
- 3V - 5.25V DC power supply via connectors M25 and M26.
 - supplies power to only the SMARC module

Table 3 Connector M23-M24 Description

Connector	Description
M23	Ground
M24	Carrier board input voltage (12 – 24V)

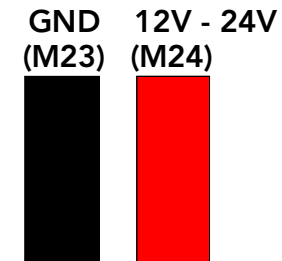
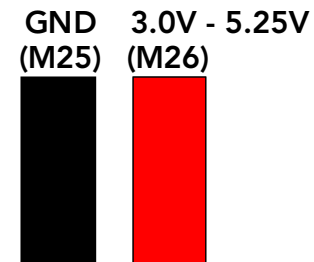

Table 4 Connector M25-M26 Description

Connector	Description
M25	Ground
M26	SMARC module input voltage (3.0V – 5.25V)



Connector Type

M23 - M26: 4 mm banana plug



3.3.3 USB Type-C Power Delivery

The conga-SEVAL can be powered by a USB Type-C device attached to connector X4. The USB Type-C port supports USB power delivery up to 20 V @ 5 A. The port delivers 20 V only when the carrier board receives an input voltage of 20 V. In this mode, the LED D10 glows.

If the input voltage is lower than 20 V, the port provides 12 V or 5 V or both depending on the power delivery profile negotiated with the USB Type C sink.

USB Type-C - X4

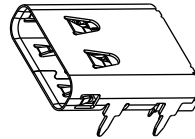

D10



Connector Type

X4: USB Type-C receptacle

3.4 Jumper Settings for Power Options

3.4.1 Runtime Voltage Control

Use jumper X54 to select the SMARC signal that should enable the runtime voltage of the conga-SEVAL.

Jumper X54 Description

Pin	Configuration
1-2	CARRIER_STBY# signal enables carrier board runtime voltages (default)
2-3	CARRIER_PWRON signal enables carrier board runtime voltages

Jumper X54

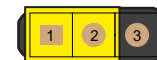

Connector Type

X54: 2.54 mm grid jumper



3.4.2 Standby Voltage Control

Use jumper X55 to select how the conga-SEVAL standby voltages are controlled.

Table 5 Jumper X55 Description

Pin	Configuration
1-2	CARRIER_PWRON signal controls the carrier board standby voltages
2-3	Carrier board standby voltages are always enabled

Jumper X55



Connector Type

X55: 2.54 mm grid jumper

3.4.3 Supply Voltage for Module

Use jumper X59 to set the module's input voltage to 3.3 V or 5 V.



Note

Jumper X59 has no effect if the module's voltage is supplied by connectors M25 and M26.

Table 6 Jumper X59 Description

Pin	Configuration
1-2	3.3 V
2-3	5 V

Jumper X59

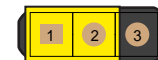

Connector Type

X59: 2.54 mm grid jumper



3.4.4 Power Monitoring (VIN_PWRBAD#)

Use jumper X60 to select the power rail that notifies the module that the operating voltages are within ranges required for operation.

Table 7 Jumper X60 Description

Pin	Configuration
1-2	5 V ATX power good signal (only for debugging)
3-4	Carrier board power good signal (M23, M24)
5-6	+3.3V ATX power good signal
7-8	Module power good signal (M25, M26)
2-4	No VIN PWRBAD# control

Jumper X60



Connector Type

X60: 2.54 mm, 2x4 pin header

3.4.5 Module Power Path

When you power the module via M25 and M26, use jumper X61 to configure how the conga-SEVAL handles the switching of the module's power path.

Note

Setting jumper X61 to position 2-3 switches the module's power path to connector M25 and M26, even if the conga-SEVAL is powered via M23 and M24.

Table 8 Jumper X61 Description

Pin	Configuration
1-2	Automatic
2-3	AT_SMARC

Jumper X61



Connector Type

X61: 2.54 mm grid jumper



3.5 Status LEDs D68 - D71, D73 - D75

LEDs D68 - D71 indicate the status of the power rails on the conga-SEVAL. LEDs D73 - D75 indicate the voltage source for the SMARC module. The description of the LEDs is shown in the table below:

Table 9 Status LEDs Description

LED	Power State
D68	5 V standby voltage on conga-SEVAL
D69	3.3 V standby voltage on conga-SEVAL
D70	5 V runtime voltage on conga-SEVAL
D71	3.3 V runtime voltage on conga-SEVAL
D73	5 V supplied from conga-SEVAL 5 V DC/DC to SMARC module
D74	3.3 V supplied from conga-SEVAL 3.3 V DC/DC to SMARC module
D75	3.0 V – 5.25 V supplied via connectors M25 and M26 to SMARC module

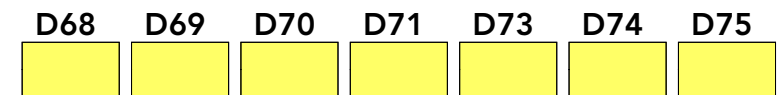

3.6 SMARC Battery Support Signals

The conga-SEVAL provides SMARC battery support signals on connector CN3. Set jumper X52 to position 1-2 if a smart battery system is connected to conga-SEVAL. This setting ensures the conga-SEVAL enables the necessary DC/DC voltage regulators.

Table 10 Jumper X52 Description

Pin	Configuration
1-2	SBM3 present
2-3	SBM3 not present

Jumper X52



Table 11 CN3 Description

Pin	Signal
1	CHARGING#
2	CHARGER_PRSENT#
3	BATLOW#
4	GND

CN3 - Battery Support

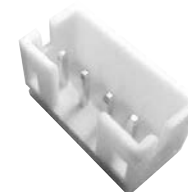



Connector Type

CN3: 2.00 mm, 1 x 4 box header

X52: 2.54 mm grid jumper

3.7 CMOS Battery

The conga-SEVAL provides a board-mounted battery holder (M27) for a CMOS battery. The CMOS battery supplies the power required to maintain the module's RTC and CMOS memory. The required battery type on the conga-SEVAL is CR2032.

Set jumper X57 to position 2-3 to disconnect the RTC battery.



Warning

Danger of explosion if battery is incorrectly replaced. Replace only with the same or equivalent type recommended by the manufacturer. Dispose of used batteries according to the manufacturer's instructions.

Table 12 Jumper X57 Description

Pin	Configuration
1 - 2	Connect RTC battery (default)
2 - 3	Disconnect RTC battery

Connector Type

X57: 2.54 mm grid jumper

Jumper X57

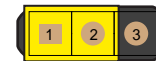

CMOS Battery - M27

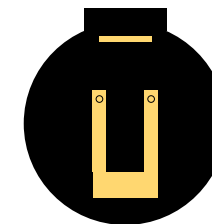



4 Connector Subsystem

Table 13 SMARC Edge Finger Connector Pinout

P-PIN	Primary (Top) Side	S-Pin	Secondary (Bottom) Side
		S1	CSI1_TX+ / I2C_CAM1_CK
P1	SMB_ALERT_1V8#	S2	CSI1_TX- / I2C_CAM1_DAT
P2	GND	S3	GND
P3	CSI1_CK+	S4	RSVD
P4	CSI1_CK-	S5	CSI0_TX- / I2C_CAM0_CK
P5	GBE1_SDP	S6	CAM_MCK
P6	GBE0_SDP	S7	CSI0_TX+ / I2C_CAM0_DAT
P7	CSI1_RX0+	S8	CSI0_CK+
P8	CSI1_RX0-	S9	CSI0_CK-
P9	GND	S10	GND
P10	CSI1_RX1+	S11	CSI0_RX0+
P11	CSI1_RX1-	S12	CSI0_RX0-
P12	GND	S13	GND
P13	CSI1_RX2+	S14	CSI0_RX1+
P14	CSI1_RX2-	S15	CSI0_RX1-
P15	GND	S16	GND
P16	CSI1_RX3+	S17	GBE1_MDI0+
P17	CSI1_RX3-	S18	GBE1_MDI0-
P18	GND	S19	GBE1_LINK100#
P19	GBE0_MDI3-	S20	GBE1_MDI1+
P20	GBE0_MDI3+	S21	GBE1_MDI1-
P21	GBE0_LINK100#	S22	GBE1_LINK1000#
P22	GBE0_LINK1000#	S23	GBE1_MDI2+
P23	GBE0_MDI2-	S24	GBE1_MDI2-
P24	GBE0_MDI2+	S25	GND
P25	GBE0_LINK_ACT#	S26	GBE1_MDI3+
P26	GBE0_MDI1-	S27	GBE1_MDI3-
P27	GBE0_MDI1+	S28	GBE1_CTREF
P28	GBE0_CTREF	S29	PCIE_D_TX+



P-PIN	Primary (Top) Side	S-Pin	Secondary (Bottom) Side
P29	GBE0_MDIO-	S30	PCIE_D_TX-
P30	GBE0_MDIO+	S31	GBE1_LINK_ACT#
P31	SPI0_CS1#	S32	PCIE_D_RX+
P32	GND	S33	PCIE_D_RX-
P33	SDIO_WP	S34	GND
P34	SDIO_CMD	S35	USB4+
P35	SDIO_CD#	S36	USB4-
P36	SDIO_CK	S37	USB3_VBUS_DET
P37	SDIO_PWR_EN	S38	AUDIO_MCK
P38	GND	S39	I2S0_LRCK
P39	SDIO_D0	S40	I2S0_SDOOUT
P40	SDIO_D1	S41	I2S0_SDIN
P41	SDIO_D2	S42	I2S0_CK
P42	SDIO_D3	S43	ESPI_ALERT0#
P43	SPI0_CS0#	S44	ESPI_ALERT1#
P44	SPI0_CK	S45	RSVD
P45	SPI0_DIN	S46	RSVD
P46	SPI0_DO	S47	GND
P47	GND	S48	I2C_GP_CK
P48	SATA_TX+	S49	I2C_GP_DAT
P49	SATA_TX-	S50	HDA_SYNC / I2S2_LRCK
P50	GND	S51	HDA_SDO / I2S2_SDOOUT
P51	SATA_RX+	S52	HDA_SDI / I2S2_SDIN
P52	SATA_RX-	S53	HDA_CK / I2S2_CK
P53	GND	S54	SATA_ACT#
P54	ESPI_CS0#	S55	USB5_EN_OC#
P55	ESPI_CS1#	S56	ESPI_IO_2
P56	ESPI_CK	S57	ESPI_IO_3
P57	ESPI_IO_1	S58	ESPI_RESET#
P58	ESPI_IO_0	S59	USB5+
P59	GND	S60	USB5-
P60	USB0+	S61	GND
P61	USB0-	S62	USB3_SSTX+



P-PIN	Primary (Top) Side	S-Pin	Secondary (Bottom) Side
P62	USB0_EN_OC#	S63	USB3_SSTX-
P63	USB0_VBUS_DET	S64	GND
P64	USB0_OTG_ID	S65	USB3_SSRX+
P65	USB1+	S66	USB3_SSRX-
P66	USB1-	S67	GND
P67	USB1_EN_OC#	S68	USB3+
P68	GND	S69	USB3-
P69	USB2+	S70	GND
P70	USB2-	S71	USB2_SSTX+
P71	USB2_EN_OC#	S72	USB2_SSTX-
P72	RSVD	S73	GND
P73	RSVD	S74	USB2_SSRX+
P74	USB3_EN_OC#	S75	USB2_SSRX-
	Key		Key
P75	PCIE_A_RST#	S76	PCIE_B_RST#
P76	USB4_EN_OC#	S77	PCIE_C_RST#
P77	RSVD	S78	PCIE_C_RX+
P78	RSVD	S79	PCIE_C_RX-
P79	GND	S80	GND
P80	PCIE_C_REFCK+	S81	PCIE_C_TX+
P81	PCIE_C_REFCK-	S82	PCIE_C_TX-
P82	GND	S83	GND
P83	PCIE_A_REFCK+	S84	PCIE_B_REFCK+
P84	PCIE_A_REFCK-	S85	PCIE_B_REFCK-
P85	GND	S86	GND
P86	PCIE_A_RX+	S87	PCIE_B_RX+
P87	PCIE_A_RX-	S88	PCIE_B_RX-
P88	GND	S89	GND
P89	PCIE_A_TX+	S90	PCIE_B_TX+
P90	PCIE_A_TX-	S91	PCIE_B_TX-
P91	GND	S92	GND



P-PIN	Primary (Top) Side	S-Pin	Secondary (Bottom) Side
P92	HDMI_D2+ / DP1_LANE0+	S93	DP0_LANE0+
P93	HDMI_D2- / DP1_LANE0-	S94	DP0_LANE0-
P94	GND	S95	DP0_AUX_SEL
P95	HDMI_D1+ / DP1_LANE1+	S96	DP0_LANE1+
P96	HDMI_D1- / DP1_LANE1-	S97	DP0_LANE1-
P97	GND	S98	DP0_HPD
P98	HDMI_D0+ / DP1_LANE2+	S99	DP0_LANE2+
P99	HDMI_D0- / DP1_LANE2-	S100	DP0_LANE2-
P100	GND	S101	GND
P101	HDMI_CK+ / DP1_LANE3+	S102	DP0_LANE3+
P102	HDMI_CK- / DP1_LANE3-	S103	DP0_LANE3-
P103	GND	S104	USB3_OTG_ID
P104	HDMI_HPD / DP1_HPD	S105	DP0_AUX+
P105	HDMI_CTRL_CK / DP1_AUX+	S106	DP0_AUX-
P106	HDMI_CTRL_DAT / DP1_AUX-	S107	LCD1_BKLT_EN
P107	DP1_AUX_SEL	S108	LVDS1_CK+ / eDP1_AUX+ / DSI1_CLK+
P108	GPIO0 / CAM0_PWR#	S109	LVDS1_CK- / eDP1_AUX- / DSI1_CLK-
P109	GPIO1 / CAM1_PWR#	S110	GND
P110	GPIO2 / CAM0_RST#	S111	LVDS1_0+ / eDP1_TX0+ / DSI1_D0+
P111	GPIO3 / CAM1_RST#	S112	LVDS1_0- / eDP1_TX0- / DSI1_D0-
P112	GPIO4 / HDA_RST#	S113	eDP1_HPD
P113	GPIO5 / PWM_OUT	S114	LVDS1_1+ / eDP1_TX1+ / DSI1_D1+
P114	GPIO6 / TACHIN	S115	LVDS1_1- / eDP1_TX1- / DSI1_D1-
P115	GPIO7	S116	LCD1_VDD_EN
P116	GPIO8	S117	LVDS1_2+ / eDP1_TX2+ / DSI1_D2+
P117	GPIO9	S118	LVDS1_2- / eDP1_TX2- / DSI1_D2-
P118	GPIO10	S119	GND
P119	GPIO11	S120	LVDS1_3+ / eDP1_TX3+ / DSI1_D3+
P120	GND	S121	LVDS1_3- / eDP1_TX3- / DSI1_D3-
P121	I2C_PM_CK	S122	LCD1_BKLT_PWM
P122	I2C_PM_DAT	S123	RSVD
P123	BOOT_SEL0#	S124	GND
P124	BOOT_SEL1#	S125	LVDS0_0+ / eDP0_TX0+ / DSI0_D0+



P-PIN	Primary (Top) Side	S-Pin	Secondary (Bottom) Side
P125	BOOT_SEL2#	S126	LVDS0_0- / eDP0_TX0- / DSI0_D0-
P126	RESET_OUT#	S127	LCD0_BKLT_EN
P127	RESET_IN#	S128	LVDS0_1+ / eDP0_TX1+ / DSI0_D1+
P128	POWER_BTN#	S129	LVDS0_1- / eDP0_TX1- / DSI0_D1-
P129	SER0_TX	S130	GND
P130	SER0_RX	S131	LVDS0_2+ / eDP0_TX2+ / DSI0_D2+
P131	SER0_RTS#	S132	LVDS0_2- / eDP0_TX2- / DSI0_D2-
P132	SER0_CTS#	S133	LCD0_VDD_EN
P133	GND	S134	LVDS0_CK+ / eDP0_AUX+ / DSI0_CLK+
P134	SER1_TX	S135	LVDS0_CK- / eDP0_AUX- / DSI0_CLK-
P135	SER1_RX	S136	GND
P136	SER2_TX	S137	LVDS0_3+ / eDP0_TX3+ / DSI0_D3+
P137	SER2_RX	S138	LVDS0_3- / eDP0_TX3- / DSI0_D3-
P138	SER2_RTS#	S139	I2C_LCD_CK
P139	SER2_CTS#	S140	I2C_LCD_DAT
P140	SER3_TX	S141	LCD0_BKLT_PWM
P141	SER3_RX	S142	RSVD
P142	GND	S143	GND
P143	CAN0_TX	S144	eDP0_HPD
P144	CAN0_RX	S145	WDT_TIME_OUT#
P145	CAN1_TX	S146	PCIE_WAKE#
P146	CAN1_RX	S147	VDD_RTC
P147	VDD_IN	S148	LID#
P148	VDD_IN	S149	SLEEP#
P149	VDD_IN	S150	VIN_PWR_BAD#
P150	VDD_IN	S151	CHARGING#
P151	VDD_IN	S152	CHARGER_PRSN#
P152	VDD_IN	S153	CARRIER_STBY#
P153	VDD_IN	S154	CARRIER_PWR_ON
P154	VDD_IN	S155	FORCE_RECOV#
P155	VDD_IN	S156	BATLOW#
P156	VDD_IN	S157	TEST#
		S158	GND



4.1 PCIe

The conga-SEVAL provides four PCIe interfaces:

- PCIe x4 slot on connector X5
- PCIe x1 slot on connector X9
- mini-PCIe slot on connector X7
- M.2 slot on connector X11

The PCIe lanes are routed as shown below.

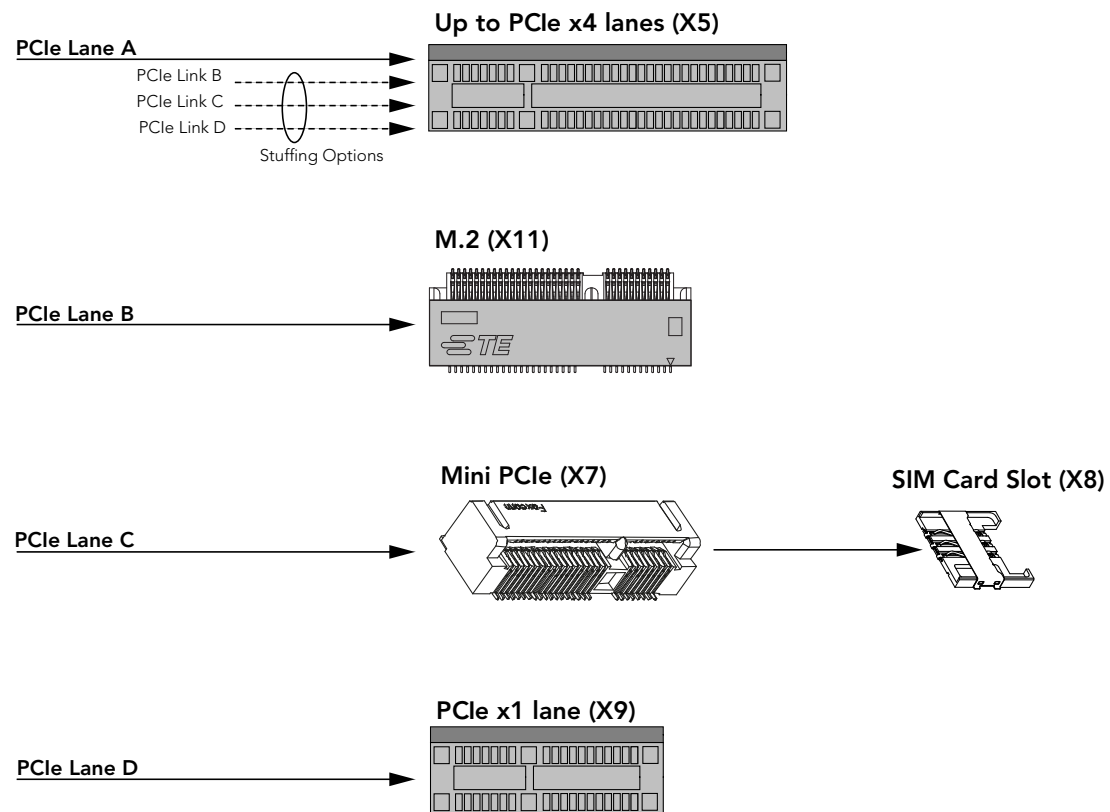



4.1.1 PCIe x4 Slot

The conga-SEVAL provides a PCIe x4 slot on connector X5. This slot supports only one PCIe lane by default. With BOM option, the connector can support up to four PCIe lanes.

PCIe x4 - X5

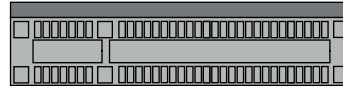

Connector Type

X5: PCIe x4 card

4.1.2 Mini PCIe

The conga-SEVAL provides a mini PCIe slot on connector X7.

Mini PCIe - Connector X7

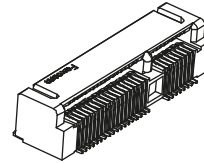

Connector Type

X7: Mini PCIe card

4.1.3 PCIe x1 Slot

The conga-SEVAL provides a PCIe x1 slot on connector X9.

PCIe x1 - X9

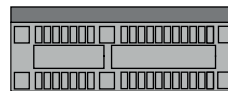

Connector Type

X9: PCIe x1 card



4.1.4 M.2

The conga-SEVAL provides an M.2 Key E slot (X11) for connecting Wifi, NFC, GNSS and Bluetooth devices. The M.2 connector (X11):

- supports multiple I/O interfaces such as USB, PCIe, SDIO, I²C, I²S, UART
- shares the SDIO signals with the SD card slot (CN1)
- shares the UART signals with the feature connector (X37)

Use DIP Switch M11 to enable or disable attached wireless device. The LEDs D11 and D12 lit when the wireless device is enabled.



1. SDIO based cards will not function on the M.2 connector if an SD card is inserted into connector CN1.
2. UART devices on the feature connector will not function if any card is inserted into the M.2 connector.

Table 14 DIP Switch M11 Description

DIP Switch		Configuration
SW 1	SW 2	
OFF	OFF	Disable all radio interfaces on M.2 card
ON	OFF	Enable first radio interface on M.2 card (W_DISABLE1#, usually Wifi)
OFF	ON	Enable second radio interface on M.2 card (W_DISABLE2#, usually bluetooth)
ON	ON	Enable all radio interfaces on M.2 card

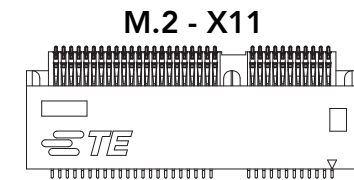
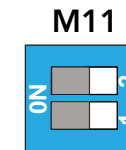

Connector Type

X11: M.2 Key E slot (compatible with card size 1630, 2230 and 3030)



4.2 Display Interfaces

The conga-SEVAL provides the following display interfaces:

- Dual mode DisplayPort (DP++) on connector X33 (upper port)
- Native HDMI on connector X33 (lower port)
- DisplayPort alternate mode on USB Type C connector X4
- eDP / LVDS / DSI
 - eDP on connector X31 or X32 or both
 - LVDS / DSI on connector X23

4.2.1 DisplayPort++

The conga-SEVAL routes the first DisplayPort (DP0) signals of a SMARC module directly to connector X33 (upper port). The connector supports dual mode DisplayPort.

X33 - Stacked DP++ and HDMI

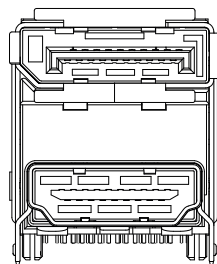

Connector Type

X33: DP/HDMI cable



4.2.2 HDMI

The conga-SEVAL supports an HDMI port on connector X33 (lower port). To use this port:

- the attached SMARC module must support native HDMI functionality
- set jumper X34 to position 2-3

Table 15 Jumper X34 Pin Description

Pin	Configuration
1-2	DisplayPort on USB Type-C connector (X4)
2-3	HDMI (default)



Connector Type

X33: DP/HDMI cable

X34: 2.54 mm grid jumper

X33 - Stacked DP++ and HDMI

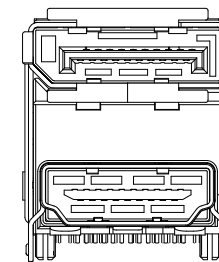

Jumper X34



4.2.3 USB Type C Alternate Display Mode

The conga-SEVAL supports DisplayPort on USB Type C connector (X4). This feature is available only if the attached SMARC module supports native DisplayPort signals on its second DisplayPort (DP1) interface.

For DisplayPort functionality on USB Type_C connector:

- set jumper X35 to position 1-2
- set jumper X34 to position 1-2.

Table 16 Jumper X34 Pin Description

Pin	Configuration
1-2	DisplayPort on USB Type-C connector (X4)
2-3	HDMI

Jumper X34

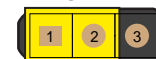

USB Type-C - X4

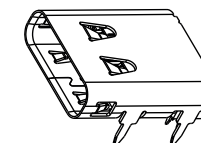
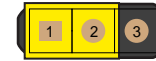



Table 17 Jumper X35 Pin Description

Pin	Configuration
1-2	DisplayPort AUX
2-3	HDMI DDC

Jumper X35



 Connector Type

X4: USB Type-C Receptacle

X34, X35: 2.54 mm grid jumper

4.2.4 LVDS / DSI / eDP

The conga-SEVAL supports the following LCD panels:

- eDP panel on connector X31 and X32
- dual channel LVDS panel (or DSI display) on connector X23

4.2.4.1 eDP

The conga-SEVAL provides two eDP interfaces—on connectors X31 and X32. To use these connectors for eDP:

- the SMARC module must support eDP signals
- set switch 2 of DIP switch M12 to ON position

Table 18 DIP M12 Pinout Description

Dip Switch M12		Configuration
SW 1	SW 2	
N.A	ON	eDP selection
N.A	OFF	LVDS / DSI selection

M12

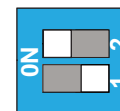
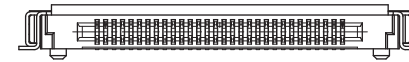



Table 19 Connector X31 / X32 Pinout Description

Pin	Signal	Pin	Signal
1	N.C.	21	VCC_EDP_FILT
2	GND	22	N.C.
3	eDP[0:1]_TX3-	23	GND
4	eDP[0:1]_TX3+	24	GND
5	GND	25	GND
6	eDP[0:1]_TX2-	26	GND
7	eDP[0:1]_TX2+	27	eDP[0:1]_HPD
8	GND	28	GND
9	eDP[0:1]_TX1-	29	GND
10	eDP[0:1]_TX1+	30	GND
11	GND	31	GND
12	eDP[0:1]_TX0-	32	eDP[0:1]_LVDS_BKLT_EN
13	eDP[0:1]_TX0+	33	eDP[0:1]_LVDS_BKLT_CTRL
14	GND	34	N.C.
15	eDP[0:1]_AUX+	35	N.C.
16	eDP[0:1]_AUX-	36	N.C.
17	GND	37	BKLT_PWR
18	VCC_EDP_FILT	38	BKLT_PWR
19	VCC_EDP_FILT	39	BKLT_PWR
20	VCC_EDP_FILT	40	N.C.

eDP Connector - X31 / X32



 Connector Type

X31, X32: 0.5mm , 40 Pos. ACES connector



4.2.4.2 LVDS / DSI

The conga-SEVAL supports a dual channel LVDS interface or a MIPI DSI interface on connector X23. To use connector X23 for LVDS display or DSI display:

- the SMARC module must support LVDS or DSI signals
- set switch 2 of DIP switch M12 to OFF position

Table 20 Connector X31 / X32 Pinout Description

Dip Switch M12		Configuration
SW 1	SW 2	
N.A	ON	eDP selection
N.A	OFF	LVDS / DSI selection

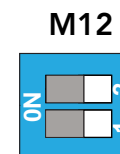

Table 21 Connector X23 Pinout Description

Pin	Signal	Pin	Signal
1	LVDS_DDC_DAT	18	LVDS0_D3+
2	LVDS_DDC_CLK	19	LVDS0_D3-
3	eDP0_HPD / DSI0_TE	20	GND
4	eDP1_HPD / DSI1_TE	21	LVDS1_D0-
5	GND	22	LVDS1_D0+
6	LVDS0_D0-	23	GND
7	LVDS0_D0+	24	LVDS1_D1-
8	LCD0_VDD_EN	25	LVDS1_D1+
9	LVDS0_D1-	26	GND
10	LVDS0_D1+	27	LVDS1_D2-
11	LCD0_BKLTEN	28	LVDS1_D2+
12	LVDS0_D2+	29	GND
13	LVDS0_D2-	30	LVDS1_CLK+
14	NC	31	LVDS1_CLK
15	LVDS0_CLK-	32	NC
16	LVDS0_CLK+	33	LVDS1_D3+
17	NC	34	LVDS1_D3-

LVDS Connector - X23





Connector Type

X23: 2 mm, 2 x 17 pin header

4.2.4.3 Flat Panel and Backlight Power Supply

The conga-SEVAL provides the following power supply connectors for panels and backlight inverters:

- connector X26 for LVDS panel connected to X23 or eDP panel connected to X31
- connector X30 for eDP panel connected to X32

Table 22 Connector X26 / X30 Pinout Description

Pin	Signal	Pin	Signal
1	VDD_LCD (2.0 A fuse)	2	VDD_BKLT (1.5 A fuse)
3	+5V (2.0 A fuse)	4	+12V (1.5 A fuse)
5	LCD_[0:1]_VDD_EN	6	LCD[0:1]_BKLT_EN
7	N.C	8	LCD[0:1]_BKLT_PWM
9	GND	10	GND

Panel & Bklt Power - X26 / X30

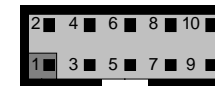

Connector Type

X26, X30: 2.54 mm, 2 x 5 pin female

4.2.4.4 Flat Panel and Backlight Voltage Selection

The conga-SEVAL supports different voltages for the panel and backlight. Follow the description below to set the panel and backlight voltages:

- For panels attached to connector X23 or X31, use:
 - jumper X22 to set the panel voltage to 3.3 V or 5 V
 - jumper X25 to set the backlight voltage to 5 V or 12 V
 - jumper X24 to change the polarity of backlight enable signal
- For panels attached to connector X32, use:
 - jumper X27 to set the panel voltage to 3.3 V or 5 V
 - jumper X28 to set the backlight voltage to 5 V or 12 V
 - jumper X29 to change the polarity of backlight enable signal



Table 23 Jumper X22 / X27 Pinout Description

Pin	Configuration
1-2	3.3 V panel power
2-3	5 V panel power

Jumper X22 / X27

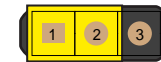

Table 24 Jumper X25 / X28 Pinout Description

Pin	Configuration
1-2	12 V backlight Power
2-3	5 V backlight Power

Jumper X25 / X28

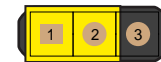
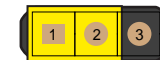

Table 25 Jumper X24 / X29 Pinout Description

Pin	Configuration
1-2	Disable backlight control
2-3	Enable backlight control

Jumper X24 / X29



Connector Type

X22, X24, X25, X27, X28, X29: 2.54 mm grid jumper



4.3 MIPI-CSI

The conga-SEVAL features a MIPI-CSI 2/3 flat foil connector (X13). The connector supports up to two camera interfaces—CSI0 and CSI1:

- CSI0 supports up to two differential data lanes
- CSI1 supports up to four differential data lanes

Table 26 Connector X13 Pinout Description

Pin	Signal	Pin	Signal
1	+V3.3S	19	CSI1_I2C_DAT
2	+V3.3S	20	GPIO1/CAM1_PWR#
3	CSI1_RX0+	21	CSI01_MCLK
4	CSI1_RX0-	22	GPIO0/CAM0_PWR#
5	GND	23	CSI0_I2C_CLK
6	CSI1_RX1+	24	CSI0_I2C_DAT
7	CSI1_RX1-	25	GND
8	GND	26	CSI0_CLK+
9	CSI1_RX2+	27	CSI0_CLK-
10	CSI1_RX2-	28	GND
11	GPIO3/CAM1_RST#	29	CSI0_RX0+
12	CSI1_RX3+	30	CSI0_RX0-
13	CSI1_RX3-	31	GPIO2/CAM0_RST#
14	GND	32	CSI0_RX1+
15	CSI1_CLK+	33	CSI0_RX1-
16	CSI1_CLK-	34	GND
17	GND	35	NC
18	CSI1_I2C_CLK	36	NC

MIPI - Connector X13

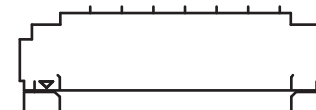

Connector Type

X13: 0.5 mm pitch, 36-pin flat foil connector



4.4 Universal Serial Bus (USB)

The conga-SEVAL provides the following USB connectors:

- Micro USB Type-AB
- Stacked Dual USB Type-A
 - USB 2.0 (lower port)
 - USB 3.0 (upper port)
- USB Type-C

The USB signals are also routed to M.2 and mPCIe interfaces as shown below:

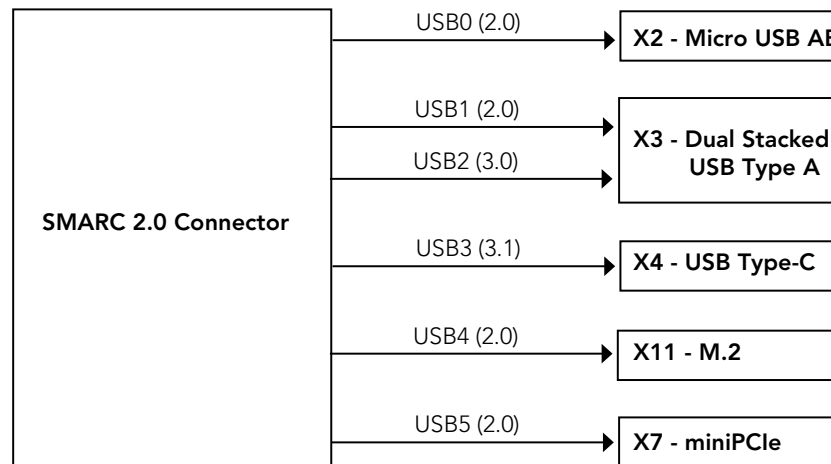

4.4.1 Micro USB Type-AB (OTG)

The conga-SEVAL features a micro USB Type-AB port with OTG capability on connector X2.

USB0 (OTG) - X2

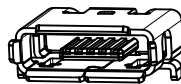

Connector Type



X2: Micro USB Type-AB receptacle



4.4.2 Dual Stacked USB Type-A

The conga-SEVAL provides a USB 3.0 port (upper slot) and a USB 2.0 port (lower slot) on connector X3. Each port provides up to 900 mA.

Dual USB Type - X3

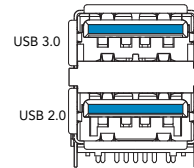

Connector Type

X3: *USB Type A receptacle*

4.4.3 USB Type-C

The conga-SEVAL features a USB Type-C port on connector X4. The port supports:

- USB 3.1 specification
- USB OTG
- DisplayPort
- Power Delivery (5 V, 12 V and 20 V)

USB Type-C - X4

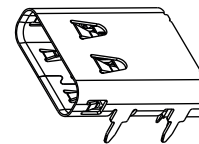

Connector Type

X4: *USB Type-C Receptacle*



4.5 SATA

The conga-SEVAL provides a standard SATA connector (X50). The SATA activity LED (D50) glows when an activity occurs on this interface.

Table 27 Connector X50 Description

Pin	Signal
1	GND
2	SATA_TX+
3	SATA_TX-
4	GND
5	SATA_RX
6	SATA_RX+
7	GND
8	GND
9	GND

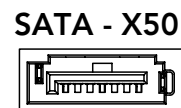

D50



Connector Type

X50: Standard SATA connector

4.6 HDD Power Connector

The conga-SEVAL provides connector X58 for powering hard disks. Use this connector when operating in non-ATX mode.

Table 28 Connector X58 Description

Pin	Signal
1	+12 V (1.5 A Fuse)
2	GND
3	GND
4	+5 V (2.0 A Fuse)

HDD Power - X58

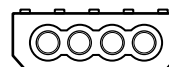

Connector Type

X58: 5.08 mm, 4-pin female connector



4.7 Gigabit Ethernet (GbE)

The conga-SEVAL provides two GbE connectors with magnetics (X12 and X15). The software definable pins for the GbE interfaces are connected to pin header X14. These pins may be used to synchronize all clocks within a network (via PTP) or for hardware or software-control purposes.

Use jumper X16 to select the power-source for the GbE status LEDs.

Table 29 Connector X14 Pinout Description

Pin	Signal
1	+V3.3_GBE
2	GBE0_SDP (for X12)
3	GBE1_SDP (for X15)
4	GND

GbE0/1 SDP - X14



GbE0/1 - X12, X15

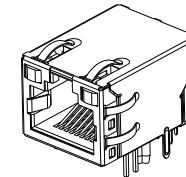

Table 30 Jumper X16 Description

Pin	Configuration
1-2	Status LEDs are powered by standby voltage
2-3	Status LEDs are powered by runtime voltage

Jumper X16



Connector Type

X12, X15: RJ45 with Gigabit Magnetic and LEDs (TYCO 2250015)

X14: 2.54 mm, 1 x 4-pin header

X16: 2.54 mm grid jumper



4.8 Audio Interfaces

The conga-SEVAL features two audio codecs—HDA (Cirrus Logic CS4207) and I²S (Cirrus Logic WM8904) codecs. The codecs support:

- MIC-IN signals on connector X19
- Line-OUT signals on connector X21
- S/PDIF signals on connector X20 (only HDA codec supports S/PDIF)

Use switch 1 of DIP switch M12 to select I²S or HDA codec.

Table 31 I²S or HDA Codec Selection

DIP Switch M12		Configuration
SW 1	SW 2	
OFF	N.A	I ² S codec
ON	N.A	HDA codec

4.8.1 MIC-IN

The conga-SEVAL provides MIC-IN signals on connector X19.

Table 32 MIC-IN (Connector X19) Pinout Description

Pin	Jack	Signal	Description
1	Tip	MIC_L	Microphone - left channel
2	Ring	MIC_R	Microphone - right channel
3	Sleeve	A_GND	Analog ground

Connector Type

X19: 3-pin, 3.5 mm single audio jack

MIC IN - X19



Jack (MIC-IN)

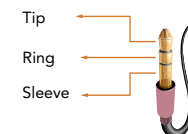



4.8.2 Line-OUT

Table 33 Line_OUT (Connector X21) Pinout Description

Pin	Jack	Signal	Description
1	Tip	LINE_L	Line-OUT - left channel
2	Ring	LINE_R	Line-OUT - right channel
3	Sleeve	A_GND	Analog ground

Connector Type

X21: 3-pin, 3.5 mm single audio jack

Line OUT - X21



Jack (Line-IN)

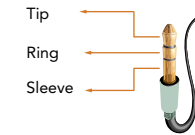

4.8.3 S/PDIF OUT

The conga-SEVAL provides S/PDIF-OUT signals on connector X20.

Table 34 SPDIF-OUT (Connector X20) Pinout Description

Pin	Signal
A	GND
B	+V3.3S
C	HDA_SPDIFO
S1	NC
S2	NC

Connector Type

X20: TOSLINK optical audio output (JIS F05)

S/PDIF OUT - X20





4.9 I2S Bus

The conga-SEVAL provides two I2S buses—I2S0 for M.2 devices (connector X11) and I2S2, which is multiplexed with HDA signals for digital audio interfaces. See section 4.8 “Audio Interfaces” for more information.

4.10 CAN Bus

The conga-SEVAL provides two CAN buses—CAN 0 on connector X46 and CAN 1 on connector X48. Use jumper X47 and X49 to enable or disable CAN 0 and CAN 1 termination respectively.

Table 35 Connector X46 Description

X46 - CAN 0		X48 - CAN 1	
Pin	Signal	Pin	Signal
1	CAN0_H	1	CAN1_H
2	CAN0_L	2	CAN1_L
3	GND	3	GND
4	NC	4	NC
5	NC	5	NC

CAN 0/1 - X46/X48

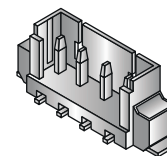

Table 36 Jumper X47/X49 Description

Pin	Configuration
1-2	Enable 120 Ω resistor termination
2-3	Disable 120 Ω resistor termination (default)

Jumper X47



Jumper X49



Connector Type

X46,X48: 3 x 1-pin header, PicoBlade, 1MM25, SMT

X47, X49: 2.54 mm grid jumper



4.11 I2C Bus

The conga-SEVAL provides two I2C interfaces— general purpose interface and power management interface.

4.11.1 General Purpose I2C

The general purpose I²C signals are available in different locations on the conga-SEVAL, including on the feature connector X37. The conga-SEVAL includes socket P20 for an I²C EEPROM (U40) for test purposes during the system development. This 8-pin DIL socket can be used with various 2-wire serial EEPROMS (for example 24C04 / 24C08 / 24C16 / 24C32) and can be accessed by using the I²C control commands implemented in the congatec CGOS API driver.

Use DIP switch SW1 to configure the EEPROM's address inputs (A0-A2) and write protect (WP) pin. Switches 1, 2 and 3 of DIP SW1 are set to OFF (high state) by default while switch 4 is set to ON (low state) by default. This default configuration sets address pins A0, A1 and A2 to high and the WP pin to low.

Table 37 DIP Switch SW1 Description

SW1 - DIP				Address Configuration
Switch 1	Switch 2	Switch 3	Switch 4	
ON	OFF	OFF	OFF	A0
OFF	ON	OFF	OFF	A1
OFF	OFF	ON	OFF	A2
N.A	N.A	N.A	ON	WP

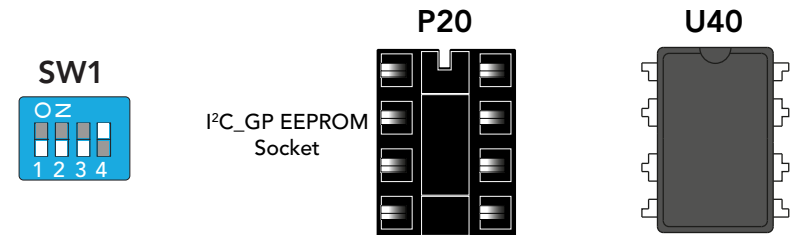

Connector Type

P20: 8-pin DIL socket

U40: 8-pin I²C EEPROM



4.11.2 Power Management I2C

The power management I²C signals are available in different locations on the conga-SEVAL. The conga-SEVAL includes socket P21 for an I²C EEPROM (U42). The EEPROM is connected to the power management bus, in the module's power domain. This connection enables the module to obtain carrier board parameters from the EEPROM, before asserting the CARRIER_PWR_ON signal.

The conga-SEVAL features an Atmel 24C32 EEPROM on the 8-pin DIL socket (P21). The address inputs (A0 - A2) of the EEPROM are set to binary 111.

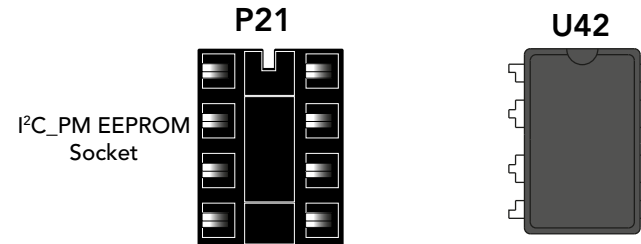

Connector Type

P21: 8-pin DIL socket

U42: 8-pin I²C EEPROM

4.12 eSPI / SPI1

The conga-SEVAL provides eSPI / SPI signals on connector CN2 for eSPI add-on modules.

Table 38 Connector CN2 Description

Pin	Signal	Pin	Signal
1	GND	2	ESPI_CS0#
3	ESPI_CLK_R	4	ESPI_IO3
5	Empty	6	ESPI_IO2
7	ESPI_RST#	8	ESPI_IO1
9	+V3.3S	10	ESPI_IO0
11	ESPI_ALERT1#	12	ESPI_CS1#
13	+V3.3A	14	ESPI_ALERT0#

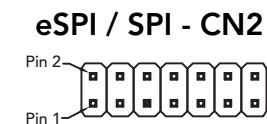



Connector Type

CN2: 2.54 mm, 2 x 7 pin header

4.12.1 SPI

The conga-SEVAL offers the possibility to boot the SMARC module from an onboard SPI flash via an 8-pin SOIC socket (U37) or from an SPI device attached to connector X39. The SPI flash onboard the conga-SEVAL makes it possible to evaluate a customized BIOS.

Use switch 2 of DIP switch M18 to start or stop SPI communication (SPI_HOLD#) with the SPI flash onboard the conga-SEVAL (U37), and DIP switch M17 and M18 to configure which flash device the SMARC module should boot from. For more information about boot selection, see section 4.13 "Boot Selection".

Table 39 DIP Switch M18 Pinout Description

DIP Switch M18		Configuration
SW 1	SW 2	
N.A	OFF	Start SPI communication
N.A	ON	Stop SPI communication (pauses the EEPROM)

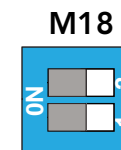

SOIC Socket - U37

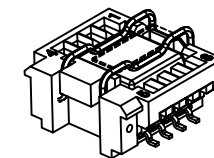

Table 40 Connector X39 Pinout Description

Pin	Signal	Pin	Signal
1	+V1.8_SPI	6	SPI0_CS1#
2	GPIO7	7	SPI0_CLK_HDR
3	SPI0_DOUT_HDR	8	RESET_OUT#
4	SPI0_CS0#_HDR	9	GND
5	SPI0_DIN_HDR	10	GND

SPI Header - X39



Connector Type

X39: 2.54 mm, 2x5 pin female



4.13 Boot Selection

Use DIP switch M17 and M18 to select the boot source as shown in the table below. The LEDs D42 - D49 indicate the selected boot source.

Table 41 DIP Switch M17 / M18 Description

DIP M18		DIP M17		Boot Source
M18.2	M18.1	M17.2	M17.1	
OFF	ON	ON	ON	Carrier SATA
OFF	ON	ON	OFF	Carrier SDIO
OFF	ON	OFF	ON	Carrier eSPI
OFF	ON	OFF	OFF	Carrier SPI
OFF	OFF	ON	ON	Module device
OFF	OFF	ON	OFF	Remote boot
OFF	OFF	OFF	ON	Module eMMC
OFF	OFF	OFF	OFF	Module SPI

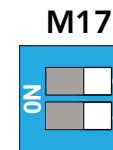
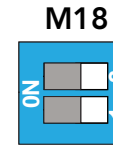

- D42 SATA
- D43 SDIO
- D44 eSPI
- D45 Carrier SPI
- D46 Module NOR
- D47 Remote
- D48 eMMC
- D49 Module SPI



Note
Setting Switch 2 of DIP switch M18 (HOLD# signal) to ON pauses the boot device.

4.14 Force Recovery

Use jumper X45 to operate the SMARC module in force recovery mode. For more information about this mode, refer to the module's manual.

Table 42 Jumper X45 Description

Pin	Configuration
1-2	Normal operation (default)
2-3	Force recovery mode

Jumper X45

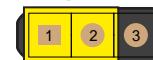

Connector Type

X45: 2.54 mm grid jumper



4.15 SIM Card Slot

The conga-SEVAL features a SIM card slot on connector X8. The slot is connected to the UIM interface of the mPCIe slot.

Table 43 Connector X8 Pinout Description

Pin	Signal	Description
1	UIM_PWR	Power
2	UIM_RST	Reset
3	UIM_CLK	Clock
4	GND	Ground
5	UIM_VPP	Programming voltage input
6	UIM_DAT	Data

SIM Card Slot - X8

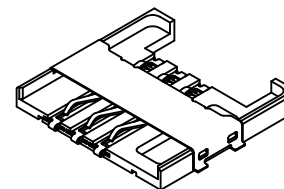

Connector Type

X8: SIM Card socket (Molex 47308-0001)

4.16 SD Card Slot

The conga-SEVAL features a full-size SD card slot on connector CN1.

Note

1. Because the SDIO signals are shared between CN1 and X11 (M.2) via a multiplexer, some high-speed micro-SD cards enclosed in an SD card adapter may not function.
2. SDIO-based cards will not function on M.2 connector if an SD card is inserted into connector CN1.

Table 44 Connector CN1 Pinout Description

Pin	Signal	Pin	Signal
1	SDIO_WP	9	+V3.3S_SDIO
2	SDIO_CD#	10	GND
3	SDIO_D1	11	N.C
4	SDIO_D0	12	SDIO_CMD

SD Card Slot - CN1

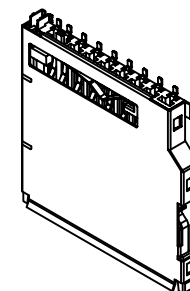



5	N.C	13	N.C
6	GND	14	SDIO_D3
7	N.C	15	SDIO_D2
8	SDIO_CLK		

Connector Type

CN1: SD Card Socket

4.17 Serial Ports

The conga-SEVAL supports up to four serial ports:

- COM port 0 on DSub9 connector X18
- COM port 1 on pin header X17
- COM port 2 on feature connector X37 (COM signals are shared with M.2 connector)
- COM port 3 on feature connector X37

4.17.1 COM Port 0

COM port 0 supports RS 232 I/O voltage levels.

Table 45 Connector X18 Pinout Description

Pin	Signal	Pin	Signal
1	NC	6	NC
2	SER0_RXD	7	SER0_RTS
3	SER0_TXD	8	SER0_CTS
4	NC	9	NC
5	SER0_GND		

Connector Type

X18: 9-pin D-Sub connector

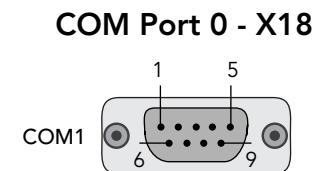



4.17.2 COM Port 1

COM port 1 supports RS 232 I/O voltage levels.

Table 46 Connector X17 Pinout Description

Pin	Signal	Pin	Signal
1	N.C	2	N.C
3	SER1_RXD	4	N.C
5	SER1_TXD	6	N.C
7	N.C	6	N.C
9	SER1_GND	10	N.C

COM Port 1 - X17



Connector Type

X17: 2.54 mm, 2 x 5 pin header

4.17.3 COM Port 2

COM port 2 signals are connected to pins 41- 44 of the feature connector. These signals are shared with M.2 connector, via a multiplexer. The conga-SEVAL routes COM port 2 signals to the M.2 connector if an M.2 card is detected.

COM port 2 supports I/O voltage levels of 1.8 V. See section 5.3 “Feature Connector” for the pinout description.

4.17.4 COM Port 3

COM port 3 signals (TX and RX) are connected directly to pins 9 and 11 of the feature connector. These pins support I/O voltage levels of 1.8 V. See section 5.3 “Feature Connector” for the pinout description.



4.18 FAN

The conga-SEVAL provides a 4-pin fan connector (X42). The fan's PWM control and tachometer pins are multiplexed with GPIO5 and GPIO6 respectively.

Use jumper X43 to set the supply voltage of the attached cooling fan to 5 V or 12 V.

Table 47 Connector X42 Pinout Description

Pin	Signal
1	GND
2	FAN_PWR (12 V or 5 V)
3	FAN_TACHO
4	FAN_PWM

FAN - X42

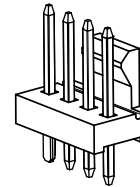

Table 48 Jumper X43 Description

Pin	Configuration
1-2	12V
2-3	5V

Jumper X43



Connector Type

X42: 4-pin vertical fan connector

X43: 2.54 mm grid jumper



5 Additional Features

5.1 Buttons

The conga-SEVAL features four different buttons. These are power, reset, LID and sleep buttons.

5.1.1 Power

When using an ATX power supply, the SMARC® module starts after the power-on button M19 is pressed.

Pwr On - M19

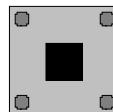

5.1.2 Reset

The SMARC® module and all connected components will perform a hard reset when this button is pressed. The reset button is connected to the SMARC® module's RESET_IN# signal.

Reset - M20

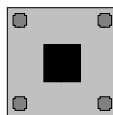

5.1.3 LID

You can trigger the LID# signal by pressing the lid button M21. The system's behaviour depends on the ACPI settings of the Operating System.

Lid - M21

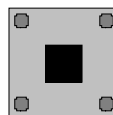



5.1.4 Sleep

You can trigger the SLEEP# signals by pressing the sleep button M22. The system's behaviour depends on the ACPI settings of the Operating System.

Sleep - M22

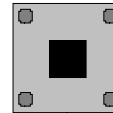

5.2 Ground Test Points

The conga-SEVAL provides six test points that are connected to Ground Potential (M1 - M5 and M39). These test points make it easier to connect oscilloscope probes and multimeter lines to ground when performing measurements on the S(MARC®) module.

Test Points - (M1 - M5, M39)

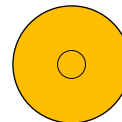

5.3 Feature Connector

Table 49 Connector X37 Description

Pin	Signal	Description	Pin	Signal	Description
1	+5V (750 mA fuse)		2	5V_SB (750 mA fuse)	
3	+5V	330 Ω series resistor	4	Hard Disk Activity	Shows activity on hard disk interface
5	GP_I2C_DAT_3V3	General purpose I ² C port data I/O line	6	PM_I2C_CLK_3V3	Power management I ² C port clock
7	GP_I2C_CLK_3V3	General purpose I ² C port clock output	8	PM_I2C_DAT_3V3	Power management I ² C data I/O line
9	SER3_Tx	COM port 3 transmit signal	10	GPIO4_3V3	General purpose input/output port 4
11	SER3_RX	COM port 3 receive signal	12	GPIO5_3V3	General purpose input/output port 5
13	PS_ON#	Power supply on (active low)	14	GPIO6_3V3	General purpose input/output port 6
15	CARRIER_STBY#_3V3	Indicates the system is in Suspend to RAM state	16	GPIO7_3V3	General purpose input/output port 7
17	GND	Power ground	18	GND	Power ground



19	N.C	Not connected	20	SMBALERT#	System Management Bus Alert – can be used to generate a system management interrupt or to wake the system.
21	GPIO9_3V3	General purpose input/output port 9	22	CARRIER_PWRON_3V3	Ensures the module is powered before carrier board main power.
23	N.C	Not connected	24	GPIO8_3V3	General purpose input/output port 8
25	GPIO10_3V3	General purpose input/output port 10	26	CARRIER_PWRON_3V3	Ensures the module is powered before carrier board main power.
27	WDT_OUT#		28	N.C	Not connected
29	GPIO11_3V3	General purpose input/output port 11	30	LID#	Module input signal, generation a LID close or open event
31	BATLOW#	Indicates that external battery is low	32	N.C	Not connected
33	N.C	Not connected	34	N.C	Not connected
35	SLEEP#	Brings the system to a predefined sleep state	36	RESET_IN#	Reset button input.
37	GND	Power ground	38	GND	Power ground
39	PWBTN#	Power button, active on rising edge	40	VIN_PWRBAD#	Power bad indication from carrier board. High indicates that the power is good.
41	SER2_TX	Serial port 2 transmit line	42	SER2_RTS	Serial port 2 request to send
43	SER2_RX	Serial port 2 receive line	44	SER2_CTS	Serial port 2 clear to send

Feature Connector X37



Connector Type

X37: 2.54 mm, 2 x 22 pin header



5.4 Debug Display Port

The conga-SEVAL provides four seven-segment displays for post code or debug information. The displays are connected to the general purpose I2C bus. The default I2C address of the debug display is 0xE2.

Table 50 Jumper X56 Description

Pin	Configuration
1-2	Enable postcode (default)
2-3	Disable postcode

Jumper X56



Debug Display

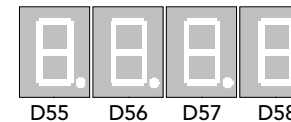

Connector Type

X56: 2.54 mm grid jumper

5.5 GPIO

The conga-SEVAL provides 12 GPIOs (GPIO [0:11]). The GPIOs are available in different locations on the conga-SEVAL as shown in the table below.

Use jumper X40 to enable or disable GPIO[0:7] pins.

Table 51 GPIO Alternate Function and Routing

Signal	Alternate Function	Routed To
GPIO0	CAM0_PWR#	GPIO connector X38, JTAG connector X62 or MIPI connector X13
GPIO1	CAM1_PWR#	GPIO connector X38, JTAG connector X62 or MIPI connector X13
GPIO2	CAM0_RST#	GPIO connector X38, JTAG connector X62 or MIPI connector X13
GPIO3	CAM1_RST#	GPIO connector X38, JTAG connector X62 or MIPI connector X13
GPIO4	HDA_RST#	Audio connector or feature connector X37
GPIO5	PWM_OUT	Fan connector X42 or feature connector X37
GPIO6	TACHIN	Fan connector X42 or feature connector X37
GPIO[7:11]	N.A	Feature connector X37



Table 52 Jumper X40 Description

Pin	Configuration
1-2	Enable GPIO [0:7] (default)
2-3	Disable GPIO [0:7]

Jumper X40

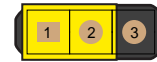

Table 53 GPIO Connector X38 Description

Pin	Signal
1	GPIO0
2	GPIO1
3	GPIO2
4	GPIO3
5	GND

GPIO [0:3] - X38



Connector Type

X38: 2.54 mm, 1 x 5 pin header

X40: 2.54 mm grid jumper

5.6 JTAG (Debug Feature) - Internal Use Only

The conga-SEVAL provides a JTAG interface on connector X62. This interface is used for programming and debugging the congatec board controller.

Set jumper X44 to position 1-2 for normal operation.

Table 54 Jumper X44 Description

Pin	Configuration
1-2	Normal Operation (default)
2-3	Test Mode

Jumper X44

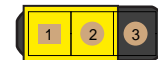



Table 55 Connector X62 Description

Pin	Signal
1	+V3.3
2	TDO
3	TDI
4	TCK
5	TMS
6	TEST#_EN (jumper X44)
7	GND



 **Connector Type**

X62: 2.54 mm, 1x7 pin header

X44: 2.54 mm grid jumper

5.7 Module Detection - Internal Use Only

The conga-SEVAL provides jumper X64 for detecting the presence of a SMARC module. This jumper is for internal use only.

5.8 Optional HDMI Recording

The conga-SEVAL provides optional jumper X65 for HDMI recording. With jumper X65, the hot plug detect signal is pulled high.

Table 56 Jumper X65 Description

Pin	Configuration
1-2	Not connected (default)
2-3	Recording device

 **Note**

The SMARC module must also support this feature for it to function.



6 Mechanical Dimensions

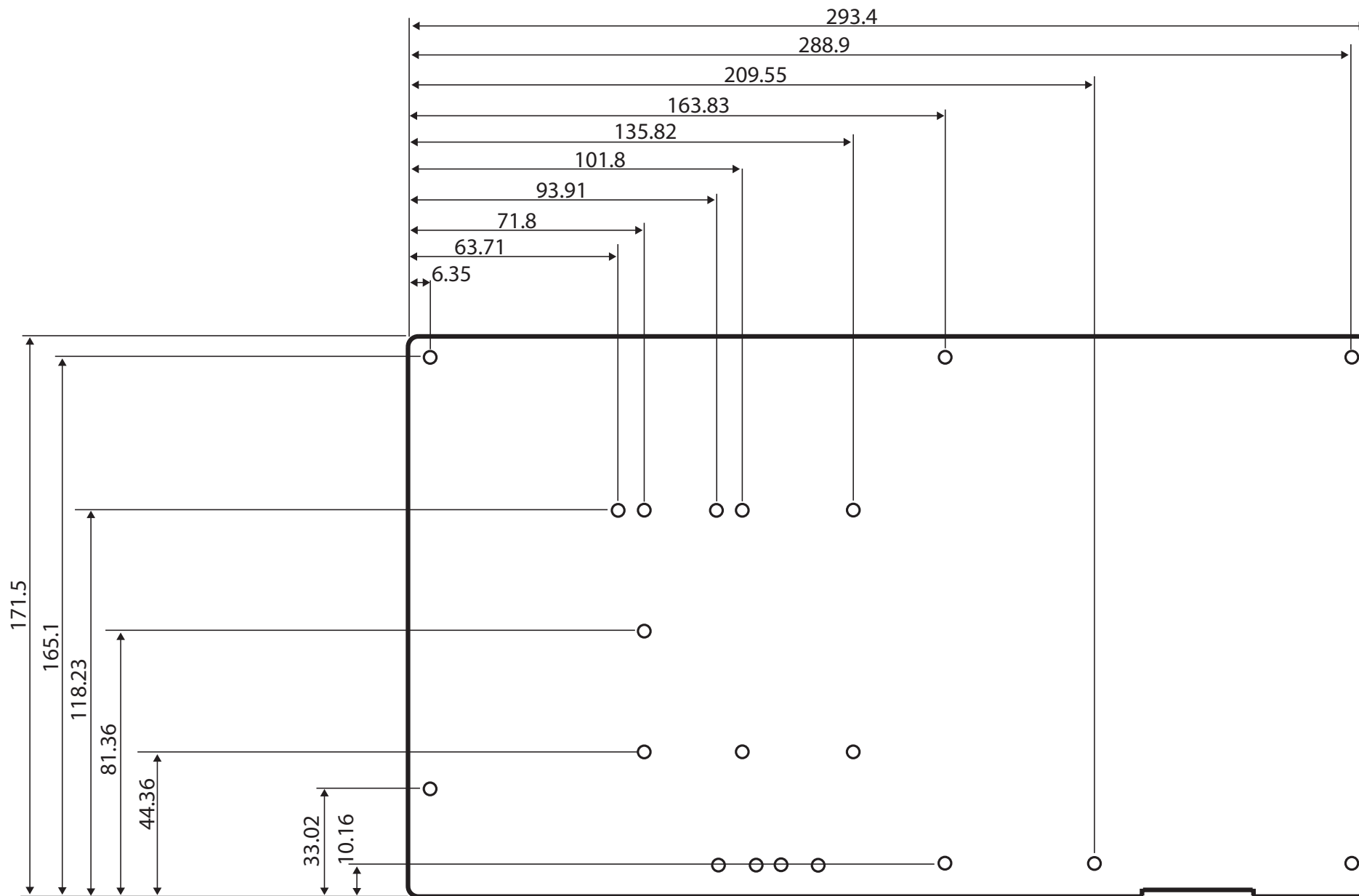

Our company network supports you worldwide with offices in Germany, Austria, Switzerland, the UK and the USA. For more information please contact:

Headquarters

Germany



FORTEC Elektronik AG

Augsburger Str. 2b
82110 Germering

Phone: +49 89 894450-0
E-Mail: info@fortecaq.de
Internet: www.fortecaq.de

Fortec Group Members

Austria



**Distec GmbH,
Office Vienna**

Nuschinggasse 12
1230 Wien

Phone: +43 1 8673492-0
E-Mail: info@distec.de
Internet: www.distec.de

Germany



Distec GmbH

Augsburger Str. 2b
82110 Germering

Phone: +49 89 894363-0
E-Mail: info@distec.de
Internet: www.distec.de

Switzerland



ALTRAC AG

Bahnhofstraße 3
5436 Würenlos

Phone: +41 44 7446111
E-Mail: info@altrac.ch
Internet: www.altrac.ch

United Kingdom



Display Technology Ltd.

Osprey House, 1 Osprey Court
Hinchingsbrooke Business Park
Huntingdon, Cambridgeshire, PE29 6FN

Phone: +44 1480 411600
E-Mail: info@displaytechnology.co.uk
Internet: www.displaytechnology.co.uk

USA



Apollo Display Technologies, Corp.

87 Raynor Avenue,
Unit 1 Ronkonkoma,
NY 11779

Phone: +1 631 5804360
E-Mail: info@apolloDisplays.com
Internet: www.apolloDisplays.com