



OUR GLOBAL
COMPETENCE
CENTRES

 APOLLO DISPLAY
TECHNOLOGIES



 DISTEC



 DISPLAY
TECHNOLOGY



Manual

congatec

conga-IC175

Mini-ITX Embedded Motherboard with 7. Gen. Intel® Core and Celeron U Processors

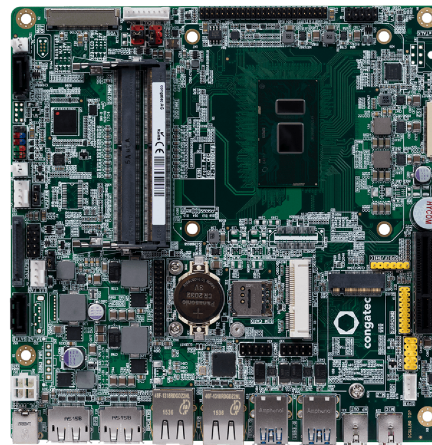

The information contained in this document has been carefully researched and is, to the best of our knowledge, accurate. However, we assume no liability for any product failures or damages, immediate or consequential, resulting from the use of the information provided herein. Our products are not intended for use in systems in which failures of product could result in personal injury. All trademarks mentioned herein are property of their respective owners. All specifications are subject to change without notice.

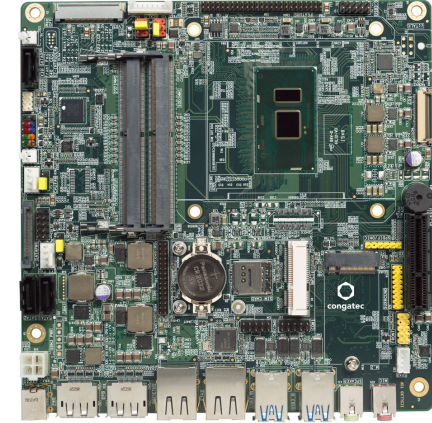

conga-IC175 Thin Mini-ITX SBC

Detailed Description Of The congatec Thin Mini-ITX Based On 7th Generation Intel U-Series SoC

User's Guide

Revision 1.1

Revision History

Revision	Date (yyyy-mm-dd)	Author	Changes
0.1	2017-01-18	AEM	<ul style="list-style-type: none">• Preliminary release
0.2	2017-12-05	AEM	<ul style="list-style-type: none">• Updated section 5.8.1 "Standard SATA Connectors"• Updated table 43 "Feature Connector X38 Pinout Description"• Added content to section 8 "BIOS Setup Description"
1.0	2018-08-01	AEM	<ul style="list-style-type: none">• Updated tables 10 "Power Consumption Values" and 11 "CMOS Battery Power Consumption" in section 2.5• Deleted references to MIPI interface because the conga-IC175 does not support it• Added note about Wake on LAN from S5 mode in section 5.7 "Ethernet"• Re-structured the sections• Official release
1.1	2020-06-15	AEM	<ul style="list-style-type: none">• Updated section 1.2.2 "Optional Accessories"• Updated the statement about electrostatic sensitive devices in the preface section• Corrected power consumption values for PN:052901• Updated section 4 "Cooling Solution"• Added section 8.4 "Supported Flash Devices"• Deleted section 9 "Industry Specifications"

Preface

This user's guide provides information about the components, features and connectors available on the conga-IC175 Thin Mini-ITX single board.

Disclaimer

The information contained within this user's guide, including but not limited to any product specification, is subject to change without notice.

congatec AG provides no warranty with regard to this user's guide or any other information contained herein and hereby expressly disclaims any implied warranties of merchantability or fitness for any particular purpose with regard to any of the foregoing. congatec AG assumes no liability for any damages incurred directly or indirectly from any technical or typographical errors or omissions contained herein or for discrepancies between the product and the user's guide. In no event shall congatec AG be liable for any incidental, consequential, special, or exemplary damages, whether based on tort, contract or otherwise, arising out of or in connection with this user's guide or any other information contained herein or the use thereof.

Intended Audience

This user's guide is intended for technically qualified personnel. It is not intended for general audiences.

Lead-Free Designs (RoHS)

All congatec AG products are created from lead-free components and are completely RoHS compliant.

Electrostatic Sensitive Device



All congatec AG products are electrostatic sensitive devices. They are enclosed in static shielding bags, and shipped enclosed in secondary packaging (protective packaging). The secondary packaging does not provide electrostatic protection.

Do not remove the device from the static shielding bag or handle it, except at an electrostatic-free workstation. Also, do not ship or store electronic devices near strong electrostatic, electromagnetic, magnetic, or radioactive fields unless the device is contained within its original packaging. Be aware that failure to comply with these guidelines will void the congatec AG Limited Warranty.

Symbols

The following symbols are used in this user's guide:



Warning

Warnings indicate conditions that, if not observed, can cause personal injury.



Caution

Cautions warn the user about how to prevent damage to hardware or loss of data.



Note

Notes call attention to important information that should be observed.



Connector Type

Describes the connector used on the Single Board Computer.

Copyright Notice

Copyright © 2017, congatec AG. All rights reserved. All text, pictures and graphics are protected by copyrights. No copying is permitted without written permission from congatec AG.

congatec AG has made every attempt to ensure that the information in this document is accurate yet the information contained within is supplied "as-is".

Trademarks

Product names, logos, brands, and other trademarks featured or referred to within this user's guide, or the congatec website, are the property of their respective trademark holders. These trademark holders are not affiliated with congatec AG, our products, or our website.

Warranty

congatec AG makes no representation, warranty or guaranty, express or implied regarding the products except its standard form of limited warranty ("Limited Warranty") per the terms and conditions of the congatec entity, which the product is delivered from. These terms and conditions can be downloaded from www.congatec.com. congatec AG may in its sole discretion modify its Limited Warranty at any time and from time to time.

The products may include software. Use of the software is subject to the terms and conditions set out in the respective owner's license agreements, which are available at www.congatec.com and/or upon request.

Beginning on the date of shipment to its direct customer and continuing for the published warranty period, congatec AG represents that the products are new and warrants that each product failing to function properly under normal use, due to a defect in materials or workmanship or due to non conformance to the agreed upon specifications, will be repaired or exchanged, at congatec's option and expense.

Customer will obtain a Return Material Authorization ("RMA") number from congatec AG prior to returning the non conforming product freight prepaid. congatec AG will pay for transporting the repaired or exchanged product to the customer.

Repaired, replaced or exchanged product will be warranted for the repair warranty period in effect as of the date the repaired, exchanged or replaced product is shipped by congatec, or the remainder of the original warranty, whichever is longer. This Limited Warranty extends to congatec's direct customer only and is not assignable or transferable.

Except as set forth in writing in the Limited Warranty, congatec makes no performance representations, warranties, or guarantees, either express or implied, oral or written, with respect to the products, including without limitation any implied warranty (a) of merchantability, (b) of fitness for a particular purpose, or (c) arising from course of performance, course of dealing, or usage of trade.

congatec AG shall in no event be liable to the end user for collateral or consequential damages of any kind. congatec shall not otherwise be liable for loss, damage or expense directly or indirectly arising from the use of the product or from any other cause. The sole and exclusive remedy against congatec, whether a claim sound in contract, warranty, tort or any other legal theory, shall be repair or replacement of the product only.

Certification



congatec AG is certified to DIN EN ISO 9001 standard.



Technical Support

congatec AG technicians and engineers are committed to providing the best possible technical support for our customers so that our products can be easily used and implemented. We request that you first visit our website at www.congatec.com for the latest documentation, utilities and drivers, which have been made available to assist you. If you still require assistance after visiting our website then contact our technical support department by email at support@congatec.com

Terminology

Term	Description
PCIe	Peripheral Component Interface Express
cBC	congatec Board Controller
SDIO	Secure Digital Input Output
USB	Universal Serial Bus
SATA	Serial AT Attachment
HDA	High Definition Audio
S/PDIF	Sony/Philips Digital Interconnect Format
HDMI	High Definition Multimedia Interface
TMDS	Transition Minimized Differential Signaling
DVI	Digital Visual Interface
LPC	Low Pin-Count
I ² C Bus	Inter-Integrated Circuit Bus
SM Bus	System Management Bus
SPI	Serial Peripheral Interface
GbE	Gigabit Ethernet
LVDS	Low-Voltage Differential Signaling
DDC	Display Data Channel
PN	Part Number
N.C	Not connected
N.A	Not available
T.B.D	To be determined

Contents

1	Introduction	10	5.4.2	LVDS.....	30
1.1	Mini-ITX Concept.....	10	5.4.3	Embedded DisplayPort (eDP)	32
1.2	conga-IC175	10	5.4.3.1	Backlight Power Connector	33
1.2.1	Options Information.....	11	5.4.3.2	Backlight/Panel Power Selection	33
1.2.2	Optional Accessories	11	5.4.3.3	Monitor OFF connector	34
2	Specification	13	5.5	USB	34
2.1	Feature List	13	5.5.1	Rear USB Connectors.....	34
2.2	Supported Operating Systems	14	5.5.2	Internal USB Connectors.....	35
2.3	Mechanical Dimensions	14	5.6	SATA Interfaces.....	36
2.4	Supply Voltage Power.....	15	5.6.1	Standard SATA Ports.....	36
2.5	Power Consumption	15	5.6.2	SATA Power	37
2.6	Supply Voltage Battery Power	16	5.6.3	M.2 Slot.....	38
2.7	Environmental Specifications.....	17	5.7	Ethernet	40
3	Block Diagram.....	18	5.8	Audio Interface	40
4	Cooling Solution	19	5.8.1	Rear Audio Connectors.....	40
4.1	Active Cooling Dimensions.....	20	5.8.2	Internal Audio Connectors.....	41
4.2	Cooling Installation	21	5.8.2.1	Stereo Speaker Header.....	41
5	Connector Description.....	22	5.8.2.2	Digital Microphone/SPDIF.....	42
5.1	Power Supply	22	5.8.2.3	Front Panel (HD Audio/AC97).....	42
5.1.1	DC Power Jack (Rear I/O)	22	5.8.2.4	Surround header	43
5.1.2	Power Supply (Internal Connector)	23	5.9	SMBus	43
5.1.3	Optional SBM ³ Power Connector (Internal Connector)	23	5.10	SPI Bus	43
5.1.3.1	Optional SBM3 Signal Connector.....	24	5.11	I ² C Bus	44
5.1.4	Power Status LEDs	24	5.12	LPC Super I/O Device	44
5.2	CMOS Battery/RTC.....	25	5.12.1	GPIOs.....	44
5.3	PCI Express	26	5.12.2	Serial Ports (COM)	44
5.3.1	PCIe x4 Slot.....	26	5.12.3	CPU/System Fan Connector & Power Configuration.....	45
5.3.2	Full/half-size Mini PCIe	27	6	Additional Features.....	46
5.3.3	PCI Express Routing.....	29	6.1	Front Panel Connector.....	46
5.4	Display Interfaces.....	30	6.2	Micro-SIM Card.....	47
5.4.1	Display Port Interface DP++	30	6.3	Micro-SD Card	47
			6.4	Integrated Sensor Hub.....	48
			6.5	Case Open Intrusion Connector	49
			6.6	Optional TPM.....	49

6.7	congatec Board Controller (cBC)	49	6.11	External System Wake Event	52
6.7.1	Fan Control	49	6.12	Feature Connector	52
6.7.2	Power Loss Control	50	7	conga-IC175 Mechanical Drawing	54
6.7.3	Board Information	50	8	BIOS Setup Description	55
6.8	Embedded BIOS	50	8.1	Navigating the BIOS Setup Menu	55
6.8.1	OEM Default Settings and OEM BIOS Logo	50	8.2	BIOS Versions	55
6.8.2	OEM BIOS Code	50	8.3	Updating the BIOS	56
6.8.3	congatec Battery Management Interface	51	8.4	Supported Flash Devices	56
6.8.4	API Support (CGOS)	51			
6.9	Thermal/Voltage Monitoring	51			
6.10	Beeper	51			

List of Tables

Table 1	conga-IC175 Variants.....	11	Table 37	Connector X11 Pinout Description	47
Table 2	Cooling/IO Shield	11	Table 38	Connector X60 Pinout Description	47
Table 3	Cables	11	Table 39	ISH (Connector X61) Pinout Description.....	48
Table 4	Adapters	12	Table 40	Case Open Intrusion (Connector X2) Pinout Description	49
Table 5	Power Supply	12	Table 41	Feature Connector X38 Pinout Description	52
Table 6	Feature Summary	13			
Table 7	Measurement Description.....	15			
Table 8	Power Consumption Values	16			
Table 9	CMOS Battery Power Consumption	16			
Table 10	Cooling Solution Variants.....	19			
Table 11	Connector X48 Pinout Description	22			
Table 12	Connector X49 Pinout Description	23			
Table 13	Connector X47 Pinout Description	23			
Table 14	Connector X46 Pinout Description	24			
Table 15	LED States.....	24			
Table 16	PCIe x4 Slot (Connector X7) Pinout Description.....	26			
Table 17	mPCIe (Connector X8) Pinout Description.....	27			
Table 18	Connector X25 Pinout Description	31			
Table 19	Connector X20 Pinout Description	32			
Table 20	Connector X22 Pinout Description	33			
Table 21	Connector X23 Pinout Description	33			
Table 22	Connector X24 Pinout Description	34			
Table 23	Connector X21 Pinout Description	34			
Table 24	Connector X16 Pinout Description	35			
Table 25	Connector X15 Pinout Description	36			
Table 26	Connector X12 Pinout Description	37			
Table 27	Connector X10 Pinout Description (Revision B.x and later).....	38			
Table 28	LED Description	40			
Table 29	MIC-IN (Connector X29) Pinout Description.....	40			
Table 30	Line-OUT (Connector X31) Pinout Description.....	41			
Table 31	Stereo Speaker (Connector X30) Pinout Description	41			
Table 32	HDA/AC97 Front Panel (Connector X27) Pinout Description ..	42			
Table 33	Surround (Connector X26) Pinout Description.....	43			
Table 34	Serial Ports (Connectors X34/X37) Pinout Description	44			
Table 35	CPU/SYS Fan Pinout	45			
Table 36	Front Panel (Connector X39) Pinout Description	46			

1 Introduction

1.1 Mini-ITX Concept

The Mini-ITX form factor provides enthusiasts and manufacturers with a standardized ultra compact platform for development. With a footprint of 170 mm x 170 mm, this scalable platform promotes the design of highly integrated, energy efficient systems. Due to its small size, the Mini-ITX form factor enables PC appliance designers not only to design attractive low cost devices but also allows them to explore a huge variety of product development options - from compact space-saving designs to fully functional Information Station and Value PC systems. This helps to reduce product design cycle and encourages rapid innovation in system design, to meet the ever-changing needs of the market.

Additionally, the boards can also be passively cooled, presenting opportunities for fanless designs. The Mini-ITX boards are equipped with various interfaces such as PCI Express, SATA, USB 2.0/3.0, Ethernet, Displays and Audio.

1.2 conga-IC175

The conga-IC175 is a Single Board Computer designed based on the Thin Mini-ITX specification. The conga-IC175 SBC features the 7th Generation Intel Core U-Series processors. With 15W base TDP, the SBC offers Ultra Low Power boards with high computing performance and outstanding graphics. Additionally, the SBC supports dual channel DDR4 up to 2133 MT/s for a maximum system memory capacity of 32 GB, multiple I/O interfaces, up to three independent displays and various congatec embedded features.

With smaller board size and lower height keep-out zones, the conga-IC175 SBC provides manufacturers and system designers with the opportunity to design compact systems for space restricted areas. With appropriate I/O shield, the same conga-IC175 SBC can be used in either a Thin Mini-ITX or a Mini-ITX design.

The various features and capabilities offered by the conga-IC175 makes it ideal for the design of compact, energy efficient, performance-oriented embedded systems.

1.2.1 Options Information

The conga-IC175 is currently available in four variants. This user's guide describes all of these variants. The table below show the different configurations available. Check for the part number that applies to your product. This will tell you what options described in this user's guide are available on your particular module

Table 1 conga-IC175 Variants

Part-No.	052900	052901	052902	052903
Processor	Intel® Core™ i5-7300U 2.6 GHz Dual Core™	Intel® Core™ i3-7100U 2.4 GHz Dual Core™	Intel® Celeron® 3965U 2.2 GHz Dual Core	Intel® Core™ i7-7600U 2.8 GHz Dual Core™
Intel® Smart Cache	3 MB	3 MB	2 MB	4 MB
Max. Turbo Frequency	3.5 GHz	N.A	N.A	3.9 GHz
Processor Graphics	Intel® HD Graphics 620 (GT2)	Intel® HD Graphics 620 (GT2)	Intel® HD Graphics 610 (GT1)	Intel® HD Graphics 620 (GT2)
Graphics Max. Dynamic Freq	1.1 GHz	1.0 GHz	0.9 GHz	1.1 GHz
Memory (DDR4)	2133 MT/s dual channel	2133 MT/s dual channel	2133 MT/s dual channel	2133 MT/s dual channel
LVDS	Yes	Yes	Yes	Yes
DisplayPort (DP)	Yes	Yes	Yes	Yes
HDMI	Yes	Yes	Yes	Yes
Processor TDP (cTDP)	15 (7.5) W	15 (7.5) W	15 (10) W	15 (7.5) W

1.2.2 Optional Accessories

Table 2 Cooling/IO Shield

Accessories	Part No.	Description
conga-IC87/CSA	052252	Active cooling solution for conga-IC87/IC97/IC170/IC175 and with 12 V fan and Thin Mini-ITX height
conga-IC87/Retention Frame	052254	Retention frame for standard cooling (PN: 052252) for conga-IC87/IC97/IC170/IC175
conga-IC170 IO Shield - Standard Size	052751	IO shield with standard Mini-ITX height for conga-IC175
conga-IC170 IO Shield - Thin Size	052752	IO shield with Thin Mini-ITX height for conga-IC175

Table 3 Cables

Cables	Part No.	Description
cab-ThinMini-ITX-SATA-Power	14000120	SATA power cable for congatec Thin Mini-ITX family. One end 15-pin SATA connector to 3x15-pin SATA connector
cab-ThinMini-ITX-UART	14000121	UART cable with 9-pin DSUB connector for congatec Thin Mini-ITX family
cab-ThinMini-ITX-USB20-Single	14000122	Single USB 2.0 cable for congatec Thin Mini-ITX family

Cables	Part No.	Description
cab-ThinMini-ITX-USB20-Twin	14000123	Dual USB 2.0 cable for congatec Thin Mini-ITX family
cab-ThinMini-ITX-LVDS-OE	14000125	LVDS cable with open end for congatec Thin Mini-ITX family. Can be used also for eDP with open end
cab-ThinMini-ITX-BKLT	14000127	Backlight cable for congatec Thin Mini-ITX family
cab-DP to HDMI Passive	14000128	Passive DisplayPort to HDMI cable
cab-ThinMini-ITX-eDP 1-1	14000129	eDP 1-1 cable for congatec Thin Mini-ITX family. Both sides are with 40pin ACES eDP connector plug
SATA III Cable 30 cm, Straigth/Straight	48000029	SATA III cable with 30cm length, shielded, end connectors straight/straight
SATA III Cable 30 cm, Down/Straight	48000030	SATA III cable with 30cm length, shielded, end connectors down/straight

Table 4 Adapters

Adapters	Part No.	Description
conga-Thin MITX/eDP to DP Adapter	052231	eDP to standard DisplayPort evaluation adapter for congatec Thin Mini-ITX boards
conga-Thin MITX/eDP to HDMI Adapter	052232	eDP to standard HDMI evaluation adapter for congatec Thin Mini-ITX boards
conga-Thin MITX/LVDS Adapter	052233	LVDS pin header evaluation adapter for congatec Thin Mini-ITX boards

Table 5 Power Supply

PSUs	Part No.	Description
Power Supply 65 Watt	10000145	65 Watt power supply, 19 V, 3.42 A, plug 7.4x5.1x12.5 mm
Power Supply 90 Watt	10000146	90 Watt power supply, 19 V, 4.74 A, plug 7.4x5.1x12.5 mm

2 Specification

2.1 Feature List

Table 6 Feature Summary

Form Factor	Based on Thin Mini-ITX form factor (170 x 170 mm)	
Processor	7 th Generation Intel® Core™ i7,i5, i3 and Celeron Single Chip Ultra Low TDP Processors	
Memory	Two memory sockets (located on the top side of the conga-IC175). Supports <ul style="list-style-type: none"> - SO-DIMM non-ECC DDR4 modules - Data rates up to 2133 MT/s - Maximum 32 GB capacity (16 GB each) 	
congatec Board Controller	Multi-stage watchdog, non-volatile user data storage, manufacturing and board information, board statistics, hardware monitoring, fan control, I2C bus, Power loss control	
Chipset	Intel® 100 Series PCH-LP integrated in the Multi-Chip Package	
Audio	Realtek ALC888S-VD 7.1 channel High Definition Audio codec	
Ethernet	2x Gigabit Ethernet support via the onboard Intel® I219LM GbE PHY (with AMT 11 support) and Intel® I211 GbE controller	
Graphic Interfaces	Next Generation Intel® HD (610/620). Supports: <ul style="list-style-type: none"> - API (DirectX 12, OpenGL 5.0, OpenCL 2.1) - Intel® QuickSync & Clear Video Technology HD (hardware accelerated video decode/encode/processing/transcode) - Hybrid graphics - Up to 3 independent displays (must be two DDI's (DP, HDMI/DVI) and one eDP/LVDS) 	
	2x DP++ 1x LVDS/eDP	
Back Panel I/O Connectors	2x DisplayPort++ (DP, HDMI,DVI) 1x Mic IN 1x Line OUT	2x Gigabit Ethernet (only connector X5 supports AMT) 4x USB 3.0 (supports also USB 2.0 devices) 1x DC-IN
Onboard I/O Connectors	4x USB 2.0 SATA Interfaces: <ul style="list-style-type: none"> - 2x Standard SATA 3.0 - 1x M.2 SATA SSD slot - 1x SATA power header connector (3.3V, 5V or 12V) PCI Express Interfaces: <ul style="list-style-type: none"> - 1x PCIe x4 slot (Gen. 3) - 1x M.2 slot (type 3042/2242, key B) - 1x Full/half size mini PCIe (x1 lane) 1x LVDS (top side) 1x Backlight 1x Monitor OFF 1x eDP interface (bottom side) 1x Micro-SIM card slot 1x Micro-SD card slot (bottom side)	1x Integrated Sensor Hub (ISH) header 1x Internal power connector (12-24V) 1x Surround 1x Front Panel HD Audio 1x SPDIF out or Digital MIC 1x Stereo speaker Super IO <ul style="list-style-type: none"> - 2x COM ports (COM 2 can be used optionally as ccTALK) - 1x CPU fan with selectable voltage - 1x System fan with selectable voltage - GPOs on feature connector Feature Connector (GPIOs, SPI, SMB, LPC, LID/SLEEP etc) 1x Front panel header (power button, reset, LEDs) 1x Intrusion detection header (case open)

Optional Onboard Interfaces	1x SBM ³ support header 1x SBM ³ power 1x CEC header 1x ccTalk
Other Features	Thermal and voltage monitoring CMOS Battery Beeper congatec standard BIOS (also possible to boot from an external BIOS by triggering the BIOS_DISABLE# signal on the feature connector)
BIOS	AMI Aptio [®] UEFI 5.x firmware, 8/16 MByte serial SPI with congatec Embedded BIOS features
Power Management	ACPI 4.0 compliant with battery support. Also supports Suspend to RAM (S3) and Intel AMT 9.5/10 Configurable TDP Ultra low standby power consumption, deep sleep
Security	Optional discrete TPM 2.0; new AES Instructions for faster and better encryption



Note
Some of the features mentioned in the above feature summary are optional. Check the part number of your SBC and compare it to the option information list on page 11 to determine what options are available on your particular SBC.

2.2 Supported Operating Systems

The conga-IC175 supports the following operating systems.

- Microsoft[®] Windows[®] 10
- Linux 3.x/4.x



Note
The Intel[®] Kaby Lake SoC supports only 64-bit operating systems.

2.3 Mechanical Dimensions

- 170 mm x 170 mm
- Height approximately 20 mm

2.4 Supply Voltage Power

- 12 – 24 V DC \pm 5 %

2.5 Power Consumption

The power consumption values were measured using the following test setup:

- Input voltage +12 V
- conga-IC175 SBC
- conga-IC175 cooling solution
- Microsoft Windows 10 (64 bit)



Note

The CPU was stressed to its maximum workload.

Table 7 Measurement Description

The power consumption values were recorded during the following system states:

System State	Description	Comment
S0: Minimum value	Lowest frequency mode (LFM) with minimum core voltage during desktop idle	
S0: Maximum value	Highest frequency mode (HFM/Turbo Boost)	The CPU was stressed to its maximum frequency
S0: Peak current	Highest current spike during the measurement of "S0: Maximum value". This state shows the peak value during runtime	Consider this value when designing the system's power supply, to ensure sufficient power is supplied during worst case scenarios
S3	SBC is powered by 12 V	
S5	SBC is powered by 12 V	



Note

1. *The fan and SATA drives were powered externally.*
2. *All other peripherals except the LCD monitor were disconnected before measurement.*

Table 8 Power Consumption Values

The tables below provide additional information about the conga-IC175 power consumption. The values are recorded at various operating mode.

Part No.	Memory Size	H.W Rev.	BIOS Rev.	OS (64 bit)	CPU			Current (A)				
					Variant	Cores	Freq. /Max. Turbo	S0: Min	S0: Max	S0: Peak	S3	S5
052900	2 x 4 GB	B.0	R000	Windows 10	Intel® Core™ i5-7300U	2	2.6 /3.0 GHz	0.58	2.29	3.29	0.05	0.03
052901	2 x 4 GB	B.0	R000	Windows 10	Intel® Core™ i3-7100U	2	2.4 GHz/N.A	0.55	2.17	2.99	0.05	0.03
052902	2 x 4 GB	B.0	R000	Windows 10	Intel® Celeron® 3965U	2	2.2 Ghz /N.A	0.44	2.17	3.00	0.04	0.03
052903	2 x 4 GB	B.0	R000	Windows 10	Intel® Core™ i7-7100U	2	2.8 /3.9 GHz	0.53	2.40	3.22	0.05	0.03



With a fast input voltage rise time, the inrush current may exceed the measured peak current.

2.6 Supply Voltage Battery Power

Table 9 CMOS Battery Power Consumption

RTC @	Voltage	Current
-10°C	3V DC	1.44 µA
20°C	3V DC	1.57 µA
70°C	3V DC	1.91 µA



1. Do not use the CMOS battery power consumption values listed above to calculate CMOS battery lifetime.
2. Measure the CMOS battery power consumption in your customer specific application in worst case conditions (for example, during high temperature and high battery voltage).
3. Consider also the self-discharge of the battery when calculating the lifetime of the CMOS battery. For more information, refer to application note AN9_RTC_Battery_Lifetime.pdf on congatec AG website at www.congatec.com/support/application-notes.

2.7 Environmental Specifications

Temperature Operation: 0° to 60°C Storage: -20° to +70°C

Humidity Operation: 10% to 90% Storage: 5% to 95%



The above operating temperatures must be strictly adhered to at all times. Humidity specifications are for non-condensing conditions.

3 Block Diagram

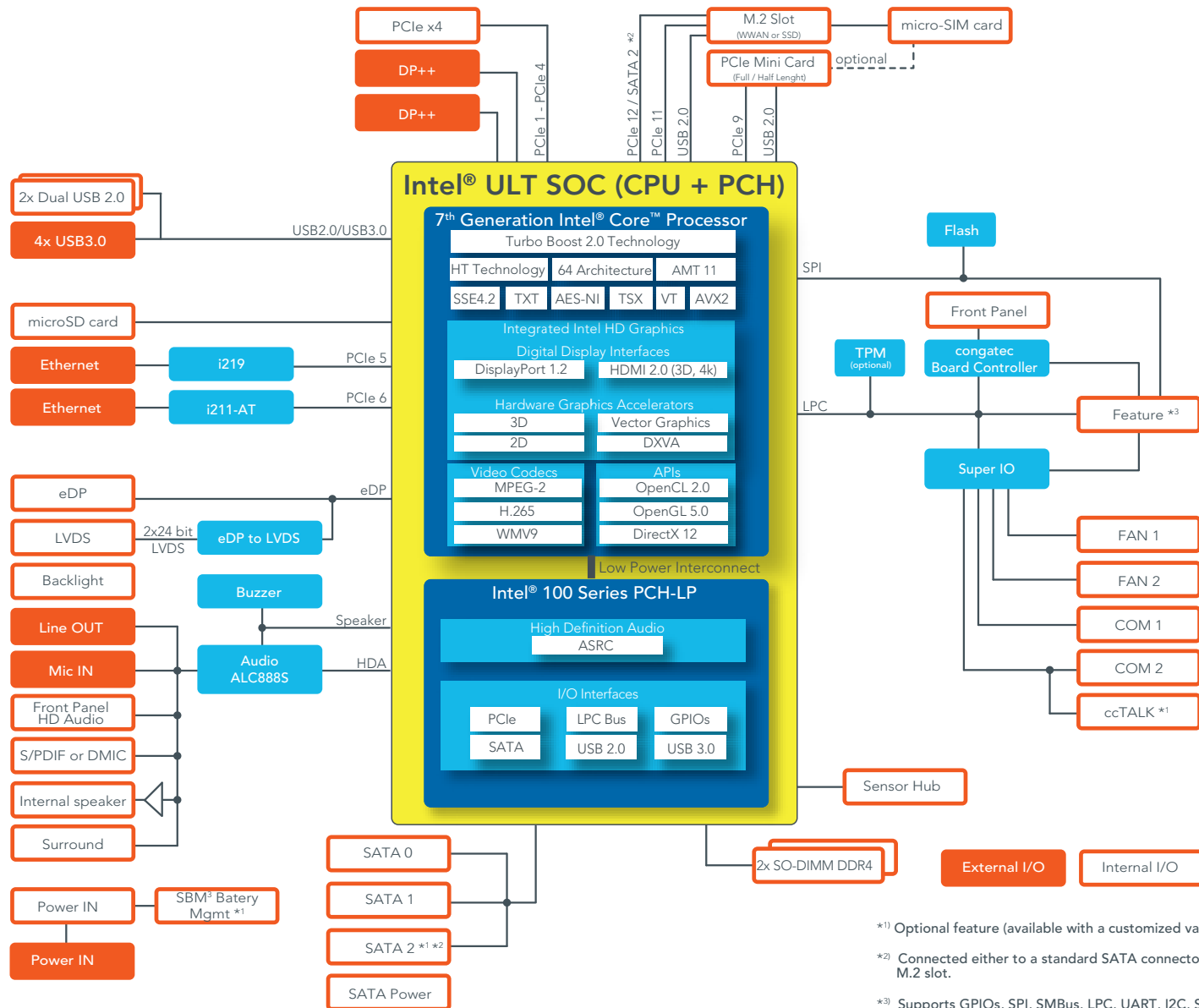

*1) Optional feature (available with a customized variant)

*2) Connected either to a standard SATA connector or to an M.2 slot.

*3) Supports GPIOs, SPI, SMBus, LPC, UART, I2C, Sleep, LID, Watchdog

4 Cooling Solution

The conga-IC175 supports the cooling solutions listed in the table below. The dimensions of the cooling solutions are shown in the sub-sections. All measurements are in millimeters.

Table 10 Cooling Solution Variants

	Cooling Solution	Part No.	Description
1	congatec CSA	052252	Active cooling solution with integrated heatsink and congatec retention frame (PN: 052254)
2	Custom cooling solution	N.A	Custom cooling solution in combination with the congatec retention frame



Note

1. The retention frame acts as mounting backplate and board reinforcement.
2. We recommend a maximum torque of 0.4 Nm for SBC mounting screws and 0.5 Nm for CPU mounting screws.
3. With passive or custom cooling solution, the end user must make sure that adequate air flow is maintained.
4. The congatec conga-IC175 cooling solutions support maximum TDP of 15 W. For applications with higher TDP, you need a custom cooling solution or additional cooling components.



Caution

1. The congatec heatspreaders/cooling solutions are tested only within the commercial temperature range of 0° to 60°C. Therefore, if your application that features a congatec heatspreader/cooling solution operates outside this temperature range, ensure the correct operating temperature of the SBC is maintained at all times. This may require additional cooling components for your final application's thermal solution.
2. For adequate heat dissipation, use the mounting holes on the cooling solution to attach it to the SBC. Apply thread-locking fluid on the screws if the cooling solution is used in a high shock and/or vibration environment. To prevent the standoff from stripping or cross-threading, use non-threaded carrier board standoffs to mount threaded cooling solutions.
3. For applications that require vertically-mounted cooling solution, use only coolers that secure the thermal stacks with fixing post. Without the fixing post feature, the thermal stacks may move.
4. Do not exceed the recommended maximum torque. Doing so may damage the SBC.

4.1 Active Cooling Dimensions

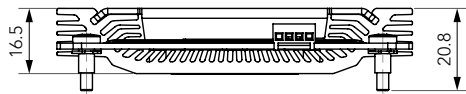
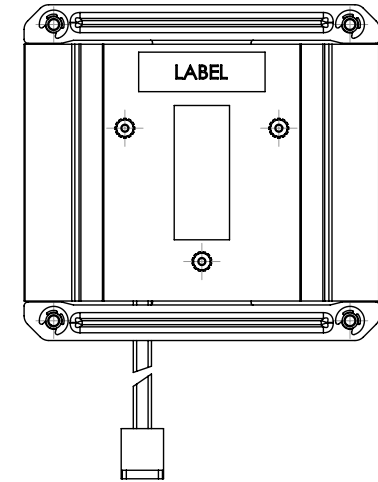
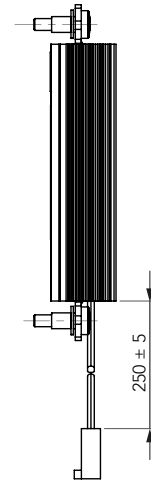
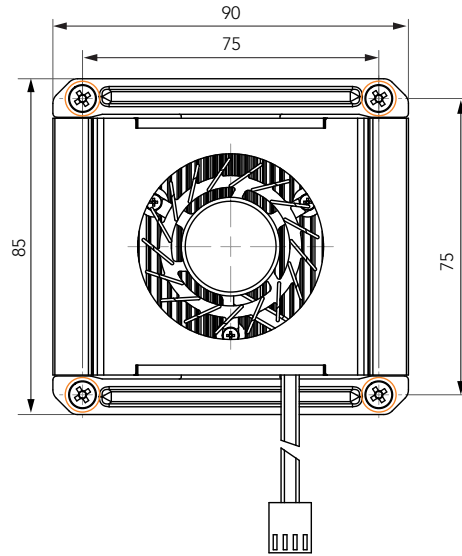

 M3 screws for attaching cooling solution to retention frame

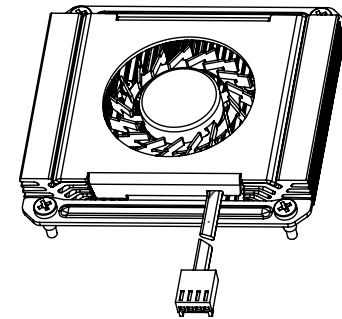
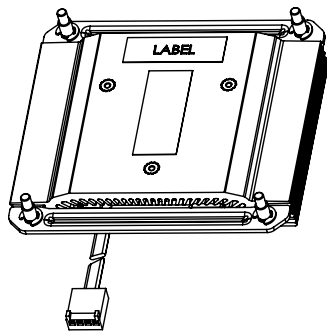

Note

To replace the fan, use equivalent fan with similar parameters.

4.2 Cooling Installation

Assembly Instruction:

- Flip over the SBC and locate the position of the CPU
- Place retention frame on the bottom side of the board with insulating foil facing the PCB & standoffs inserted to mounting holes in PCB. Make sure the retention frame is placed correctly, without touching surrounding components.
- Remove the protection pull tab foil from the phase changer and carefully place the cooling solution. Ensure the cooling solution cable is in position A as shown below.
- Slightly tighten each of the screws so that they hold the cooling solution in place. Start with one screw and then slightly tighten the other screws in a crossover pattern.
- Now you can fully tighten the screws. Once again, start with one and then continue to tighten the other screws in a crossover pattern.
- Connect the fan's power cable to the power connector.

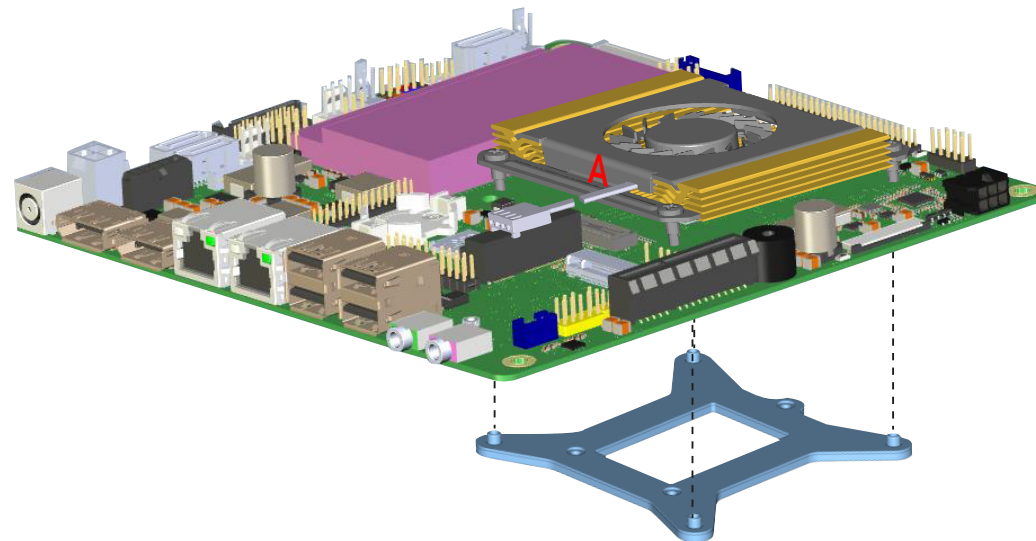

Caution

Wrong placement of the retention frame may damage some electronic components. Before you tighten the cooling solution to the retention frame, ensure the retention frame is aligned properly.

5 Connector Description

5.1 Power Supply

You can power the conga-IC175 SBC with a 12 V – 24 V laptop type DC power supply (on connector X48) or a 4-pin internal power supply (on connector X49).

Additionally, the SBC offers an optional SBM³ power connector (only BOM option). When this connector (X47) is populated, you can power the SBC with it.



Note

The supplied voltages must be within a tolerance of $\pm 5\%$.

5.1.1 DC Power Jack (Rear I/O)

You can power the conga-IC175 SBC with a laptop-type DC power supply, connected to the DC power jack on the back panel. The power input protects against polarity reversal and under/over voltage.

Table 11 Connector X48 Pinout Description

Pin	Function
Inner Shell	+12 - 24 V
Outer Shell	GND

Connector Type

X48 : DC power jack, 7.4 x 5.1 mm diameter



Note

The conga-IC175 turns on immediately you connect a power supply. To change this behavior, set the "Power Loss Control" in the BIOS Boot Settings Configuration menu to "Remain OFF".

DC Power Jack - Connector X48

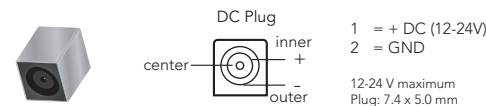

5.1.2 Power Supply (Internal Connector)

The conga-IC175 offers an internal 4-pin power connector. This connector makes it possible to use customized power supply cables or connectors. The power input protects against under voltage or over voltage.

Table 12 Connector X49 Pinout Description

Pin	Signal	Description
1	GND	Ground
2	GND	Ground
3	+12V - 24V	Power supply +12 - 24V
4	+12V - 24V	Power supply +12 - 24V

Internal Power Connector X49

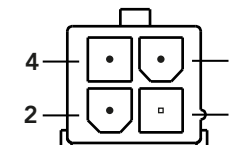

Connector Type

X49 : 2x2-pin, 4.2 mm pitch connector

Mating connector: Molex 87427-0442

Note

The conga-IC175 turns on immediately you connect a power supply. To change this behavior, set the "Power Loss Control" in the BIOS Boot Settings Configuration menu to "Remain OFF".

5.1.3 Optional SBM³ Power Connector (Internal Connector)

You can also power the conga-IC175 SBC optionally (BOM option) with an SBM battery kit. This option requires:

- Connector X47 - SBM battery power connector
- Connector X46 - SBM battery signals connector

Table 13 Connector X47 Pinout Description

Pin	Function
1	+12 - 24V
2	+12 - 24V
3	GND
4	GND
5	N.C

SBM3 Power - Connector X47

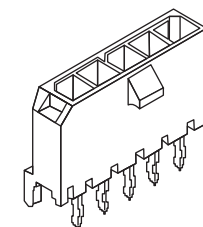

Connector Type

X47 : 1x5-pin, 3 mm pitch Molex Micro-FIT connector

5.1.3.1 Optional SBM3 Signal Connector

For designs that require SBM battery kit, you need the optional power connector X47 and the signal connector X47. The signal connector ensures the conga-IC175 communicates flawlessly with the battery kit.

Table 14 Connector X46 Pinout Description

Pin	Function
1	GND
2	I2C_DAT
3	I2C_CLK
4	BATLOW#
5	SUS_STAT#
6	PM_SLP_S3#
7	PM_SLP_S4#
8	PWRBTN#

SBM3 Signal - Connector X46

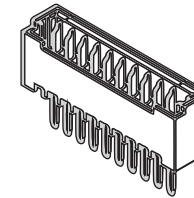

Connector Type

X46 : 8-pin, 1.25 mm pitch Molex PicoBlade connector

5.1.4 Power Status LEDs

The conga-IC175 provides two LED signals (FP_LED+ and P_LED-) on pins 2 and 4 of the front panel connector X39. The signals indicate the different power states of the conga-IC175.

Table 15 LED States

State	FP_LED+	FP_LED-
S0	1	0
S3	0	1
S5	0	0



Note

For the front panel pinout description, see section 6.1 "Front Panel Connector".

5.2 CMOS Battery/RTC

The conga-IC175 provides a board-mounted battery holder (M60) for CMOS battery. The CMOS battery supplies the necessary power required to maintain the CMOS settings and configuration data in the UEFI flash chip. The specified battery type is CR2032

The conga-IC175 offers an optional connector (X44) for external CMOS battery. .

M60 (Battery Holder)



Optional connector X44

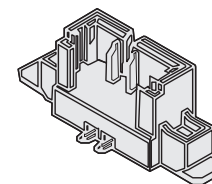

Warning

Danger of explosion if battery is incorrectly replaced. Replace only with same or equivalent type recommended by the manufacturer. Dispose of used batteries according to the manufacturer's instructions.



Connector Type

X44 : 2-pin, 1.25mm pitch Molex PicoBlade header

5.3 PCI Express

The conga-IC175 provides 3 PCIe interfaces—a PCIe M.2 slot on connector X10 (see section 5.6.3), a PCIe x4 slot on connector X7 and a full/half size mini PCIe slot on connector X8.

5.3.1 PCIe x4 Slot

The conga-IC175 offers a PCIe x4 slot on connector X7.

Table 16 PCIe x4 Slot (Connector X7) Pinout Description

Pin	Signal	Pin	Signal
B1	+12V	A1	PRSNT1#
B2	+12V	A2	+12V
B3	+12V	A3	+12V
B4	GND	A4	GND
B5	SMB_CLK	A5	N.C
B6	SMB_DAT	A6	N.C
B7	GND	A7	N.C
B8	+3.3V	A8	N.C
B9	N.C	A9	+3.3V
B10	+3.3V Aux	A10	+3.3V
B11	WAKE#	A11	PCIE_RST#
	Key		
B12	N.C	A12	GND
B13	GND	A13	PCIE_CLK+
B14	PCIE_TX0+	A14	PCIE_CLK-
B15	PCIE_TX0-	A15	GND
B16	GND	A16	PCIE_RX0+
B17	PRSNT2#	A17	PCIE_RX0-
B18	GND	A18	GND
B19	PCIE_TX1+	A19	N.C
B20	PCIE_TX1-	A20	GND
B21	GND	A21	PCIE_RX1+
B22	GND	A22	PCIE_RX1-

PCIe Slot
(Connector X7)

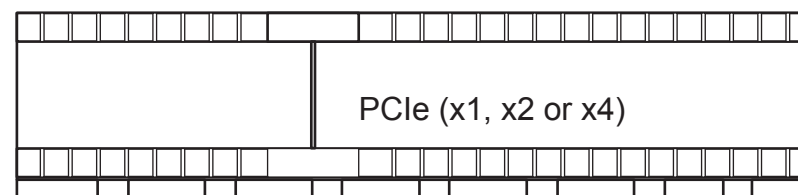

B23	PCIE_TX2+	A23	GND
B24	PCIE_TX2-	A24	GND
B25	GND	A25	PCIE_RX2+
B26	GND	A26	PCIE_RX2-
B27	PCIE_TX3+	A27	GND
B28	PCIE_TX3-	A28	GND
B29	GND	A29	PCIE_RX3+
B30	N.C	A30	PCIE_RX3-
B31	PRSNT#2	A31	GND
B32	GND	A32	RSVD

Connector Type

X7: PCIe x4 connector

5.3.2 Full/half-size Mini PCIe

The conga-IC175 offers a mini PCIe socket on connector X8. This socket is optimized for mobile computing platforms and provides the ability to insert different removable mini PCIe cards. This approach makes it possible to upgrade standard PCIe mini card devices on the SBC, without extra cost of a redesign.

Table 17 mPCIe (Connector X8) Pinout Description

Pin	Signal	Pin	Signal
1	WAKE#	2	+3.3V
3	N.C	4	GND
5	N.C	6	+1.5V
7	CLKREQ#	8	N.C *1
9	GND	10	N.C *1
11	REFCLK-	12	N.C *1
13	REFCLK+	14	N.C *1
15	GND	16	N.C
17	N.C	18	GND
19	N.C	20	W_DISABLE#
21	GND	22	PERST#

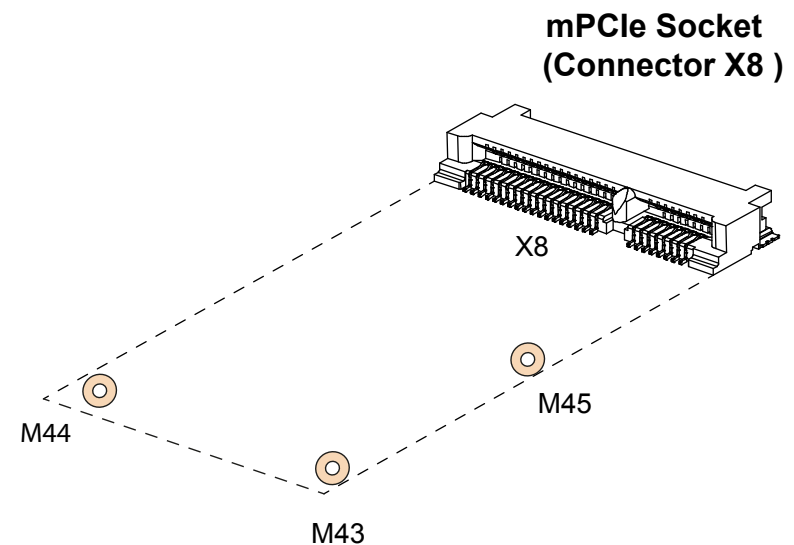

Pin	Signal	Pin	Signal
23	PERn0	24	+3.3V
25	PERp0	26	GND
27	GND	28	+1.5V
29	GND	30	SMB_CLK
31	PETn0	32	SMB_DATA
33	PETp0	34	GND
35	GND	36	USB_D-
37	GND	38	USB_D+
39	+3.3V	40	GND
41	+3.3V	42	N.C
43	GND	44	LED_WLAN# (optional)
45	CL_CLK	46	N.C
47	CL_DATA	48	+1.5V
49	CL_RST#	50	GND
51	N.C	52	+3.3V
53	GND	54	GND

Note

*1 The micro-SIM card slot (connector X11) can optionally be connected to these pins (UIM interface).

Connector Type

X8: PCIe mini card socket

5.3.3 PCI Express Routing

The diagram below shows how the PCIe lanes are routed to the PCIe connectors.

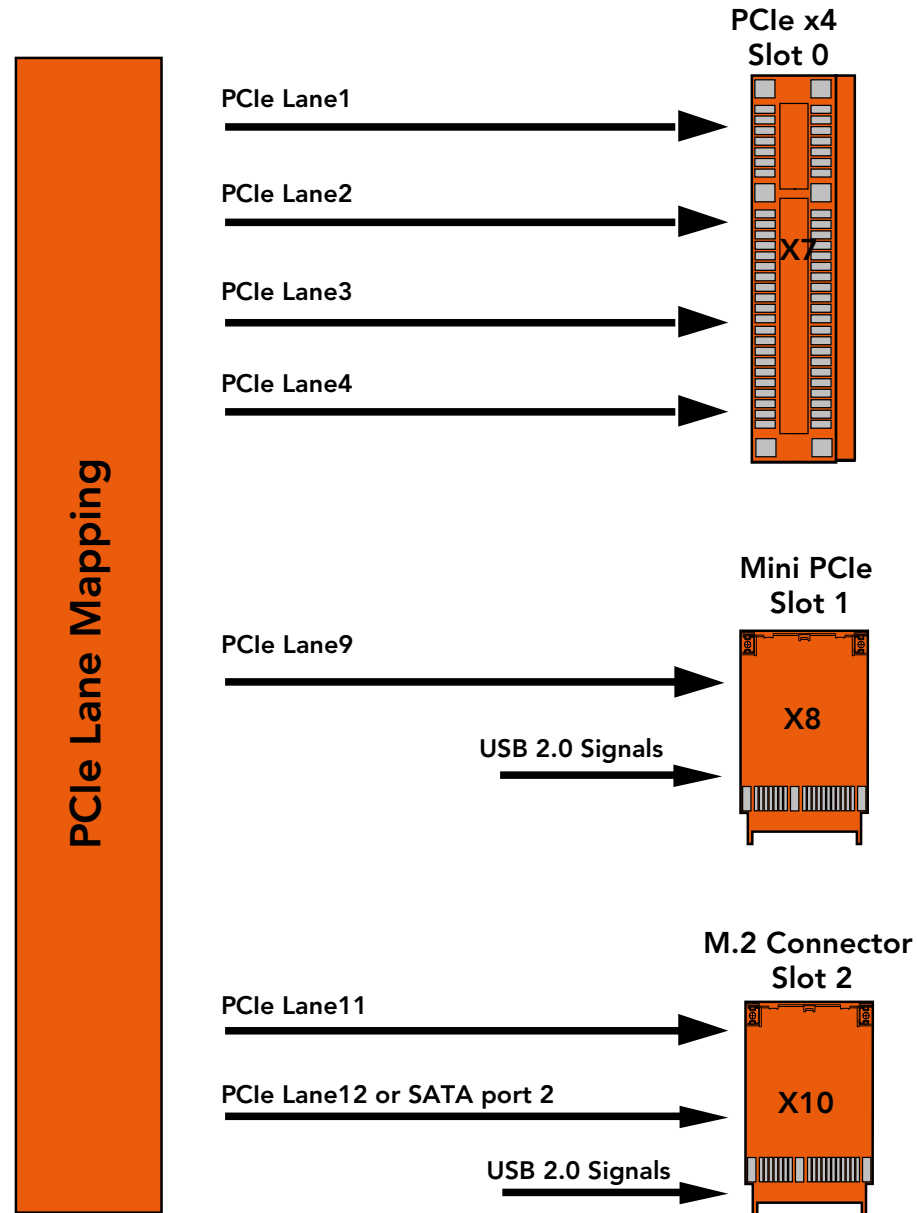

5.4 Display Interfaces

The conga-IC175 supports up to three independent displays. The interfaces supported are two Digital Display Interfaces and one LVDS or eDP interface.

5.4.1 Display Port Interface DP++

The conga-IC175 SBC has two DP++ connectors (X18 and X19) located at the rear I/O panel. These connectors support DP/HDMI/DVI displays.

DP++ Connectors X18/X19

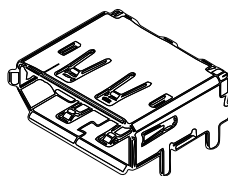

Connector Type

X18,X19: Standard DisplayPort connector

5.4.2 LVDS

The conga-IC175 offers LVDS interface on connector X25 – a 40-pin LVDS connector. The LVDS signals are sourced from incoming eDP stream, via a multiplexer. The multiplexer routes the eDP signals to LVDS connector X25 (via an eDP to LVDS bridge) by default.

The LVDS interface is found on the top side of the SBC and supports

- 24 bit single channel
- selectable backlight voltage
- VESA color mappings
- automatic panel detection
- resolution up to 1920 x 1200 in dual LVDS mode.

Table 18 Connector X25 Pinout Description

Pin	Signal	Pin	Signal
1	LVDS_A3+	21	N.C
2	LVDS_A3-	22	EDID_3.3V
3	LVDS_A2+	23	LCD_GND
4	LVDS_A2-	24	LCD_GND
5	LVDS_A1+	25	LCD_GND
6	LVDS_A1-	26	LVDS_A_CLK+
7	LVDS_A0+	27	LVDS_A_CLK-
8	LVDS_A0-	28	BKLT_GND
9	LVDS_B3+	29	BKLT_GND
10	LVDS_B3-	30	BKLT_GND
11	LVDS_B2+	31	EDID_CLK
12	LVDS_B2-	32	eDP_LVDS_BKLT_EN
13	LVDS_B1+	33	eDP_LVDS_BKLT_CTRL
14	LVDS_B1-	34	LVDS_B_CLK+
15	LVDS_B0+	35	LVDS_B_CLK-
16	LVDS_B0-	36	BKLT_PWR
17	EDID_GND	37	BKLT_PWR
18	LCD_VCC	38	BKLT_PWR
19	LCD_VCC	39	N.C
20	LCD_VCC	40	EDID_DATA

LVDS Connector X25



 **Note**

The maximum output current for LCD and backlight power rails is 2 A.

 **Connector Type**

X25: 0.5 mm, 40-pin ACES connector

Mating connector: ACES 88441-40 or ACES 50204-40

5.4.3 Embedded DisplayPort (eDP)

The conga-IC175 provides eDP interface on connector X20 - a standard 40-pin DisplayPort connector. The eDP signals are sourced from incoming eDP stream via a multiplexer. The multiplexer routes the eDP signals to LVDS connector X25 (via an eDP to LVDS bridge) by default. To route the eDP signals to eDP connector X20, change the 'Active LFP Configuration' in the BIOS setup menu to 'eDP'.

The eDP interface is found on the bottom side of the SBC.

Table 19 Connector X20 Pinout Description

Pin	Signal	Pin	Signal
1	N.C	21	VCC_LCD
2	GND	22	N.C
3	eDP_TX3-	23	GND
4	eDP_TX3+	24	GND
5	GND	25	GND
6	eDP_TX2-	26	GND
7	eDP_TX2+	27	eDP_HPD
8	GND	28	GND
9	eDP_TX1-	29	GND
10	eDP_TX1+	30	GND
11	GND	31	GND
12	eDP_TX0-	32	eDP_LVDS_BKLT_EN
13	eDP_TX0+	33	eDP_LVDS_BKLT_CTRL
14	GND	34	N.C
15	eDP_AUX+	35	N.C
16	eDP_AUX-	36	N.C
17	GND	37	BKLT_PWR
18	VCC_LCD	38	BKLT_PWR
19	VCC_LCD	39	BKLT_PWR
20	VCC_LCD	40	N.C

eDP Connector X20

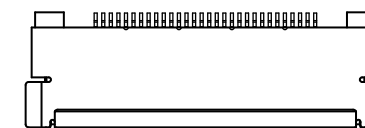

Connector Type

X20: 0.5 mm, 40-pin ACES connector

Mating connector: ACES 88441-40 or ACES 50204-40

5.4.3.1 Backlight Power Connector

The conga-IC175 provides backlight power on connector X22.

Table 20 Connector X22 Pinout Description

Pin	Signal Name	Description
1	eDP_LVDS_BKLT_EN	Backlight enable
2	eDP_LVDS_BKLT_CTRL	Backlight control
3	BKLT_PWR	Backlight inverter power
4	BKLT_PWR	Backlight inverter power
5	GND	Backlight ground
6	GND	Backlight ground
7	Brightness_Up	Flat panel brightness increase
8	Brightness_Down	Flat panel brightness decrease

Connector Type

X22: 2 mm, 8-pin crimp style connector

Mating connector: Chyao Shiunn JS-1124-08

Backlight Power - Connector X22

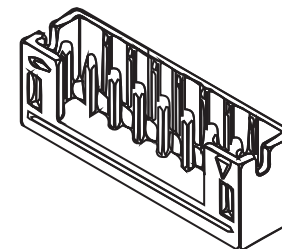

5.4.3.2 Backlight/Panel Power Selection

The conga-IC175 supports different voltages for the panel and backlight. With jumper X23, you can set the panel voltage to 3,3 V, 5 V or 12 V. With jumper X24, you can set the backlight voltage to 5 V or 12 V.

Table 21 Connector X23 Pinout Description

Jumper Position	LCD Voltage
2-4	+3.3 V
3-4	+12 V
4-6	+5 V

Panel Voltage Selector - Jumper X23

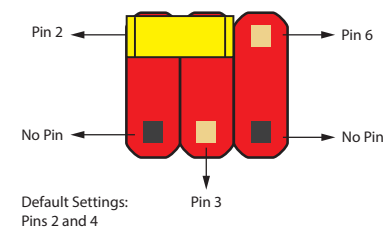

Table 22 Connector X24 Pinout Description

Jumper Position	Backlight Voltage
2-4	N.A
3-4	+12 V
4-6	+5 V

 **Connector Type**

X23, X24: 2.54 mm, 2x3-pin header (without pins 1 and 5)

Backlight Voltage Selector - Jumper X24

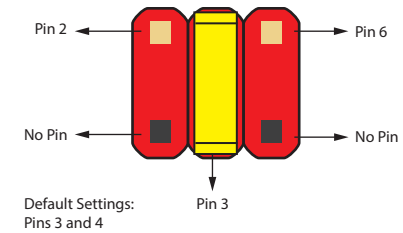

5.4.3.3 Monitor OFF connector

The monitor OFF connector X21 offers the possibility to switch off the displays attached to LVDS or eDP port.

Table 23 Connector X21 Pinout Description

Pin	Function
1	GND
2	MONITOR_OFF#

 **Connector Type**

X21: 2.54 mm, 2-pin Molex KK series connector

Monitor OFF - Connector X21

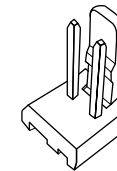

5.5 USB

The conga-IC175 provides 10 USB ports—four on the rear connectors, four internally and two on the mini-PCIe and M.2 connectors.

5.5.1 Rear USB Connectors

The conga-IC175 offers four USB 3.0 ports (port 1-4) on the rear side. These ports are routed directly from the SoC to connectors X13 and X14. The ports support also USB 2.0 devices

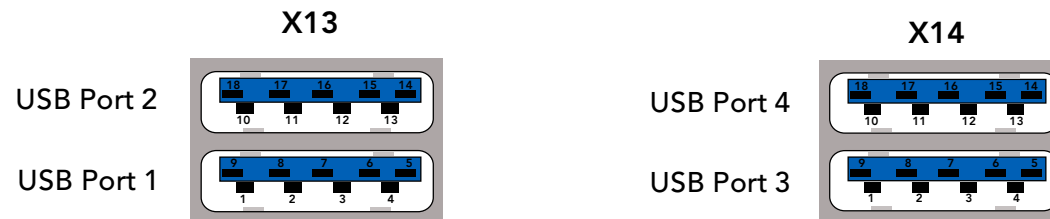

Note
The +5V signals of connector X13 and X14 have a maximum current of 1 A each.

Connector Type

X13,X14: Dual USB 3.0 type A (stacked) connector

5.5.2 Internal USB Connectors

The conga-IC175 offers four USB ports (ports 7-10) internally. Ports 7 and 8 are routed to connector X16 while ports 9 and 10 are routed to connector X15.

Table 24 Connector X16 Pinout Description

USB Port 7			USB Port 8		
Pin	Signal	Description	Pin	Signal	Description
1	+5V	+5 V supply	2	+5V	+5 V supply
3	USB7-	USB Port 7, Data-	4	USB8-	USB Port 8, Data-
5	USB7+	USB Port 7, Data+	6	USB8+	USB Port 8, Data+
7	GND	Ground	8	GND	Ground
9	No Pin	Empty	10	N.C	Not Connected

Internal USB - Connector X16

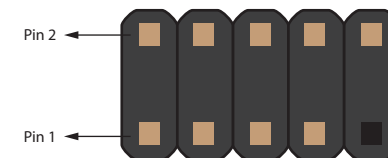
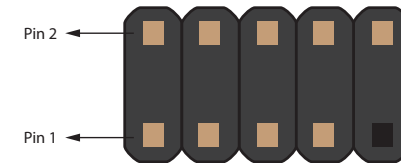

Table 25 Connector X15 Pinout Description

USB Port 9			USB Port 10		
Pin	Signal	Description	Pin	Signal	Description
1	+5V	+5 V supply	2	+5V	+5 V supply
3	USB9-	USB Port 9, Data-	4	USB10-	USB Port 10, Data-
5	USB9+	USB Port 9, Data+	6	USB10+	USB Port 10, Data+
7	GND	Ground	8	GND	Ground
9	No Pin	Empty	10	N.C	Not Connected

Internal USB - Connector X15



Connector Type

X15, X16: 2.54 mm, 2x5-pin header

Note

1. Each port (ports 7-10) has a maximum current of 0.5 A.
2. Connector X16 supports Wake-on-USB feature.

5.6 SATA Interfaces

5.6.1 Standard SATA Ports

The conga-IC175 provides three SATA ports—two standard SATA connectors (X51 and X52) and one M.2 connector (X10). The SATA ports support data rates up to 6 Gbps. The SATA LED on the front panel connector lights when there is activity on any of the SATA interface.

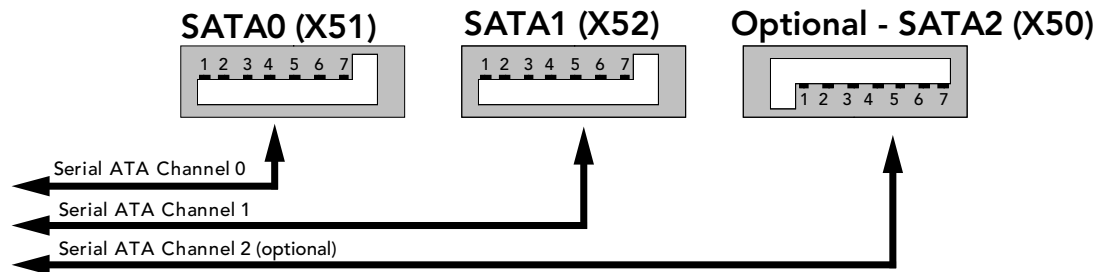



Note

1. The conga-IC175 offers an additional standard SATA connector (X50) via an assembly option (customized variant).
2. Connector X51 supports eSATA devices.
3. Connector X52 supports SATADOM devices on hardware revision A.x and later.



Connector Type

X50,X51,X52: Standard SATA connector

5.6.2 SATA Power

The conga-IC175 provides an internal SATA power for hard drives on connector X12. This connector supplies 3.3 V, 5 V and 12 V.

Table 26 Connector X12 Pinout Description.

Pin	Signal	Pin	Signal	Pin	Signal
1	+3.3V	6	GND	11	GND
2	+3.3V	7	+5V	12	GND
3	+3.3V	8	+5V	13	12V
4	GND	9	+5V	14	12V
5	GND	10	GND	15	12V

SATA Power (X12)

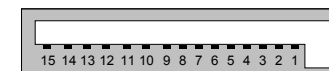

Note

1. Do not power more than two devices at the same time.
2. The +3.3 V, +5 V and +12 V voltage rails have maximum current of 2 A each.



Connector Type

X12: 15-pin standard SATA power connector

5.6.3 M.2 Slot

The conga-IC175 offers an M.2, type 3042/2242 slot (X10) for connecting SATA or PCIe x2 SSDs and WWAN devices.

Table 27 Connector X10 Pinout Description (Revision B.x and later)

Pin	Signal	Pin	Signal
1	CONFIG_3	2	+3.3V
3	GND	4	+3.3V
5	GND	6	FULL_CARD_PWROFF#
7	USB_D+	8	W_DISABLE_1#
9	USB_D-	10	LED1 (optional)
11	GND	12	Key
13	Key	14	
15	Key	16	Key
17		18	
19		20	N.C
21	CONFIG_0	22	N.C
23	WoWWAN#	24	N.C
25	N.C	26	W_DISABLE_2#
27	GND	28	N.C
29	PER1-	30	UIM_RESET
31	PER1+	32	UIM_CLK
33	GND	34	UIM_DATA
35	PET1-	36	UIM_PWR
37	PET1+	38	DEVSLP
39	GND	40	GNSS_SCL
41	PER0-/SATA_B+	42	GNSS_SDA
43	PER0+/SATA_B-	44	GNSS_IRQ
45	GND	46	N.C
47	PET0-/SATA_A-	48	N.C
49	PET0+/SATA_A+	50	RESET#
51	GND	52	CLKREQ#
53	REFCLK-	54	PEWAKE#
55	REFCLK+	56	N.C

M.2 Type B Slot - Connector X10

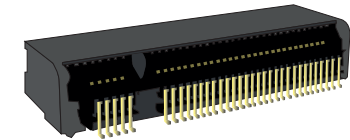

Pin	Signal	Pin	Signal
57	GND	58	N.C
59	N.C	60	N.C
61	N.C	62	N.C
63	N.C	64	N.C
65	N.C	66	N.C
67	RESET#	68	SUSCLK
69	CONFIG_1	70	+3.3V
71	GND	72	+3.3V
73	GND	74	+3.3V
75	CONFIG_2		

Note

1. On hardware revision A.x and earlier, the M.2 slot supports SATA SSD and WWAN (USB 2.0) devices by default, and PCIe x1 devices via a customized BIOS.
2. Micro-SIM card slot (connector 11) is connected to the UIM Interface of the M.2 slot by default.

Connector Type

X10: M.2 type B slot (compatible with card size 3042 or 2242)

5.7 Ethernet

The conga-IC175 provides two Gigabit Ethernet ports (connectors X5 and X6) on the rear side. Only the LAN interface on connector X5 supports Intel AMT technology

Table 28 LED Description

LED Left Side	Description	LED Right Side	Description
Off	10 Mbps link speed	Off	No link
Green	100 Mbps link speed	Steady On	Link established, no activity detected
Orange	1000 Mbps link speed	Blinking	Link established, activity detected

Connector X5/X6

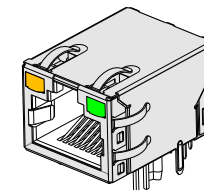

Note

Connector X6 does not support Wake on LAN from S5 mode in Windows 10.



Connector Type

X5/X6: 8-pin RJ45 connector with gigabit magnetic and LEDs

5.8 Audio Interface

The conga-IC175 provides audio connectors internally and on the rear side. The internal audio connectors are stereo speaker, digital microphone/SPDIF and front Panel HD audio. The rear audio connectors are Line-OUT and Mic-IN.

5.8.1 Rear Audio Connectors

The conga-IC175 has a high definition audio codec (Realtek ALC888S) mounted on it. The line output signals and the MIC signals are routed to connectors X31 (Line-OUT) and X29 (MIC-IN) on the rear side respectively. You can find the drivers for this codec at:

<http://www.congatec.com/en/products/mini-itx-single-board-computer/conga-ic175.html>

Table 29 MIC-IN (Connector X29) Pinout Description

Pin	Jack	Signal	Description
1	Tip	MIC1_L	Microphone - left channel
2	Ring	MIC1_R	Microphone - right channel
3	Sleeve	A_GND	Analog ground

MIC IN - Connector X29

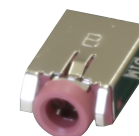

Jack (MIC-IN)

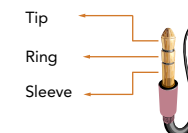

Table 30 Line-OUT (Connector X31) Pinout Description

Pin	Jack	Signal	Description
1	Tip	LINE_L	Line-OUT - left channel
2	Ring	LINE_R	Line-OUT - right channel
3	Sleeve	A_GND	Analog ground

Connector Type

X29, X31: 3-pin, 3.5 mm single audio jack

Line OUT - Connector X31



Jack (Line-IN)

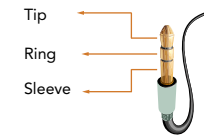

5.8.2 Internal Audio Connectors

The conga-IC175 provides the stereo speaker, digital microphone/SPDIF, front panel HD and surround audio connectors internally.

5.8.2.1 Stereo Speaker Header

The first analog line input channels (left and right) of the Realtek ALC888S HDA audio codec are routed to connector X30, via a TPA2012D2 amplifier. The amplifier offers a maximum wattage of 2.1 W per channel into 4 ohms.

Table 31 Stereo Speaker (Connector X30) Pinout Description

Pin	Signal	Description
1	FRONT_L-	Analog front left (differential negative)
2	FRONT_L+	Analog front left (differential positive)
3	FRONT_R+	Analog front right (differential positive)
4	FRONT_R-	Analog front right (differential negative)

Connector Type

X30: 2 mm, 4-pin crimp style connector

Mating connector: Chyao Shiunn JS-1124-04

Stereo Speaker - Connector X30

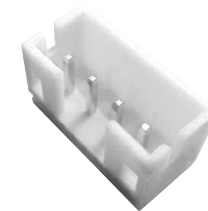

5.8.2.2 Digital Microphone/SPDIF

The Digital Microphone/SPDIF signals of the Realtek ALC888S HDA audio codec are routed to the internal digital microphone/SPDIF connector X28. This connector offers two power supply pins (3,3 V and 5 V). Power Budget of these pins is limited to 500 mA.

Internal Digital Microphone/SPDIF (Connector X28) Pinout Description

Pin	Signal	Description
1	+3.3V	3.3V supply
2	DMIC_DATA	Serial data from digital MIC
3	GND	Ground
4	SPDIFO2/DMIC_CLK	S/PDIF output or Digital MIC serial clock (configurable)
5	KEY	No pin
6	+5V	5 V supply

Connector Type

X28: 2.54 mm, 1x6-pin header

Digital MIC/SPDIF - Connector X28

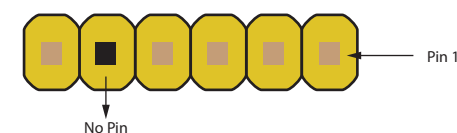

5.8.2.3 Front Panel (HD Audio/AC97)

The front panel HD audio signals of the Realtek ALC888S HDA audio codec are routed to connector X27. The pinout description of the connector is shown below:

Table 32 HDA/AC97 Front Panel (Connector X27) Pinout Description

Pin	Signal	Description
1	MIC2_L	2nd analog stereo microphone input - left channel
2	GND_HDA	Audio ground
3	MIC2_R	2nd analog stereo microphone input - right channel
4	PRESENCE#	Active low signal that indicates that an Intel HD Audio dongle is connected to the analog header.
5	LINE2_R	2nd analog line output - right channel (headphone)
6	MIC2_JD	Microphone jack detection
7	SENSE	Jack detection for HDA codec
8	KEY	No pin
9	LINE2_L	2nd analog line output - left channel (headphone)
10	LINE2_JD	Line output jack detection

Front Panel Audio - Connector X27

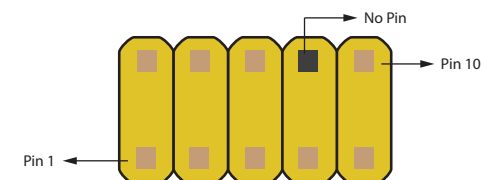

Connector Type

X27: 2.54 mm, 2x5-pin header

5.8.2.4 Surround header

The surround signals of the Realtek ALC888S HDA audio codec are routed to the internal surround connector.

Table 33 Surround (Connector X26) Pinout Description

Pin	Signal	Description	Pin	Signal	Description
1	LINE1_L	1st Analog line input left channel	2	A_GND	Analog ground
3	A_GND	Analog ground	4	LINE1_R	1st Analog line input right channel
5	SIDE_L	Analog side output left channel	6	A_GND	Analog ground
7	A_GND	Analog ground	8	SIDE_R	Analog side out right channel
9	SURR_L	Analog surround out left channel	10	A_GND	Analog ground
11	A_GND	Analog ground	12	SURR_R	Analog surround out right channel
13	CENTER	Analog center output	14	A_GND	Analog ground
15	A_GND	Analog ground	16	LFE	Analog low frequency output
17	-	No pin	18	SENSE	Jack detection for HDA codec

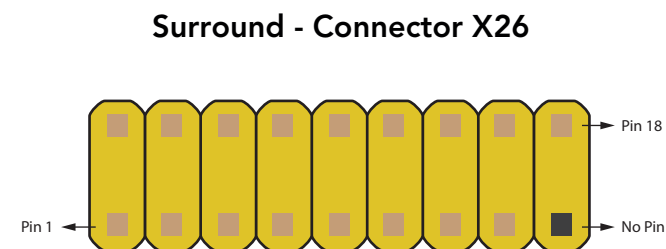

Connector Type

X26: 2 mm, 2x9-pin header

5.9 SMBus

The SMBus signals are available in different locations on the conga-IC175, including the feature connector (X38) described in section 6.12.

5.10 SPI Bus

The SPI signals are connected to the onboard SPI flash and the feature connector (X38). With the SPI signals on the feature connector, you can start the conga-IC175 from an external flash. This however requires a customized adapter to trigger the BIOS_DISABLE# signal (pin 46) of the feature connector.

Note

The congatec customized adapter for the feature connector is for internal use only.

5.11 I²C Bus

The congatec board controller provides I²C signals. These signals are available in different locations on the conga-IC175, including the feature connector (X38) described in section 6.12 of this document.

5.12 LPC Super I/O Device

The conga-IC175 has an onboard Super I/O controller. The controller is connected to the SoC's LPC bus and provides additional interfaces such as two serial interfaces, optional ccTALK, GPOs, 4-wire CPU and system fans. .

5.12.1 GPIOs

The conga-IC175 SBC provides eight General Purpose Inputs via the congatec board controller and eight General Purpose Outputs via the onboard Super I/O. The GPIO signals are routed to the feature connector (X38) described in section 6.12 "Feature Connector".

5.12.2 Serial Ports (COM)

The Super I/O controller on the conga-IC175 provides two fully featured RS-232 compliant UART interfaces (COM 1 and 2). The COM ports support data rates up to 250 kbps with worst-case loads of 3k Ω , in parallel with 1nF.

Table 34 Serial Ports (Connectors X34/X37) Pinout Description

Pin	Signal	Description	Pin	Signal	Description
1	DCD	Data Carrier Detect	2	RXD	Received Data
3	TXD	Transmit Data	4	DTR	Data Terminal Ready
5	GND	Ground	6	DSR	Data Set Ready
7	RTS	Request to Send	8	CTS	Clear to Send
9	RI	Ring Indicator	10	N.C	Not connected



Note

The conga-IC175 offers an optional ccTALK interface. This interface uses transmit and receive signals of COM 2. If this option is implemented, COM 2 will not be available.

Connector Type

X34,X37: 2.54 mm, 2x5-pin headers

COM 1 & 2 - Connectors X34/X37

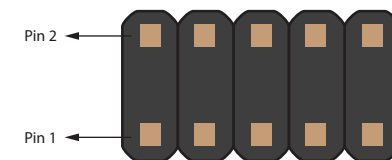

5.12.3 CPU/System Fan Connector & Power Configuration

The conga-IC175 supports 5V or 12V CPU and system fans. The signals of the CPU and system fans are routed to connectors X33 and X36 respectively. Use jumper X32 to select the voltage of the CPU fan and jumper X35 to select the voltage of the system fan.

Table 35 CPU/SYS Fan Pinout

X33/X36 Pin	Signal
1	GND
2	VCC +5 VDC/+12 VDC
3	FAN_TACHOIN
4	FAN_CTRL

Jumper X32, X35	Configuration
1 - 2	FAN +12 VDC (default)
2 - 3	FAN +5 VDC



Note

The maximum power of both CPU and SYS fan is 5 W.

Connector Type

X33, X36: 2.54 mm, 4-pin grid female fan connector

X32, X35: 2.54 mm grid jumper

CPU Fan (X33)

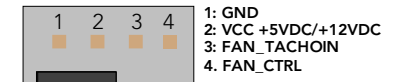

X32 X35

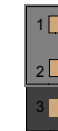

SYS Fan (X36)

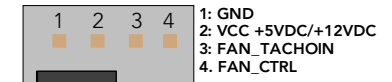

6 Additional Features

6.1 Front Panel Connector

The conga-IC175 SBC supports front panel features such as power button, status LEDs and reset button via connector X39—a 10-pin internal header. The FP_LED+ and FP_LED- signals communicate the system states to two LEDs connected to this header.

See section 5.1.4 “Power Status LED” for the possible power states and corresponding LED status.

Table 36 Front Panel (Connector X39) Pinout Description

Pin	Signal	Description
1	HDD_POWER_LED+	Hard disk activity LED (anode)
2	FP_LED+	Power LED (main color)
3	HDD_LED	Hard disk activity LED (cathode)
4	FP_LED-	Power LED (alternate color)
5	GND	Ground
6	PWRBTN#	Power Button
7	SYS_RST#	Reset Button
8	GND	Ground
9	+V5S	+5 V power supply (500 mA power budget)
10	KEY	No pin

Front Panel - Connector X39



Connector Type

X39: 2.54 mm, 10-pin header

6.2 Micro-SIM Card

The conga-IC175 offers a micro-SIM slot on connector X11 for inserting SIM card.

Table 37 Connector X11 Pinout Description

Pin	Signal	Description
C1	PWR	Power
C2	RST	Reset
C3	CLK	Clock
C4	N.A	Not available
C5	GND	Ground
C6	VPP	Programming voltage input
C7	I/O	Data
C8	N.A	Not available

SIM Slot - Connector X11

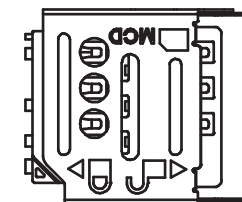

Note

1. The micro-SIM card slot is connected to the UIM interface of the M.2 slot by default.
2. The slot can optionally be connected to the UIM interface of the mPCIe slot.



Connector Type

X11: Micro-SIM card socket (Molex 78800 series)

6.3 Micro-SD Card

The conga-IC175 offers a micro-SD slot on connector X60. The SD card slot complies with SDXC card specification 3.0 with support for up to 104 MBps data rate.

Table 38 Connector X60 Pinout Description

Pin	Signal	Description
1	SD_D2	Data line (bit 2)
2	SD_D3	Data line (bit 3)
3	SD_CMD	Command response

Micro-SD Slot (Connector X60)

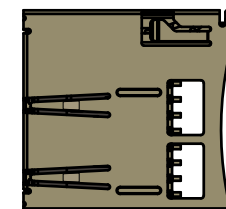

Pin	Signal	Description
4	+3.3V	Supply voltage
5	SD_CLK	Serial clock
6	GND	Ground
7	SD_D0	Data line (bit 0)
8	SD_D1	Data line (bit 1)

Connector Type

X60: Micro-SD card slot

6.4 Integrated Sensor Hub

The conga-IC175 offers an Integrated Sensor Hub (ISH) on connector X61.

Table 39 ISH (Connector X61) Pinout Description

Pin	Signal	Pin	Signal
1	+3.3V	2	+5V
3	+3.3V	4	RSVD
5	N.C	6	I2C0_SDA
7	N.C	8	I2C0_SCL
9	GND	10	I2C1_SDA
11	UART0_RXD	12	I2C1_SCL
13	UART0_TXD	14	GND
15	UART0_RTS	16	GPIO0
17	UART0_CTS	18	GPIO1
19	GND	20	GPIO2
21	UART1_RXD	22	GPIO3
23	UART1_TXD	24	GPIO4
25	UART1_RTS	26	N.C
27	UART1_CTS	28	N.C
29	GND	30	N.C

Connector Type

X61: 2 mm, 2x15-pin header

ISH - Connector X61

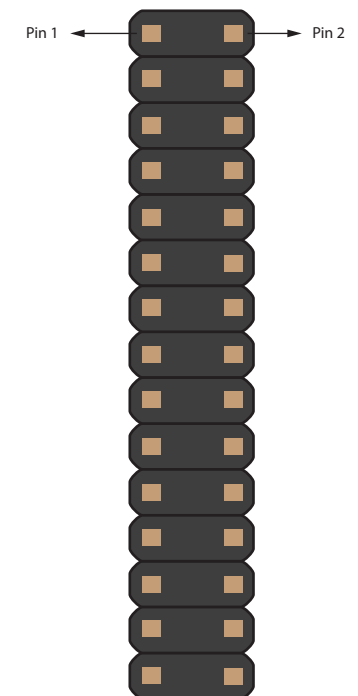

6.5 Case Open Intrusion Connector

The conga-IC175 provides connector X2 for case-open intrusion detection.

Table 40 Case Open Intrusion (Connector X2) Pinout Description

Pin	Function
1	GND
2	INTRUDER#



Connector Type

X2: 2.54 mm, 2-pin Molex KK series connector

Case Open Intrusion - Connector X2

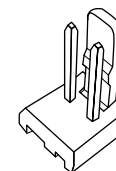

6.6 Optional TPM

The conga-IC175 SBC can be equipped optionally with a TPM 2.0 compliant security chip. The chip is connected to the LPC bus provided by the integrated Intel chipset.

The UEFI boot firmware on the SBC initializes the TPM chip.

6.7 congatec Board Controller (cBC)

The conga-IC175 is equipped with a Texas Instruments Tiva™ microcontroller. This onboard microcontroller plays an important role for most of the congatec BIOS features. It fully isolates some of the embedded features such as system monitoring or the I²C bus from the x86 core architecture, which results in higher embedded feature performance and more reliability, even when the x86 processor is in a low power mode.

6.7.1 Fan Control

The conga-IC175 has additional signals and functions to further improve system management. One of these signals is an output signal called FAN_PWMOUT that allows system fan control using a PWM (Pulse Width Modulation) output. Additionally, there is an input signal called FAN_TACHOIN that provides the ability to monitor the system's fan RPMs (revolutions per minute). This signal must receive two pulses per revolution in order to produce an accurate reading. For this reason, a two pulse per revolution fan or similar hardware solution is recommended.

6.7.2 Power Loss Control

The cBC has full control of the power-up of the SBC and therefore can be used to specify the behavior of the system after an AC power loss condition. Supported modes are "Always On", "Remain Off" and "Last State".

6.7.3 Board Information

The cBC provides a rich data-set of manufacturing and board information such as serial number, EAN number, hardware and firmware revisions, and so on. It also keeps track of dynamically changing data like runtime meter and boot counter.

6.8 Embedded BIOS

The conga-IC175 is equipped with congatec Embedded BIOS, which is based on American Megatrends Inc. Aptio UEFI firmware. The BIOS provides the features described below:

6.8.1 OEM Default Settings and OEM BIOS Logo

This feature allows system designers to create and store their own default configuration and BIOS logo (splash screen) within the BIOS flash device. Customized BIOS development by congatec for these changes is no longer necessary because customers can easily do these changes by themselves using the congatec system utility CGUTIL.

6.8.2 OEM BIOS Code

With the congatec embedded BIOS it is even possible for system designers to add their own code to the BIOS POST process. Except for custom specific code, this feature can also be used to support Window 7 SLIC table, verb tables for HDA codecs, rare graphic modes and Super I/O controllers.

For more information about customizing the congatec embedded BIOS, refer to the congatec system utility user's guide (CGUTLm1x.pdf) and can be found on the congatec AG website at www.congatec.com or contact congatec technical support.

6.8.3 congatec Battery Management Interface

In order to facilitate the development of battery powered mobile systems based on embedded modules, congatec AG defined an interface for the exchange of data between a CPU module (using an ACPI operating system) and a smart battery system. A system developed according to the congatec Battery Management Interface Specification can provide the battery management functions supported by an ACPI-capable operating system (e.g. charge state of the battery, information about the battery, alarms/events for certain battery states, ...) without the need for additional modifications to the system BIOS.

The conga-IC175 BIOS fully supports this interface. For more information about this subject, visit the congatec website and view the following documents:

- congatec Battery Management Interface Specification
- Battery System Design Guide
- conga-SBM³ User's Guide

6.8.4 API Support (CGOS)

In order to benefit from the above mentioned non-industry standard feature set, congatec provides an API that allows application software developers to easily integrate all these features into their code. The CGOS API (congatec Operating System Application Programming Interface) is the congatec proprietary API that is available for all commonly used Operating Systems such as Win32, Win64, Win CE and Linux. The architecture of the CGOS API driver provides the ability to write application software that runs unmodified on all congatec CPU modules. All the hardware related code is contained within the congatec embedded BIOS on the module. See section 1.1 of the CGOS API software developers guide, which is available on the congatec website .

6.9 Thermal/Voltage Monitoring

The conga-IC175 SBC features three temperature sensors - the CPU, memory and board controller sensors. The board controller monitors the +12 V rail.

6.10 Beeper

The board-mounted speaker (M16) provides audible error code (beep code) information during POST.

Beeper (M16)



6.11 External System Wake Event

The conga-IC175 supports LAN, USB, PCIe and PWRBTN driven wake up events.

6.12 Feature Connector

The conga-IC175 provides an internal 50-pin, 2mm pin header as feature connector. The pinout is described below:

Table 41 Feature Connector X38 Pinout Description

Pin#	Signal Name	Pin Type	Voltage Level	Onboard Termination	Description
1	+5V	Power	5V		+5V runtime power output (500 mA max).
2	GND	Ground			
3	LAD0	I/O	3.3V		LPC command, address, data 0
4	LAD1	I/O	3.3V		LPC command, address, data 1
5	LAD2	I/O	3.3V		LPC command, address, data 2
6	LAD3	I/O	3.3V		LPC command, address, data 3
7	LFRAME#	Output	3.3V		LPC frame (start of cycle)
8	SERIRQ#	I/O	3.3V	PU 10k	Serial Interrupt Request
9	LPC_CLK (24 MHz)	Output	3.3V		24 MHz clock signal for external LPC device
10	PLT_RST#	Output	3.3V standby		System reset, active low
11	SMB_DAT	I/OD	3.3V standby	PU 4k7	SMBus data
12	SMB_CLK	OD	3.3V standby	PU 4k7	SMBus clock output, up to 100 kHz
13	SMB_ALERT#	Input	3.3V standby	PU 2k2	SMBus Alert (system wake or SMI), active low
14	GND	Ground			
15	TX_CGBC	Output	3.3V standby		UART transmit port from congatec board controller (a debug port)
16	RX_CGBC	Input	3.3V standby	PU 10k	UART receive port from congatec board controller (a debug port)
17	GPO0	Output	3.3V	PU 4k7	General purpose output from Super IO (LPC)
18	GPO1	Output	3.3V	PU 4k7	General purpose output from Super IO (LPC)
19	GPO2	Output	3.3V	PU 4k7	General purpose output from Super IO (LPC)
20	GPO3	Output	3.3V	PU 4k7	General purpose output from Super IO (LPC)
21	GPO4	Output	3.3V	PU 4k7	General purpose output from Super IO (LPC)
22	GPO5	Output	3.3V	PU 4k7	General purpose output from Super IO (LPC)

Feature Connector X38



23	GPO6	Output	3.3V	PU 4k7	General purpose output from Super IO (LPC)
24	GPO7	Output	3.3V	PU 4k7	General purpose output from Super IO (LPC)
25	GPI0	Input	3.3V	PU 10k	General purpose input to Board controller
26	GPI1	Input	3.3V	PU 10k	General purpose input to congatec Board controller
27	GPI2	Input	3.3V	PU 10k	General purpose input to congatec Board controller
28	GPI3	Input	3.3V	PU 10k	General purpose input to congatec Board controller
29	GPI4	Input	3.3V	PU 10k	General purpose input to congatec Board controller
30	GPI5	Input	3.3V	PU 10k	General purpose input to congatec Board controller
31	GPI6	Input	3.3V	PU 10k	General purpose input to congatec Board controller
32	GPI7	Input	3.3V	PU 10k	General purpose input to congatec Board controller
33	SLP_S3#	Output	3.3V standby	PD 100k	S3 sleep control (suspend to RAM), active low
34	SLP_S5#	Output	3.3V standby		S5 sleep control (Soft Off), active low
35	SLP_S4#	Output	3.3V standby	PD 100k	S4 sleep control (suspend to Disk), active low
36	LID_BTN#	Input	3.3V standby	PU 10k	Connect directly to LID switch, active low
37	SLP_BTN#	Input	3.3V standby	PU 10k	Connect directly to sleep button, active low
38	THRM#	Input	3.3V	PU 10k	External thermal event, active low. Use open drain configuration on external device
39	WDOUT	Output	3.3V	PD 10k	Watchdog output event (board controller)
40	WDTRIG#	Input	3.3V	PU 10k	Watchdog trigger input (board controller), timer reset, active low. Use open drain configuration on external device
41	I2C_DAT	I/OD	3.3V standby	PU 2k2	I2C data bus from board controller (general use)
42	PWR_OK (optional)	Input	VIN	PU 470k PD 150k	Assembly option only. Power good signal from external PSU or voltage monitor. Use open drain configuration on external device. Onboard power rails are disabled if signal is low.
43	SPI_CS#	Output	3.3V standby	PU 10k	SPI chip select for external SPI flash
44	I2C_CLK	OD	3.3V standby	PU 2k2	I2C clock bus from board controller (general use)
45	SPI_MISO	Input	3.3V standby		External SPI flash data output
46	BIOS_DIS#	Input	3.3V standby	PU 10k	External SPI flash enable (boot from external SPI flash), active low
47	SPI_CLK	Output	3.3V standby		External SPI flash clock input
48	SPI_MOSI	Output	3.3V standby		External SPI flash data input
49	+5V standby	Power	5V standby		+5V standby power, 500mA max
50	GND	Ground			



Connector Type

X38: 2 mm, 2x25-pin header

7 conga-IC175 Mechanical Drawing

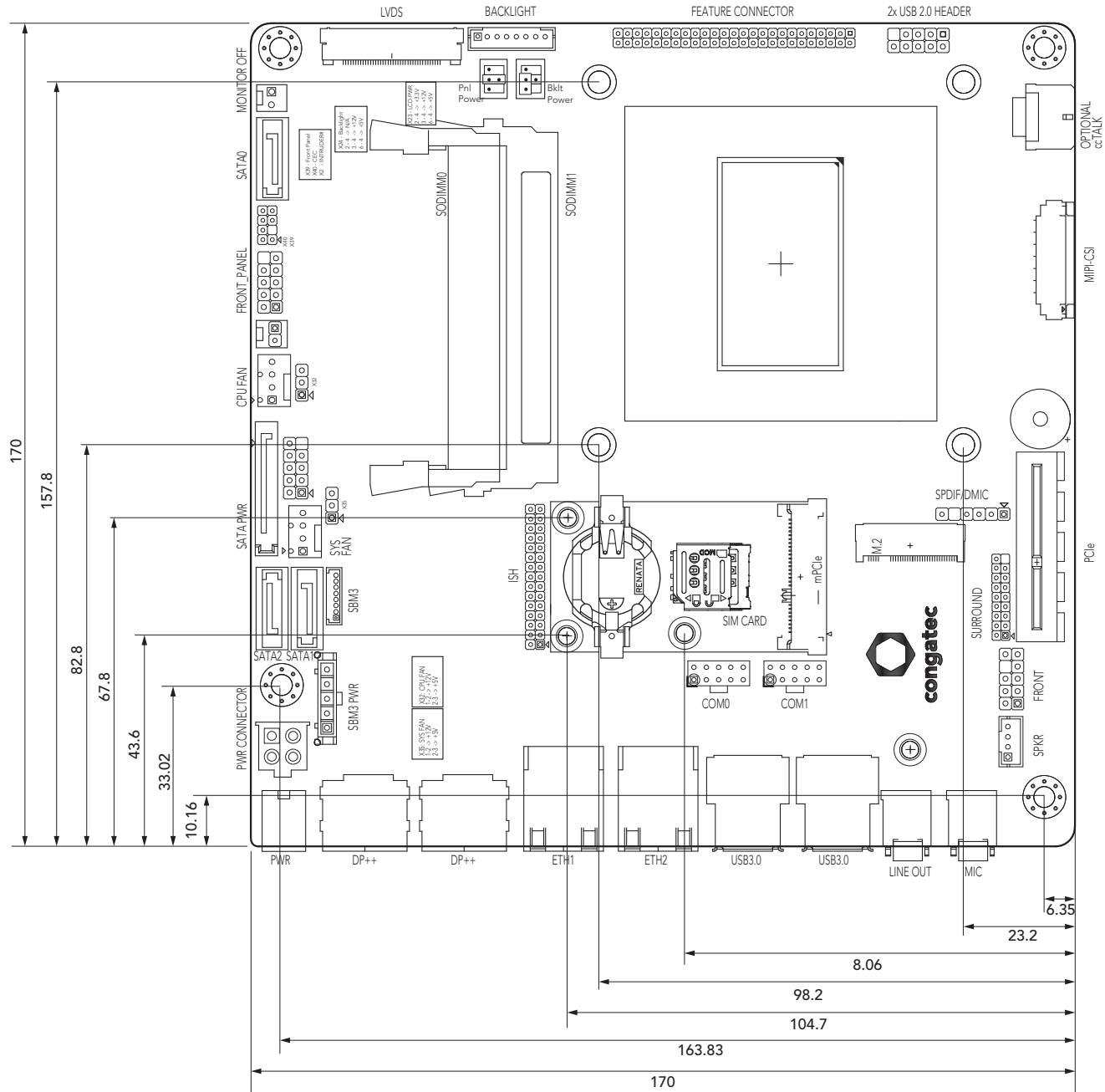

8 BIOS Setup Description

The BIOS setup description of the conga-IC175 can be viewed without having access to the module. However, access to the restricted area of the congatec website is required in order to download the necessary tool (CgMlfViewer) and Menu Layout File (MLF).

The MLF contains the BIOS setup description of a particular BIOS revision. The MLF can be viewed with the CgMlfViewer tool. This tool offers a search function to quickly check for supported BIOS features. It also shows where each feature can be found in the BIOS setup menu.

For more information, read the application note "AN42 - BIOS Setup Description" available at www.congatec.com.



Note

If you do not have access to the restricted area of the congatec website, contact your local congatec sales representative.

8.1 Navigating the BIOS Setup Menu

The BIOS setup menu shows the features and options supported in the congatec BIOS. To access and navigate the BIOS setup menu, press the or <F2> key during POST. The right frame displays the key legend. Above the key legend is an area reserved for text messages. These text messages explain the options and the possible impacts when changing the selected option in the left frame.

8.2 BIOS Versions

The BIOS displays the BIOS project name and the revision code during POST, and on the main setup screen. The initial production BIOS for conga-IC175 is identified as IVKLR1xx or IUKLR1xx, where:

- R is the identifier for a BIOS ROM file
- 1 is the feature number
- xx is the major and minor revision number

The IVKL binary size is 16 MB. The IUKL binary size is 8 MB.

8.3 Updating the BIOS

BIOS updates are recommended to correct platform issues or enhance the feature set of the module. The conga-IC175 features a congatec/AMI AptioEFI firmware on an onboard flash ROM chip. You can update the firmware with the congatec System Utility. The utility has five versions—UEFI shell, DOS based command line¹, Win32 command line, Win32 GUI, and Linux version.

For more information about “Updating the BIOS” refer to the user’s guide for the congatec System Utility “CGUTLm1x.pdf” on the congatec website at www.congatec.com.



Note

¹. *Deprecated.*



Caution

The DOS command line tool is not officially supported by congatec and therefore not recommended for critical tasks such as firmware updates. We recommend to use only the UEFI shell for critical updates.

8.4 Supported Flash Devices

The conga-IC175 supports the following flash devices for external BIOS:

- Winbond W25Q128JVS1Q (16 MB)
- Winbond W25Q64JVSS1Q (8 MB)









For more information about external BIOS support, refer to the Application Note “AN7_External_BIOS_Update.pdf” on the congatec website at <http://www.congatec.com>.

Our company network supports you worldwide with offices in Germany, Austria, Switzerland, the UK and the USA. For more information please contact:

Headquarters

<p>Germany</p> 		<p>FORTEC Elektronik AG Augsburger Str. 2b 82110 Germering</p>	<p>Phone: +49 89 894450-0 E-Mail: info@fortecaq.de Internet: www.fortecaq.de</p>
--	---	---	---

Fortec Group Members

<p>Austria</p> 	 <p>A FORTEC GROUP MEMBER</p>	<p>Distec GmbH, Office Vienna Nuschinggasse 12 1230 Wien</p>	<p>Phone: +43 1 8673492-0 E-Mail: info@distec.de Internet: www.distec.de</p>
<p>Germany</p> 	 <p>A FORTEC GROUP MEMBER</p>	<p>Distec GmbH Augsburger Str. 2b 82110 Germering</p>	<p>Phone: +49 89 894363-0 E-Mail: info@distec.de Internet: www.distec.de</p>
<p>Switzerland</p> 	 <p>A FORTEC GROUP MEMBER</p>	<p>ALTRAC AG Bahnhofstraße 3 5436 Würenlos</p>	<p>Phone: +41 44 7446111 E-Mail: info@altrac.ch Internet: www.altrac.ch</p>
<p>United Kingdom</p> 	 <p>A FORTEC GROUP MEMBER</p>	<p>Display Technology Ltd. Osprey House, 1 Osprey Court Hichingbrooke Business Park Huntingdon, Cambridgeshire, PE29 6FN</p>	<p>Phone: +44 1480 411600 E-Mail: info@displaytechnology.co.uk Internet: www.displaytechnology.co.uk</p>
<p>USA</p> 	 <p>A FORTEC GROUP MEMBER</p>	<p>Apollo Display Technologies, Corp. 87 Raynor Avenue, Unit 1 Ronkonkoma, NY 11779</p>	<p>Phone: +1 631 5804360 E-Mail: info@apolloDisplays.com Internet: www.apolloDisplays.com</p>