



 APOLLO DISPLAY
TECHNOLOGIES



 DISTEC



 DISPLAY
TECHNOLOGY



Manual

ADVANTECH

AIMB-218

Industrial Mini-ITX Motherboard with Intel® Elkhart Lake

Pentium®, Celeron® or Atom™ Processor



WISE-DeviceOn C E FC 

The information contained in this document has been carefully researched and is, to the best of our knowledge, accurate. However, we assume no liability for any product failures or damages, immediate or consequential, resulting from the use of the information provided herein. Our products are not intended for use in systems in which failures of product could result in personal injury. All trademarks mentioned herein are property of their respective owners. All specifications are subject to change without notice.

AIMB-218

AIMB-218 Intel® Pentium J6426 & Celeron J6412/J6413 & Celeron N6210/N6211 & Atom x6413E Mini-ITX HDMI/DP/LVDS (or eDP), 6 COM, and Dual LAN, 8 USB, 1 M.2 B key and 1 M.2 E key, PCIe x1

Copyright

The documentation and the software included with this product are copyrighted 2021 by Advantech Co., Ltd. All rights are reserved. Advantech Co., Ltd. reserves the right to make improvements in the products described in this manual at any time without notice. No part of this manual may be reproduced, copied, translated, or transmitted in any form or by any means without the prior written permission of Advantech Co., Ltd. The information provided in this manual is intended to be accurate and reliable. However, Advantech Co., Ltd. assumes no responsibility for its use, nor for any infringements of the rights of third parties that may result from its use.

Acknowledgments

IBM and PC are trademarks of International Business Machines Corporation.

Intel® Pentium/Celeron/Atom J6425/J6413/N6211/x6413E is trademark of Intel Corporation.

Nuvoton is a trademark of Nuvoton Corporation.

All other product names or trademarks are properties of their respective owners.

Product Warranty (2 years)

Advantech warrants the original purchaser that each of its products will be free from defects in materials and workmanship for two years from the date of purchase.

This warranty does not apply to any products that have been repaired or altered by persons other than repair personnel authorized by Advantech, or products that have been subject to misuse, abuse, accident, or improper installation. Advantech assumes no liability under the terms of this warranty as a consequence of such events.

Because of Advantech's high quality-control standards and rigorous testing, most customers never need to use our repair service. If an Advantech product is defective, it will be repaired or replaced free of charge during the warranty period. For out-of-warranty repairs, customers will be billed according to the cost of replacement materials, service time, and freight. Please consult your dealer for more details.

If you believe your product to be defective, follow the steps outlined below.

1. Collect all the information about the problem encountered. (For example, CPU speed, Advantech products used, other hardware and software used, etc.) Note anything abnormal and list any onscreen messages displayed when the problem occurs.
2. Call your dealer and describe the problem. Please have your manual, product, and any helpful information readily available.
3. If your product is diagnosed as defective, obtain a return merchandise authorization (RMA) number from your dealer. This allows us to process your return more quickly.
4. Carefully pack the defective product, a completed Repair and Replacement Order Card, and a proof of purchase date (such as a photocopy of your sales receipt) into a shippable container. Products returned without a proof of purchase date are not eligible for warranty service.
5. Write the RMA number clearly on the outside of the package and ship the package prepaid to your dealer.

Part No.
Printed in China

Edition 2
July 2021

Message to the Customer

Advantech Customer Services

Every Advantech product is built with the most exact specifications to ensure reliable performance in the harsh and demanding conditions typical of industrial environments. Whether your new Advantech equipment is destined for a laboratory or factory floor, be assured that your product can provide the reliability and ease of operation for which the name Advantech is renowned.

Your satisfaction is our primary concern. A guide to Advantech's customer services is provided below. To ensure that you receive the full benefit of our services, please follow the instructions below.

Technical Support

We want you to get the maximum performance from your products. Should you encounter any technical difficulties, we are available to provide assistance. Answers to the most frequently asked questions are provided in the product documentation. These answers are typically a lot more detailed than the ones provided over the phone.

So please consult this manual first. If you still cannot find the answer, gather all relevant information or questions that apply to your problem, and with the product close to hand, call your dealer. Our dealers are well trained and ready to provide the support required for you to experience the most from your Advantech products. Most of the problems reported are minor and can be easily solved over the phone.

In addition, free technical support from Advantech engineers is available every business day. We are always willing to give advice on application requirements or specific information regarding the installation and operation of any of our products.

Declaration of Conformity

FCC Class B

This equipment has been tested and found to comply with the limits for a Class B digital device, pursuant to part 15 of the FCC Rules. These limits are designed to provide reasonable protection against harmful interference in a residential installation. This equipment generates, uses, and can radiate radio frequency energy and, if not installed and used in accordance with the instruction manual, may cause harmful interference to radio communications. However, there is no guarantee that interference will not occur in a particular installation. If this equipment does cause harmful interference to radio or television reception, which can be determined by turning the equipment off and on, the user is encouraged to try to correct the interference by one or more of the following measures:

- Reorient or relocate the receiving antenna.
- Increase the separation between the equipment and receiver.
- Connect the equipment into an outlet on a circuit different from that to which the receiver is connected.
- Consult the dealer or an experienced radio/TV technician for assistance.

Memory Compatibility

Category	Speed	Capacity	Vendor	Module_PN	Chip_PN	ADVANTECH P/N
DDR4	3200	16 GB	Advantech	SQR-SD4N16G3K2SNCB	SEC001 K4A8G08 5WCBCWE	SQR-SD4N16G3K2SNCB
DDR4	2666	16 GB	Advantech	AQD-SD4U16N26-SE	SEC 928 K4A8G08 5WC BCTD	AQD-SD4U16N26-SE
DDR4	2666	32 GB	Advantech	SQR-SD4N32G2K6SNME	SEC 849 K4AAG08 5WM BCTD	SQR-SD4N32G2K6SNME
DDR4	2666	8 GB	Advantech	SQR-SD4N8G2K6SNBCB	SEC 837 K4A8G08 5WC BCTD	SQR-SD4N8G2K6SNBCB
DDR4	2666	4 GB	Advantech	SQR-SD4N4G2K6SNEFB	SEC 907 K4A4G08 5WF BCTD	SQR-SD4N4G2K6SNEFB
DDR4	2400	4 GB	Advantech	SQR-SD4N4G2K4SNEFB	SEC007 K4A4G08 5WFBCTD	SQR-SD4N4G2K4SNEFB
DDR4	2133	16 GB	Advantech	AQD-SD4U16N21-SE	SEC 546 K4A8G08 5WB BCPB	AQD-SD4U16N21-SE
DDR4	2133	8 GB	Advantech	AQD-SD4U8GN21-SG	SEC 552 BCPB K4A4G085WD	AQD-SD4U8GN21-SG
DDR4	2400	16 GB	Advantech	AQD-SD4U16N24-HE	H5AN8G8NCJ	AQD-SD4U16N24-HE

Ordering Information

Part Number	CPU	Memory	LVDS/ eDP	HDMI	DP	GbE LAN	COM	SATA III	USB 3.2/2.0	M.2	TPM	AMP	PClex1	Thermal Solution	Operating Temp.
AIMB-218L-S0A1E	N6211	2	-/-	1	1	1	2	1	3/5	2	-	-	1	Passive	0 ~ 60 °C
AIMB-218LA-S0A1E	N6210	2	-/-	1	1	1	2	1	3/5	2	-	-	1	Passive	0 ~ 60 °C
AIMB-218D-S0A1E	J6426	2	1/(1)	1	1	2	6(High Speed)	1	3/5	2	1	2 x 6W	1	Passive	0 ~ 60 °C
AIMB-218J-S0A1E	J6413	2	(1)/(1)	1	1	2	2(+4)	1	3/5	2	(1)	(2 x 6W)	1	Passive	0 ~ 60 °C
AIMB-218JA-S0A1E	J6412	2	(1)/(1)	1	1	2	2(+4)	1	3/5	2	(1)	(2 x 6W)	1	Passive	0 ~ 60 °C
AIMB-218Z-S0A1E	x6413E2	2	1/(1)	1	1	2	6(High Speed)	1	3/5	2	(1)	(2 x 6W)	1	Passive	-20 ~ 70 °C

Note:

1. Passive = fanless
2. () BOM options available on MP version
3. AIMB-218L / 218LA : w/o Cables, Startup manual, M.2 Screw

Initial Inspection

Before installing the motherboard, please ensure that the following items are included in your shipment:

- 1x AIMB-218 Mini-ITX motherboard
- 1 x SATA HDD cable
- 1 x SATA power cable
- 1 x Serial port cable (1 to 4), for AIMB-218D/Z
- 1 x Serial port cable (1 to 2)
- 1 x I/O port bracket
- 1 x Startup manual
- 1 x Warranty card
- 1 x On-board CPU heat sink

If any of these items are missing or damaged, contact your distributor or sales representative immediately. All AIMB-218 devices are mechanically and electrically inspected before shipment. Thus, your product should be free of marks and scratches and in perfect working order upon receipt. While unpacking AIMB-218, check the product for signs of shipping damage (for example, a damaged box, scratches, dents, etc.). If the device is damaged or fails to meet the specifications, notify our service department or your local sales representative immediately. Please also notify the carrier. Retain the shipping carton and packing material for inspection by the carrier. After this inspection, we will make arrangements to repair or replace the unit.

Contents

Chapter 1	General Information	1
1.1	Introduction	2
1.2	Features	2
1.3	Specifications	2
1.3.1	System	2
1.3.2	Memory	2
1.3.3	Input/Output	3
1.3.4	Graphics	3
1.3.5	Ethernet LAN	3
1.3.6	Industrial Features	3
1.3.7	Mechanical and Environmental Specifications	3
1.4	Jumpers and Connectors	4
	Table 1.1: Connector / Header List	4
	Table 1.2: Jumper List	5
1.5	Board Layout: Jumper and Connector Locations	6
	Figure 1.1 Jumper and Connector Locations	6
	Figure 1.2 I/O Connectors	7
1.6	AIMB-218 Board Diagram	7
	Figure 1.3 AIMB-218 Board Diagram	7
1.7	Safety Precautions	8
1.8	Jumper Options	8
1.8.1	Setting Jumpers	8
1.8.2	CMOS Mode Selection (JCMOS1)	9
	Table 1.3: CMOS Mode Selection (JCMOS1)	9
1.8.3	COM2 RS-232/422/485 Mode Selector (JSETCOM2)	9
	Table 1.4: COM2 RS-232/422/485 Mode Selector (JSETCOM2)	9
1.8.4	eDP/LVDS Panel Voltage Selection (JLVDS1)	10
	Table 1.5: eDP/LVDS Panel Voltage Selection (JLVDS1)	10
1.8.5	PSON1: ATX and AT Mode Selector	10
	Table 1.6: PSON1: ATX and AT Mode Selector	10
1.8.6	JWDT1 + JOBS1: Watchdog Timer Output and OBS Beep	11
	Table 1.7: JWDT1 + JOBS1: Watchdog Timer Output and OBS Beep	11
1.8.7	Case Open Pin Header Selection (JCASEOP_SW1)	11
	Table 1.8: Case Open Pin Header Selection (JCASEOP_SW1)	11
1.8.8	Power Switch/HDD LED/SMBus/Speaker Pin Header (JFP1)	12
	Table 1.9: Power Switch/HDD LED/SMBus/Speaker Pin Header (JFP1)	12
1.8.9	LVDS JEIDA/VESA Selection (JLVDS_VCON1)	12
	Table 1.10: LVDS JEIDA/VESA Selection (JLVDS_VCON1)	12
1.8.10	COM1 5V/12V/RI# selection (JSETCOM1_V1)	13
	Table 1.11: COM1 5V/12V/RI# selection (JSETCOM1_V1)	13
Chapter 2	Connecting Peripherals	15
2.1	Introduction	16
2.2	DC input DC-Jack Connector (DCIN1) & 4-Pin ATX 12V Power Supply Connector (ATX12V1)	16
2.3	HDMI & DisplayPort Connector (DP1+HDMI1)	16
2.4	USB Connector (USB12/USB34/USB56/USB78)	17
2.5	LAN Ports	17
2.6	Front HD Analog Audio Interface (FPAUD1)	18
2.7	HD Analog Audio Interface Line-Out (AUDIO1)	18

2.8	HD Digital Audio Interface (SPDIF1).....	19
2.9	Audio Amplifier Output Connector (AMP1) BOM optional	19
2.10	PCI Express X1 Slot (PCIEX1_1)	20
2.11	NGFF M.2 E-Key connector for 2230 module (M2E1).....	20
2.12	NGFF M.2 B-Key connector for 2242/2280/3042 module (M2B1).....	21
2.13	SATA Signal Connector (SATA1) & SATA Power Connector (SATA_PWR1).....	21
2.14	Serial Ports (COM1 ~ COM6)	22
	2.14.1 COM 2 Port (COM12).....	22
	2.14.2 COM Port (COM3456).....	22
2.15	SIM Card Connector (SIM1)	23
2.16	SPI Programming Pin Header (SPI_CN1)	23
2.17	SPI BIOS Flash Socket (SPI1).....	24
2.18	ESPI Pin Header (ESPI1)	24
2.19	8-bits General Purpose I/O Pin Header (GPIO1).....	25
2.20	Low-voltage differential signaling interface & Embedded displayport (LVDS_EDP1).....	25
2.21	LVDS Backlight Inverter Power Connector (INV1).....	26
2.22	SYSTEM FAN Power Connector (SYSFAN1)	26
2.23	DDR4 SO-DIMM Socket (DIMMA1/DIMMB1).....	27
2.24	ATX Power supply (5VSB) connector (ATX_5VSB1)	27
2.25	Front Panel Connectors (JFP1)	28
	2.25.1 ATX Soft Power Switch (JFP1/PWR_SW).....	28
	2.25.2 Reset (JFP1/RESET).....	28
	2.25.3 HDD LED (JFP1/HDDLED)	28
	2.25.4 External Speaker (JFP1/SPEAKER)	28

Chapter 3 BIOS Operation 29

3.1	Introduction	30
3.2	BIOS Setup	30
	3.2.1 Main Menu	31
	3.2.2 Advanced BIOS Features	32
3.3	Chipset Configuration Setting	50
	3.3.1 System Agent (SA) Configuration.....	51
	3.3.2 PCH-IO Configuration.....	55
3.4	Security Setting.....	62
3.5	Boot Setting	63
3.6	Save & Exit Configuration	64

Chapter 4 Software and Service Introduction.. 67

4.1	Introduction	68
4.2	Value-Added Software Services	68
	4.2.1 Software API.....	68
	4.2.2 Software Utility.....	70

Chapter 5 Chipset Software Install Utility 71

5.1	Before Installation	72
5.2	Introduction	72

Chapter 6 Graphics Setup 73

6.1	Introduction	74
6.2	Windows 10	74

Chapter 7 LAN Configuration.....75

7.1	Introduction	76
7.2	Features	76
7.3	Installation	76
7.4	Windows 10 Driver Setup (Realtek 8111G)	76

Appendix A Pin Assignments77

A.1	DC Input Phoenix Connector (DCIN1)	78
A.2	Definition Multimedia Interface (DP1+HDMI1)	78
A.3	USB 3.0+2.0 Stack Connector (USB34)	79
A.4	USB 3.0 Stack Connector (USB34)	79
A.5	RJ45 1 Port (LAN1).....	80
A.6	RJ45 2 Port (LAN12).....	81
A.7	Front HD Analog Audio Interface (FPAUD1).....	81
A.8	HD Analog Audio Interface Line-Out (AUDIO1)	82
A.9	HD Digital Audio Interface (SPDIF1).....	82
A.10	Audio Amplifier Output Connector (AMP1)	82
A.11	PCI Express X1 Slot (PCIEX1_1)	83
A.12	NGFF M.2 E-Key Connector for 2230 Module (M2E1)	84
A.13	SATA Signal Connector (SATA1)	85
A.14	NGFF M.2 B-Key Connector for 2242/2280/3042 Module (M2B1)	86
A.15	USB 2.0 Pin Header (USB56)	87
A.16	COM Port (COM3456)	88
A.17	SIM Card Connector (SIM1).....	89
A.18	SPI Programming Pin Header (SPI_CN1)	89
A.19	SPI BIOS Flash Socket (SPI1).....	90
A.20	USB 2.0 Pin Header (USB78)	90
A.21	ESPI Pin Header (ESPI1)	90
A.22	8-bit General Purpose I/O Pin Header (GPIO1).....	91
A.23	Case-Open Detect Connector (JCASE1).....	91
A.24	COM Port (COM12)	91
A.25	Power LED Pin Header (JFP2)	92
A.26	LVDS Backlight Inverter Power Connector (INV1).....	92
A.27	SATA Power Connector (SATA_PWR1).....	92
A.28	SYSTEM FAN Power Connector (SYSFAN1).....	93
A.29	MPS's I2C/SMBUS Programming for +VCCIN Controller (JSMB1).....	93
A.30	Low-Voltage Differential Signaling Interface (LVDS_EDP1).....	94
A.31	Embedded Displayport (LVDS_EDP1).....	95
A.32	ATX Power Supply (5VSB) Connector (ATX_5VSB1)	95
A.33	ATX 12V Power Supply Connector (ATX12V1)	96

Chapter 1

General Information

1.1 Introduction

The AIMB-218 with Intel Pentium J6426, Celeron J6412/J6413, Celeron N6210/N6211, and Atom x6413E processor is designed for industrial applications that require enhanced computing performance and power management capabilities. The motherboard features an onboard Intel® Pentium™ J6426 quad-core 1.8 GHz, Celeron J6413 quad-core 2.0 GHz, Celeron J6412 quad-core 2.0 GHz, Celeron N6211 dual-core 1.2 GHz, Celeron N6210 dual-core 1.2 GHz and Atom x6413E quad-core 1.5 GHz with DDR4 3200 MHz up to 32GB.

The AIMB-218 offers rich I/O connectivity with three USB 3.2 Gen2 and five USB 2.0 ports, as well as 6 x COM ports integrated in a standard 170 x 170 mm form factor. The system also supports triple displays for HDMI, DP++, LVDS (or eDP). AIMB-218 also features numerous connectivity and expansion options, including PCIe x1, 8-bit GPIO, SATA III 6 GB/s connectors, an optional TPM security feature, and two M.2 (E key for 2230 type, B Key for 2242/3042/2280 type) expansion slots for easy integration. A dual Realtek chipset and 10/100/1000 Mbps Ethernet port are also provided to deliver high-speed networking.

AIMB-218 is powered by the newest Intel® Pentium/Celeron/Atom processor, which is built on 14nm process technology. And latest Intel Gen 11 graphic engines with up to 32EU provide extreme high display resolution. The thermal design power rating for the Intel N6211 dual-core architecture is only 6.5W, and that for J6413/J6425/x6413E quad-core is 10 W, allowing additional power reductions and performance improvements to be implemented in the future. All the features described above are incorporated into a space-saving, power-efficient, and cost-effective Mini-ITX form factor.

1.2 Features

- Supports Intel® Pentium J6426, Celeron J6412/J6413, Celeron N6210/N6211, and Atom x6413E processors
- Two 260-pin SODIMM, up to 32 GB DDR4 3200 MHz SDRAM
- Supports 1 x PCIe x1, and 2 x M.2 (B/E key) expansion ports, six serial ports, 3 x USB 3.2 Gen2 & 5 x USB 2.0 and 1 x SATAIII ports
- Lower total ownership costs with DC12V functionality; supports triple displays of HDMI, DP++, LVDS (or eDP)
- Onboard TPM 2.0 support (optional)
- Supports a dual-channel 6W amplifier (optional)
- Supports embedded software APIs and utilities

1.3 Specifications

1.3.1 System

- **CPU:** Intel® Pentium J6426, Celeron J6412/J6413, Celeron N6210/N6211, and Atom x6413E processors
- **BIOS:** SPI 256-Mbit BIOS
- **SATA hard disk drive interface:** onboard SATA connectors with a data transmission rate of up to 6 Gb/s

1.3.2 Memory

- **RAM:** 2 x SO-DIMM DDR4 3200 MHz up to 32 GB

1.3.3 Input/Output

- **PCI bus:** One PCIe x1 slot, one M.2 2242/3042/2280 (B Key) and one M.2 2230 (E key) socket
- **Serial ports:** Six serial ports; COM1 support 5V/12V selection; COM2 support RS-232/422/485, set by Jumper; COM3~COM6 support RS-232 (COM3~6 BOM option)
- **USB port:** Supports three USB 3.2 Gen2 port with a transmission rates of up to 10Gbps and five USB 2.0 ports with transmission rates of up to 480 Mbps. Noticed: USB power current delivery under S5 Max. 1.8A
- **GPIO connector:** One 8-bit general purpose input/output

1.3.4 Graphics

- **Controller:** Embedded Gen11
- **HDMI:** Supports a display resolution of up to 3840 x 2160 @ 60 Hz
- **DP++:** Supports a display resolution up to 4096 x 2160 @ 60 Hz
- **LVDS:** Supports up to 1920 x 1200 @ 60 Hz, colay eDP
- **eDP:** Supports up to 4096 x 2160 @ 60 Hz, colay LVDS and eDP is BOM optional

1.3.5 Ethernet LAN

- Supports dual 10/100/1000 Mbps Ethernet port (s) via PCI Express x1 bus, which provides a data transmission rate of 500 MB/s
- **Controller:** LAN1: Realtek 8111H; LAN2: Realtek 8111H

1.3.6 Industrial Features

- **Watchdog timer:** Can generate a system reset. The watchdog timer is programmable, with each unit equal to one second or one minute (255 levels)

1.3.7 Mechanical and Environmental Specifications

- **Operating temperature:** 0 ~ 60 °C (32 ~ 140 °F, depending on the CPU)
- **Storage temperature:** -40 ~ 85 °C (-40 ~ 185 °F)
- **Humidity:** 5 ~ 95% non-condensing
- **Power supply voltage:** +12 V
- **Power consumption:**+12 V @ 1.84 A (Intel J6425 1.8 GHz processor/DDR4 3200 MHz 32 GB x 2)
- **Board size:** 170 x 170 mm (6.69 x 6.69")
- **Board weight:** 0.365 kg

1.4 Jumpers and Connectors

Connectors on the AIMB-218 motherboard link it to external devices such as hard disk drives. In addition, the board has a number of jumpers used to configure your system for your application.

The tables below list the function of each of the board jumpers and connectors. Later sections in this chapter give instructions on setting jumpers. Chapter 2 gives instructions for connecting external devices to your motherboard.

Table 1.1: Connector / Header List

	Description	Part Reference
1	DC input Phoenix Connector	DCIN1
2	DisplayPort	DP1+HDMI1
3	High Definition Multimedia Interface	DP1+HDMI1
4	USB 3.0+2.0 Stack Connector	USB34
5	Elkhart Lake CPU BGA	CPU1
6	USB 3.1 Stack Connector	USB12
7	RJ45 1 port	LAN1
8	RJ45 2 port	LAN12
9	Front HD Analog Audio Interface	FPAUD1
10	HD Analog Audio Interface Line-Out	AUDIO1
11	HD Analog Audio Interface MIC-In	AUDIO2
12	HD Digital Audio Interface	SPDIF1
13	Audio Amplifier Output Connector	AMP1
14	PCI Express X1 Slot	PCIEX1_1
15	NGFF M.2 E-Key connector for 2230 module	M2E1
16	SATA Signal Connector	SATA1
17	NGFF M.2 B-Key connector for 2242/3042 module	M2B1
18	USB 2.0 Connector	USB56
19	COM Port	COM3456
20	SIM Card Connector	SIM1
21	SPI Programming Pin Header	SPI_CN1
22	SPI BIOS Flash Socket	SPI1
23	LED_PORT80 Pin Header	LED_PORT80
24	USB 2.0 Connector	USB78
25	ESPI Pin Header	ESPI1
26	8-bits General Purpose I/O Pin Header	GPIO1
27	Battery Wafer Box	BAT1
28	Case-Open Detect Connector	JCASE1
29	COM Port	COM12

Table 1.1: Connector / Header List

30	Buzzer	U27
31	Power LED Pin Header	JFP2
32	eDP/LVDS Backlight Inverter Power Connector	INV1
33	SATA Power Connector	SATA_PWR1
34	SYSTEM FAN Power Connector	SYSFAN1
35	DDR4 SO-DIMM Socket	DIMMA1
36	DDR4 SO-DIMM Socket	DIMMB1
37	MPS's I2C/SMBUS Programming for +VCCIN Controller	JSMB1
38	eDP/LVDS Panel Connector	LVDS_EDP1
39	ATX Power supply (5VSB) connector	ATX_5VSB1
40	ATX 12V Power Supply Connector	ATX12V1
41	CPU Heat Sink Back Plate	HS1

Table 1.2: Jumper List

	Description	Part Reference
1	Case open selection pin header	JCASEOP_SW1
2	COM2 RS232/485 Selection Jumper	JSETCOM2
3	Watchdog Timer Output and OBS Beep	JWDT1+JOBS1
4	COM1 RI# pin RI#/5V/12V Select	JSETCOM1_V1
5	Power Switch/HDD LED/SMBUS/Speaker Pin Header	JFP1
6	ATX/AT Mode Selection	PERSON1
7	CMOS Clear Jumper	JCMOS1
8	LVDS VESA, JEIDA format selection pin header	JLVDS_VCON1
9	eDP/LVDS Panel Voltage Selection	JLVDS1

1.5 Board Layout: Jumper and Connector Locations

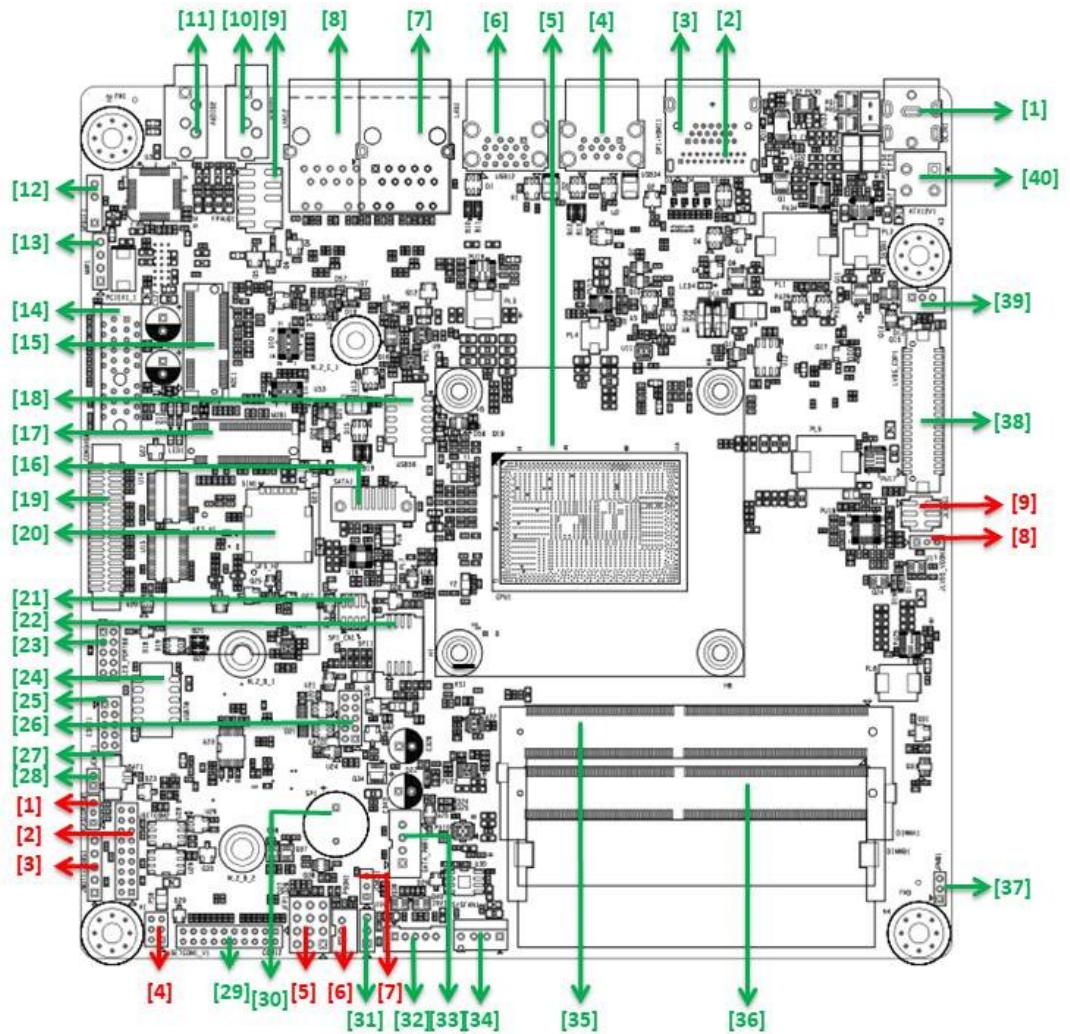

Figure 1.1 Jumper and Connector Locations

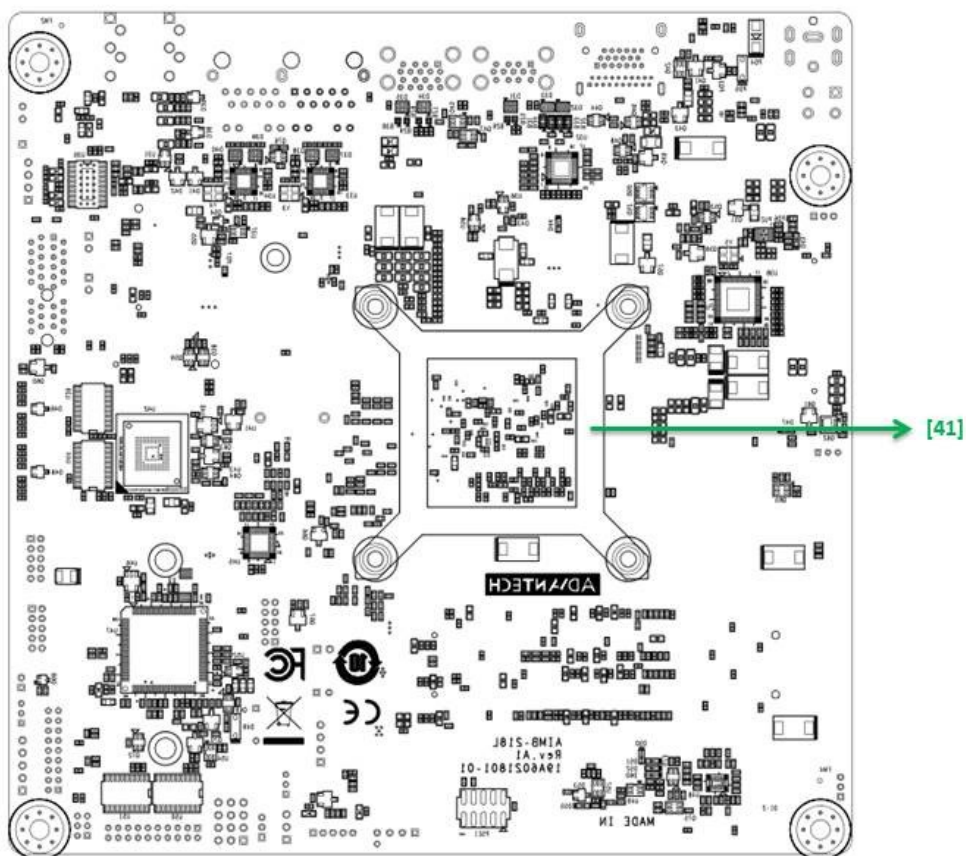

Figure 1.2 I/O Connectors

1.6 AIMB-218 Board Diagram

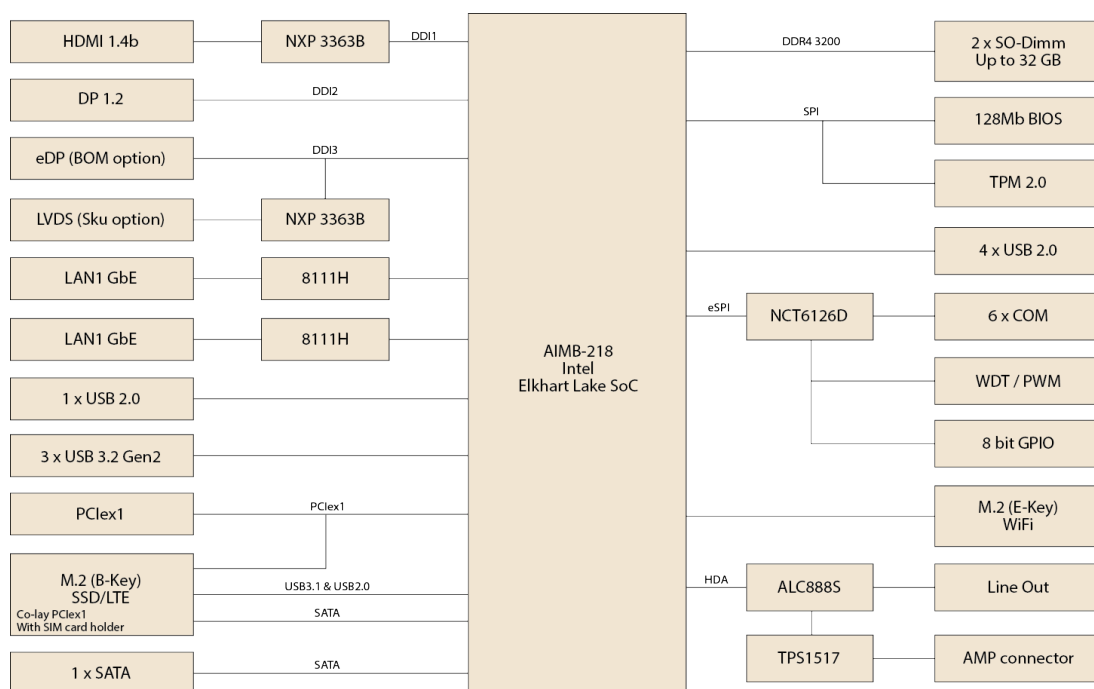

Figure 1.3 AIMB-218 Board Diagram

1.7 Safety Precautions

Warning! *Always completely disconnect the power cord from the chassis when working with the hardware. Do not connect devices while the power is on. Sensitive electronic components can be damaged by sudden power surges. Only experienced electronics personnel should open the PC chassis.*



Caution! *Always ground yourself to remove any static charge before touching the motherboard. Modern electronic devices are very sensitive to electrostatic discharges. As a safety precaution, use a grounding wrist strap at all times. Place all electronic components on a static-dissipative surface or in a static-shielded bag when not in the chassis.*



Caution! *The computer is provided with a battery-powered real-time clock circuit. There is a danger of explosion if the battery is incorrectly replaced. Replace only with the same or equivalent type recommended by the manufacturer. Discard used batteries according to the manufacturer's instructions.*



Caution! *There is a danger of a new battery exploding if incorrectly installed. Do not attempt to recharge, force open, or heat the battery. Replace the battery only with the same or equivalent type recommended by the manufacturer. Discard used batteries according to the manufacturer's instructions.*



1.8 Jumper Options

This section provides instructions on how to configure the motherboard by setting jumpers, and also outlines the default motherboard settings and options for each jumper.

1.8.1 Setting Jumpers

The motherboard can be configured according to the application requirements with the setting of jumpers. A jumper is a metal bridge used to close an electrical circuit. Jumpers typically consist of two metal pins and a small metal clip (often protected by a plastic cover) that slides over the pins to connect them. To “close” (or turn ON) a jumper, connect the pins with the clip. To “open” (or turn OFF) a jumper, simply remove the clip. Some jumpers comprise a set of three pins, labeled 1, 2, and 3. With these jumpers, simply connect either Pins 1 and 2, or Pins 2 and 3. A pair of needle-nose pliers may be necessary for setting jumpers.

1.8.2 CMOS Mode Selection (JCMOS1)

The AIMB-218 motherboard contains a jumper that can erase CMOS data and reset the system BIOS information. To reset the CMOS data, Put jumper to Pins 2 & 3 as closed for a few seconds. This procedure resets the CMOS to its default settings.

Table 1.3: CMOS Mode Selection (JCMOS1)

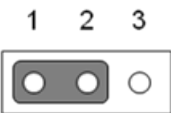
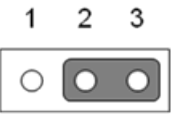
Function	Jumper Setting
Keep COMS Data (Default)	
Clear CMOS Date	

1.8.3 COM2 RS-232/422/485 Mode Selector (JSETCOM2)

Users can select between the RS-232/422/485 modes for COM2 using JSETCOM2. The default setting is “RS-232”.

Table 1.4: COM2 RS-232/422/485 Mode Selector (JSETCOM2)

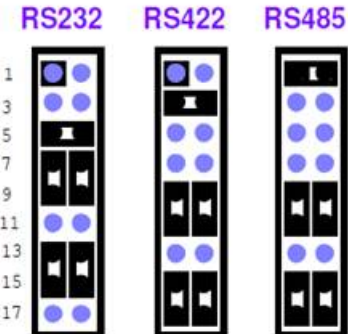
Function	Jumper Setting
(Default RS232)	

1.8.4 eDP/LVDS Panel Voltage Selection (JLVDS1)

Table 1.5: eDP/LVDS Panel Voltage Selection (JLVDS1)

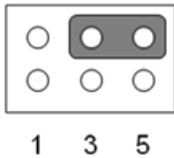
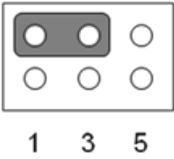
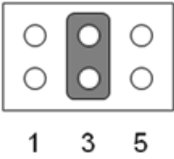
Function	Jumper Setting
Jumper position for +3.3V (Default)	
Jumper position for +5V	
Jumper position for +12V	

1.8.5 PSON1: ATX and AT Mode Selector

Table 1.6: PSON1: ATX and AT Mode Selector

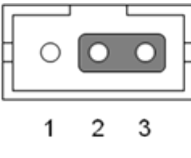
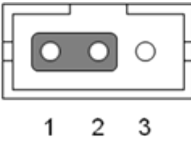
Function	Jumper Setting
ATX Mode (Default)	
ATX Mode	

1.8.6 JWDT1 + JOBS1: Watchdog Timer Output and OBS Beep

Table 1.7: JWDT1 + JOBS1: Watchdog Timer Output and OBS Beep

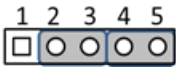
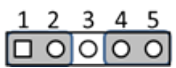
Function	Jumper Setting
Watchdog Timer Output (2-3) (Default) OBS BEEP (4-5) (Default)	 (4 and 6)+(8 and 9)
Watchdog Timer Disable (1-2) OBS BEEP (4-5) (Default)	 (1 and 2)+(8 and 9)
Pin	Signal Pin Definition
1	N/C
2	Watch dog reset# output
3	System reset input#
4	SIO Warning Beep output
5	SP1 Buzzer Beep input

1.8.7 Case Open Pin Header Selection (JCASEOP_SW1)

Table 1.8: Case Open Pin Header Selection (JCASEOP_SW1)

Function	Jumper Settings
(Default)	 1 3
Pin	Signal Pin Definition
1	Normal Open
2	Advantech define
3	Normal Close

1.8.8 Power Switch/HDD LED/SMBus/Speaker Pin Header (JFP1)

Table 1.9: Power Switch/HDD LED/SMBus/Speaker Pin Header (JFP1)

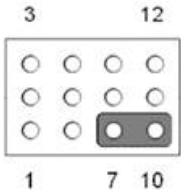
Function	Jumper Settings			
Internal Buzzer(7-10) (Default)				
Pin	Signal Pin Definition	Pin	Signal Pin Definition	
1	+5V	2	HDDLED+	
3	Power Button+	4	N/C	
5	HDDLED-	6	Power Button-	
7	SPK_P3	8	SMB_DATA	
9	System Reset+	10	SPK_P4	
11	SMB_CLK	12	System Reset-	

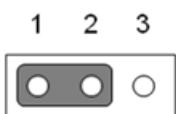
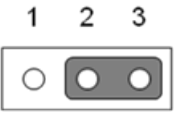

1.8.9 LVDS JEIDA/VESA Selection (JLVDS_VCON1)

Table 1.10: LVDS JEIDA/VESA Selection (JLVDS_VCON1)

Function	Jumper Settings
JEIDA mode Setting : +V3.3	
VESA mode Setting : GND (Default)	
Pin	Signal Pin Definition
1	+3.3V
2	OPTION
3	GND

1.8.10 COM1 5V/12V/RI# selection (JSETCOM1_V1)

Table 1.11: COM1 5V/12V/RI# selection (JSETCOM1_V1)

Function	Jumper Settings
Jumper position for RI# (Default)	<div style="text-align: center;"> <p>2 4 6</p>  <p>1 3 5</p> </div>
Jumper position for +5V	<div style="text-align: center;"> <p>2 4 6</p>  <p>1 3 5</p> </div>
Jumper position for +12V	<div style="text-align: center;"> <p>2 4 6</p>  <p>1 3 5</p> </div>

Pin	Signal Pin Definition	Pin	Signal Pin Definition
1	RI# [1]	2	Advantech define
3	Advantech define	4	+5V
5	+12V	6	Advantech define

Chapter 2

Connecting
Peripherals

2.1 Introduction

Most of the device connectors can be accessed from the top of the board during installation in the chassis. If the system is installed with several cards or the chassis is packed, partial removal of the card may be necessary to make all connections.

2.2 DC input DC-Jack Connector (DCIN1) & 4-Pin ATX 12V Power Supply Connector (ATX12V1)

This connector is for an ATX Micro-Fit power supply. The plugs from the power supply are designed to fit these connectors in only one direction. Determine the correct orientation and press firmly until the connectors mate completely.

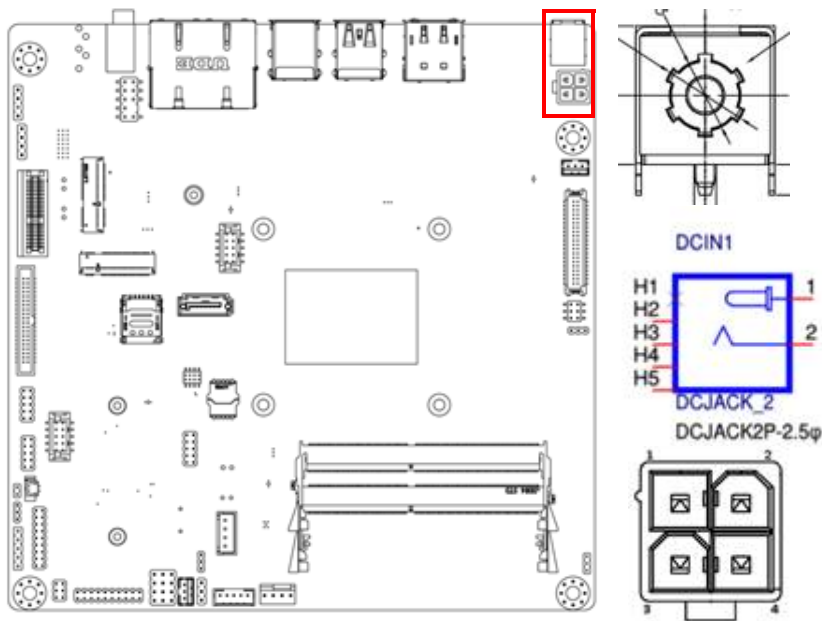

2.3 HDMI & DisplayPort Connector (DP1+HDMI1)

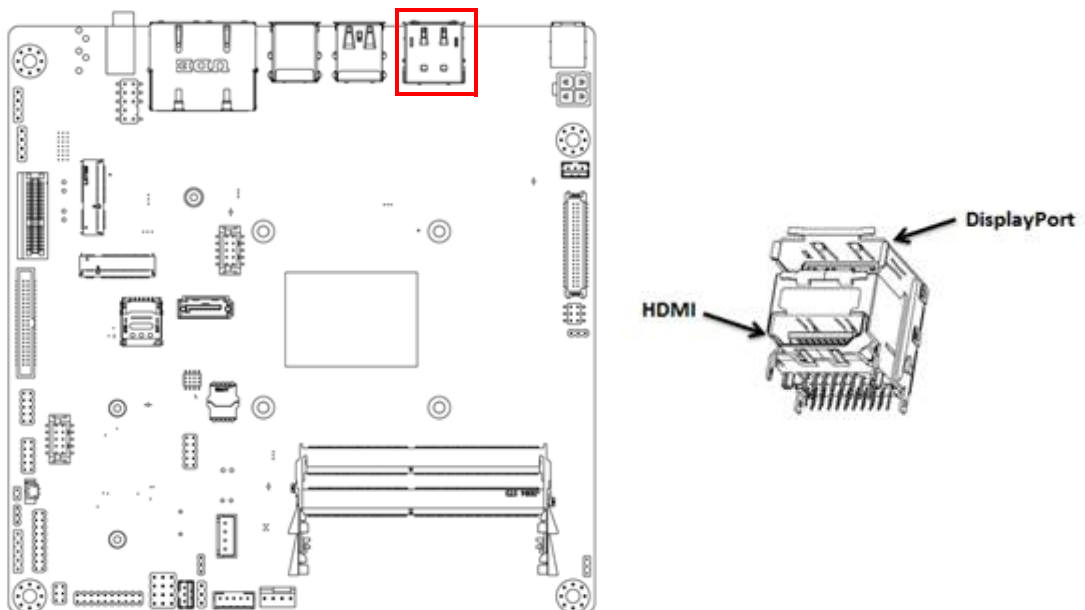

2.4 USB Connector (USB12/USB34/USB56/USB78)

AIMB-218 provides up to three USB 3.2 Gen2 and five USB 2.0 ports. (USB12/USB34/USB56/USB78. Four USB are located on the rear side, and four USB 2.0 are located internally. The USB interface complies with the USB specification revision 2.0 that supports transmission rates of up to 480 Mbps, revision 3.2 Gen2 that supports transmission rates of up to 10 Gbps, and is also fuse protected. Furthermore, the USB interface can be disabled in the system BIOS setup menu.

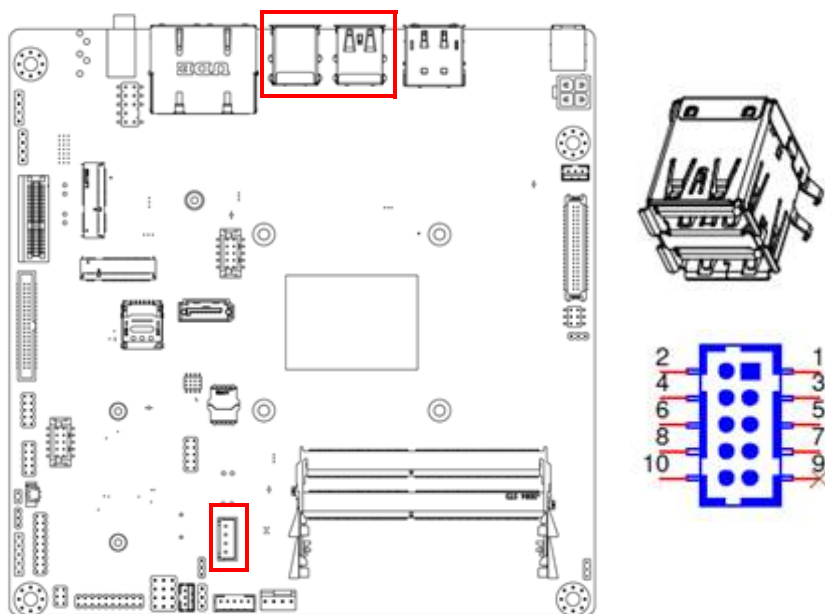

2.5 LAN Ports

The AIMB-218 system is equipped with two high-performance 1000 Mbps Ethernet LAN adapters, both of which are supported by all major network operating systems. The RJ-45 jacks on the rear panel facilitate convenient LAN connection.

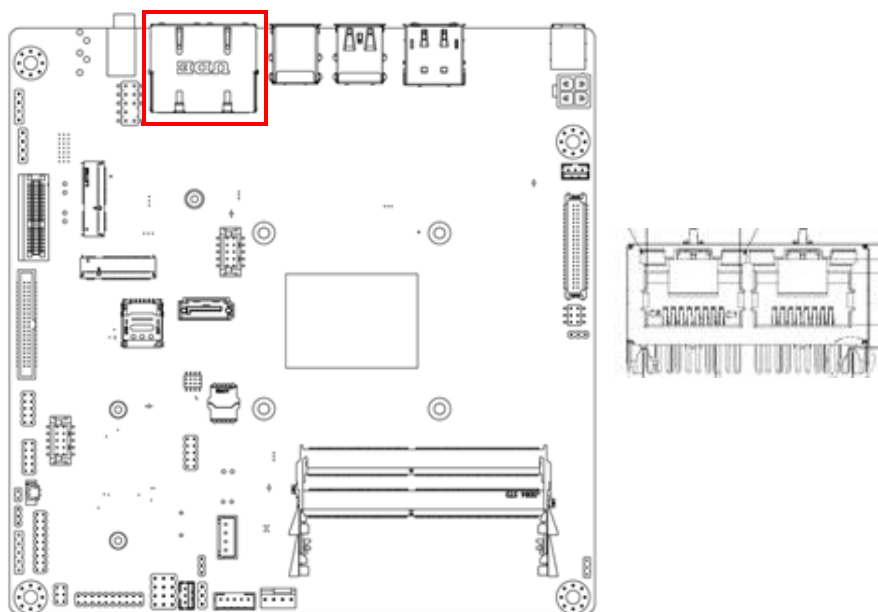

2.6 Front HD Analog Audio Interface (FPAUD1)

This connector is for a chassis-mounted front-panel audio I/O module that supports HD audio. This connector is attached using the front panel audio I/O module cable.

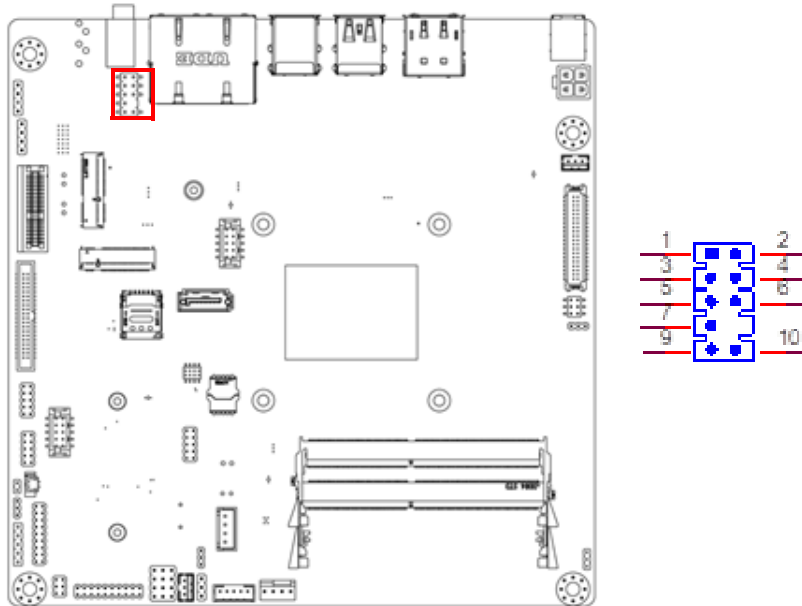

2.7 HD Analog Audio Interface Line-Out (AUDIO1)

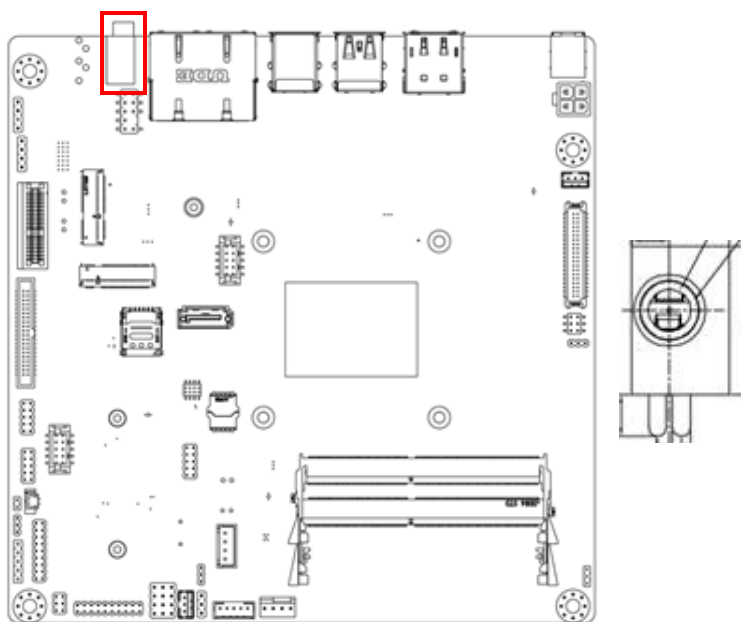

2.8 HD Digital Audio Interface (SPDIF1)

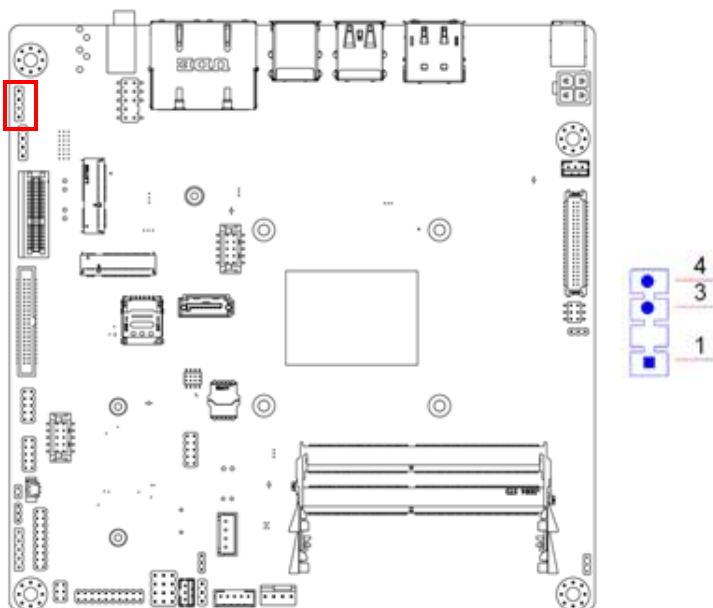

2.9 Audio Amplifier Output Connector (AMP1) BOM optional

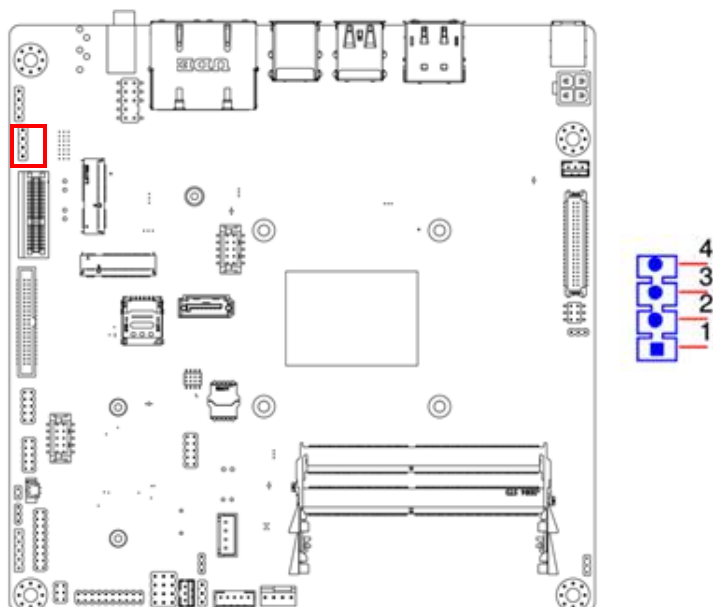

2.10 PCI Express X1 Slot (PCIEX1_1)

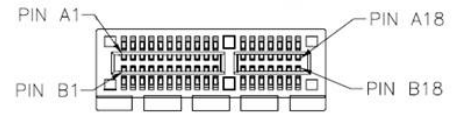
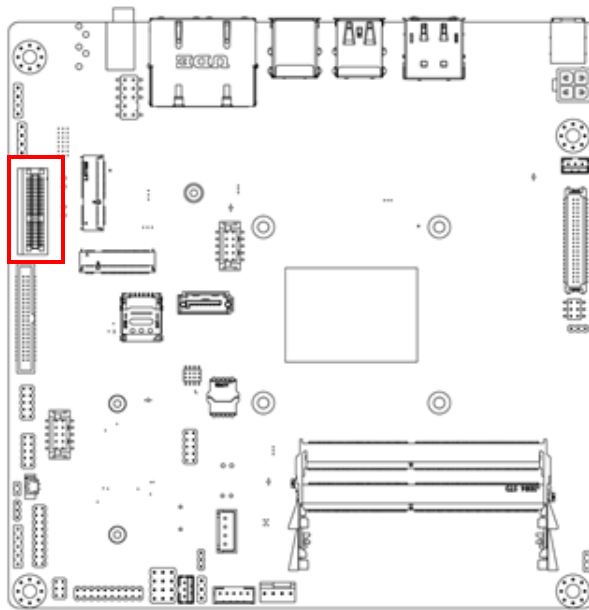

2.11 NGFF M.2 E-Key connector for 2230 module (M2E1)

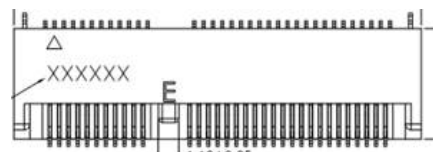
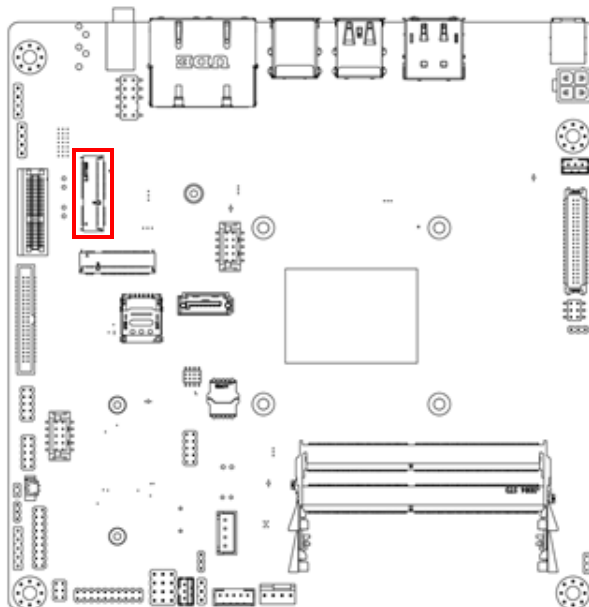

2.12 NGFF M.2 B-Key connector for 2242/2280/3042 module (M2B1)

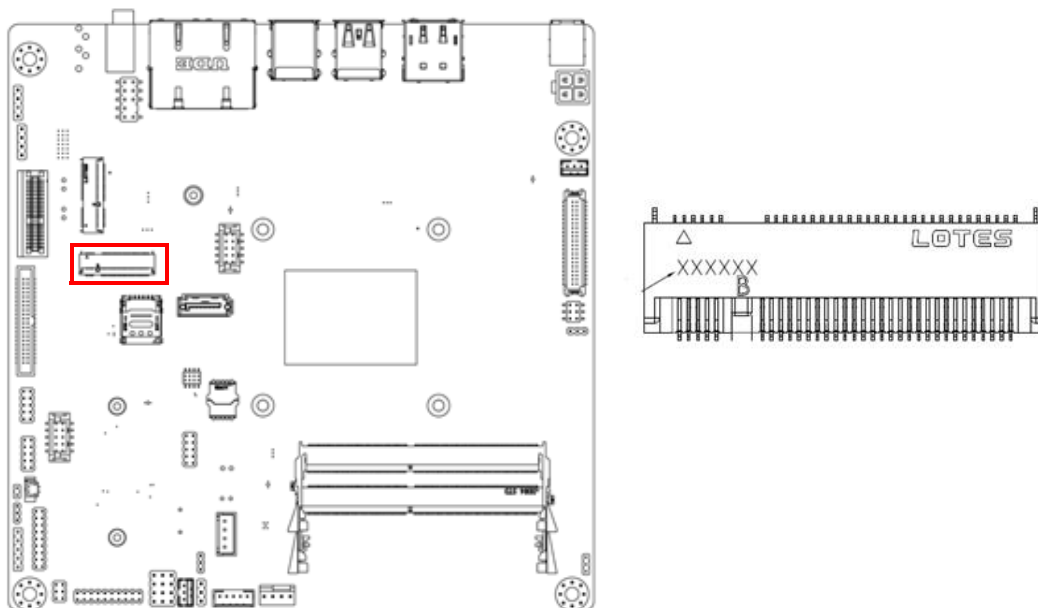

2.13 SATA Signal Connector (SATA1) & SATA Power Connector (SATA_PWR1)

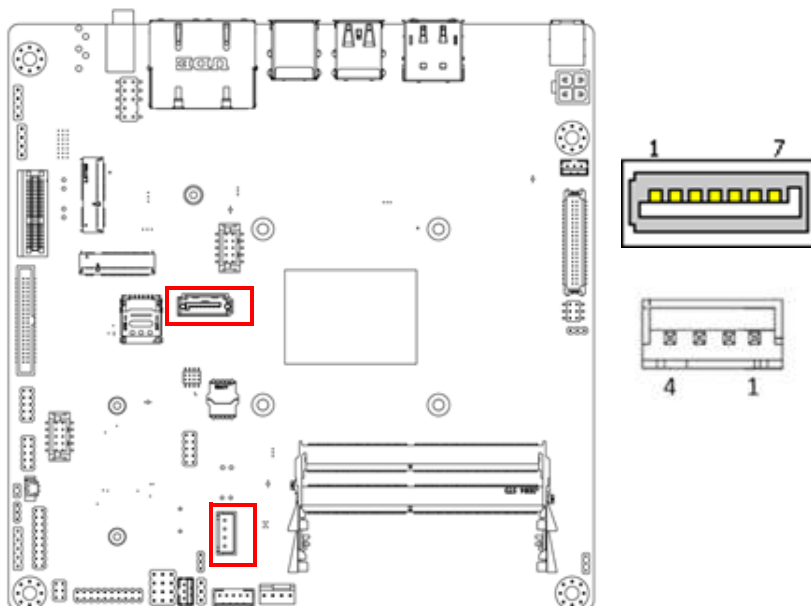

2.14 Serial Ports (COM1 ~ COM6)

AIMB-218 supports six serial ports. COM2 is RS-232/422/485 and COM1/3/4/5/6 are RS-232. COM1 also supports 5 V/12 V according to jumper selection. Users can employ JSETCOM2 to select between the RS-232/422/485 modes for COM2. Such ports can be connected to serial devices, such as a mouse or printer, or to a communications network. The IRQ and address ranges for both ports are fixed. However, users can disable the port or change the parameters via the system BIOS setup. Various devices implement the RS-232/422/485 standards in different manners. Users who experience problems with a serial device are advised check the connector pin assignments.

2.14.1 COM 2 Port (COM12)

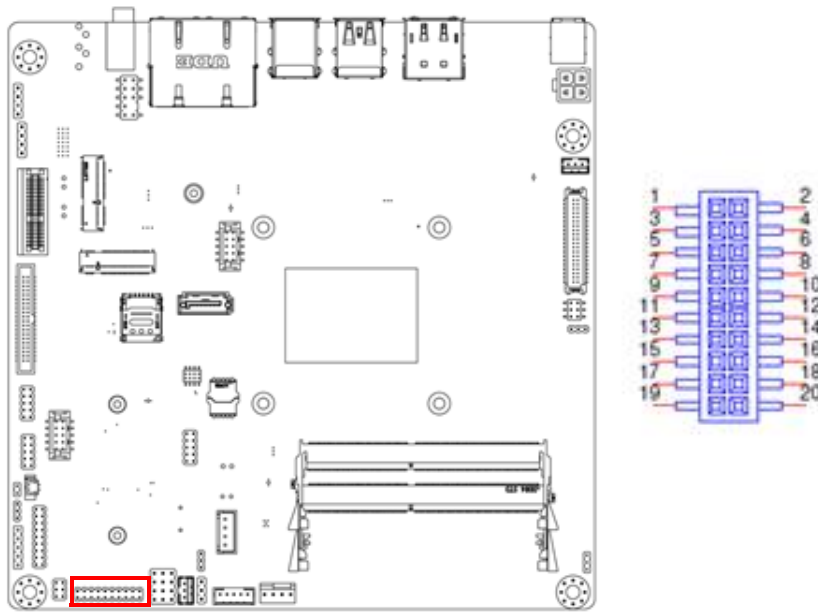

2.14.2 COM Port (COM3456)

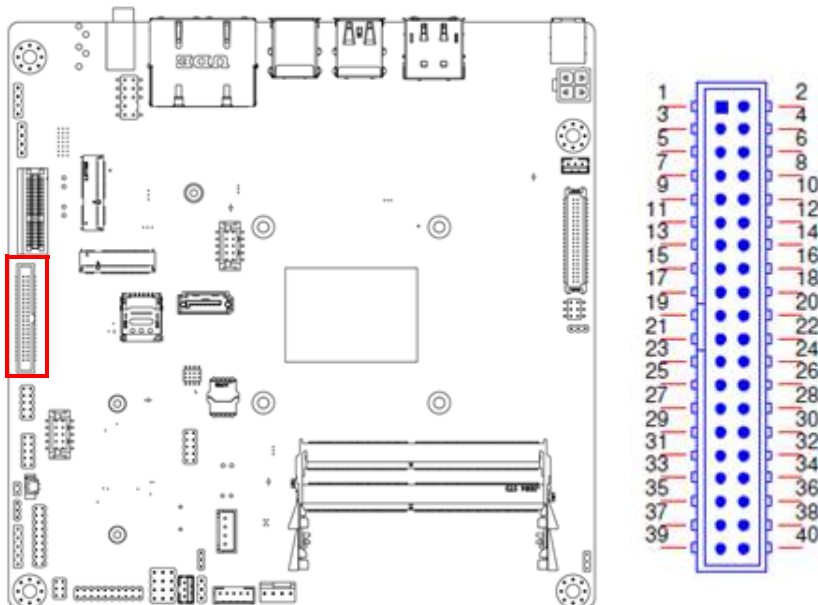

2.15 SIM Card Connector (SIM1)

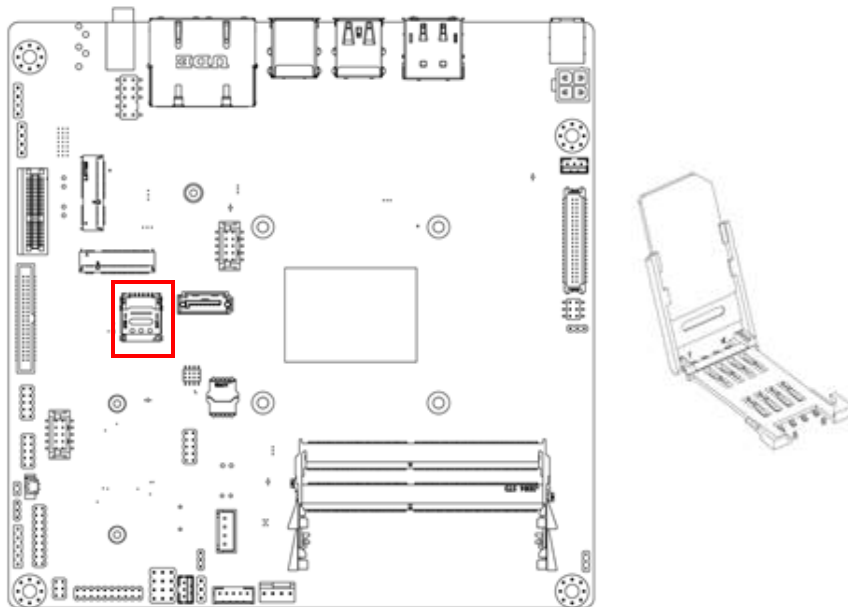

2.16 SPI Programming Pin Header (SPI_CN1)

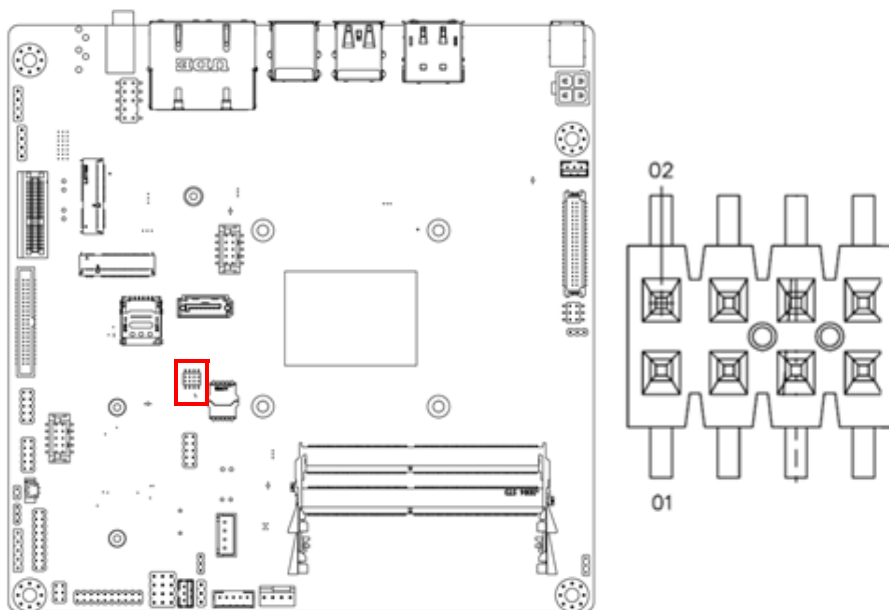

2.17 SPI BIOS Flash Socket (SPI1)

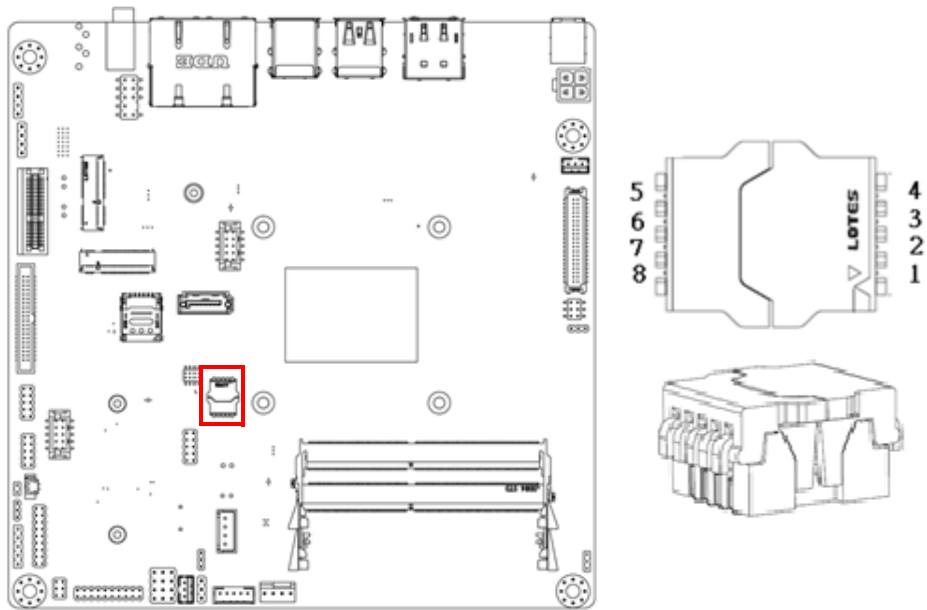

2.18 ESPI Pin Header (ESPI1)

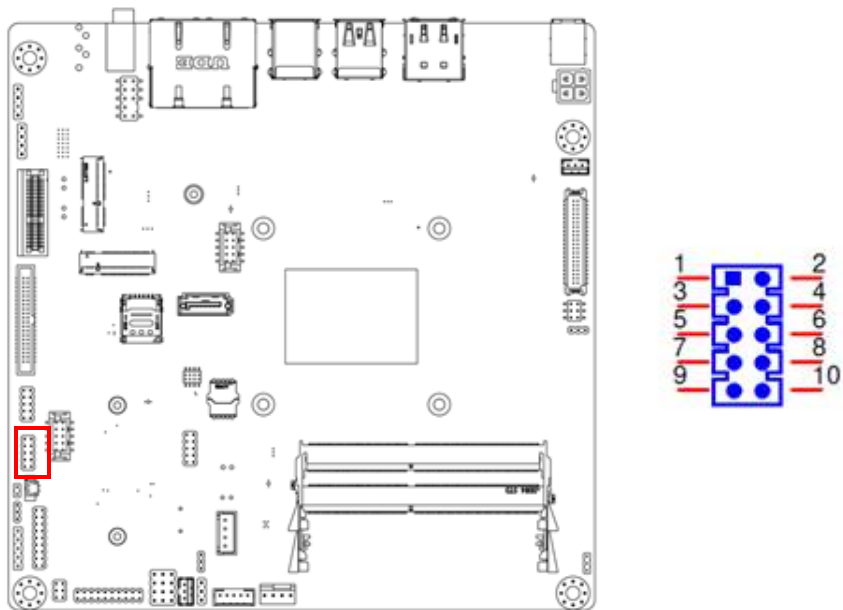

2.19 8-bits General Purpose I/O Pin Header (GPIO1)

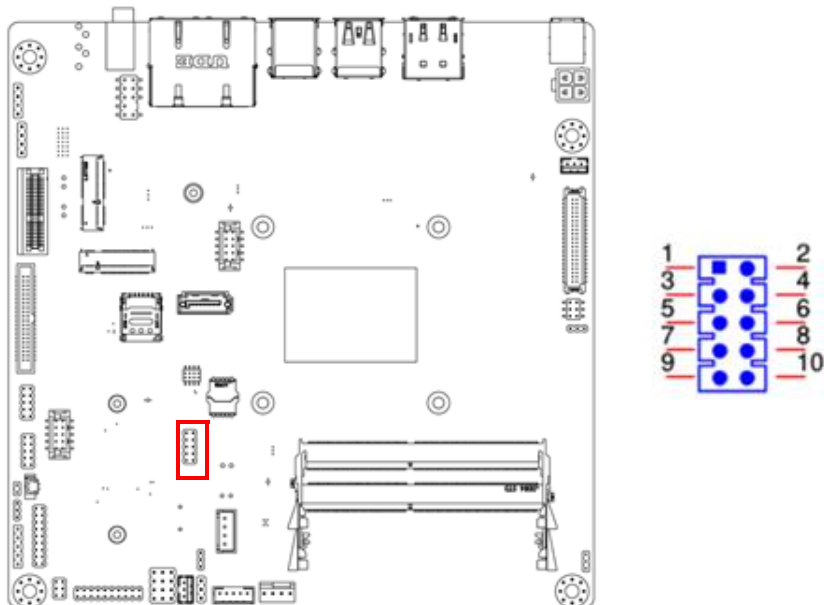

2.20 Low-voltage differential signaling interface & Embedded displayport (LVDS_EDP1)

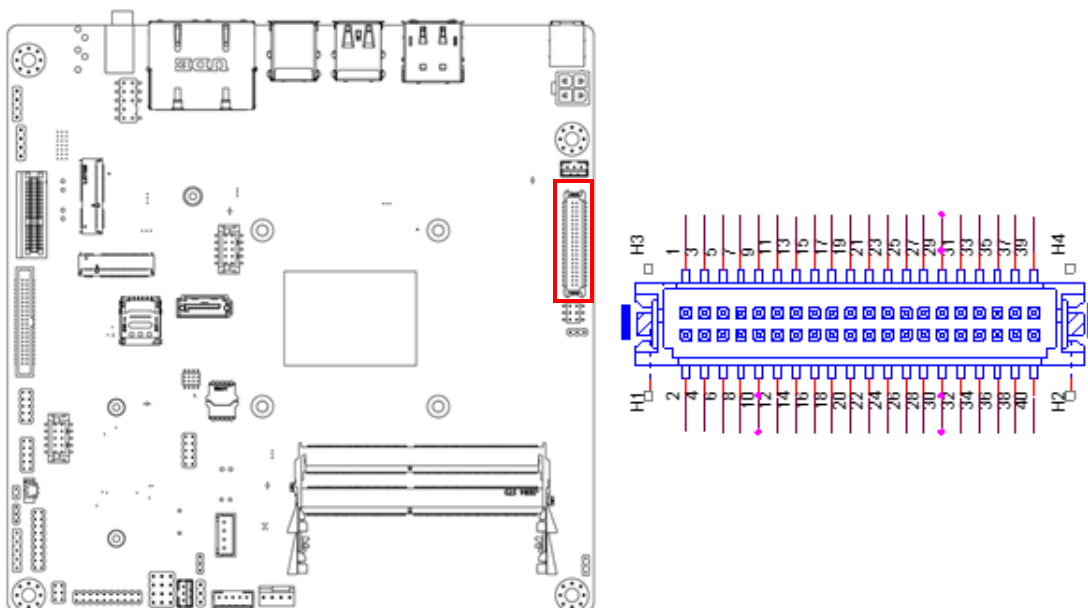

2.21 LVDS Backlight Inverter Power Connector (INV1)

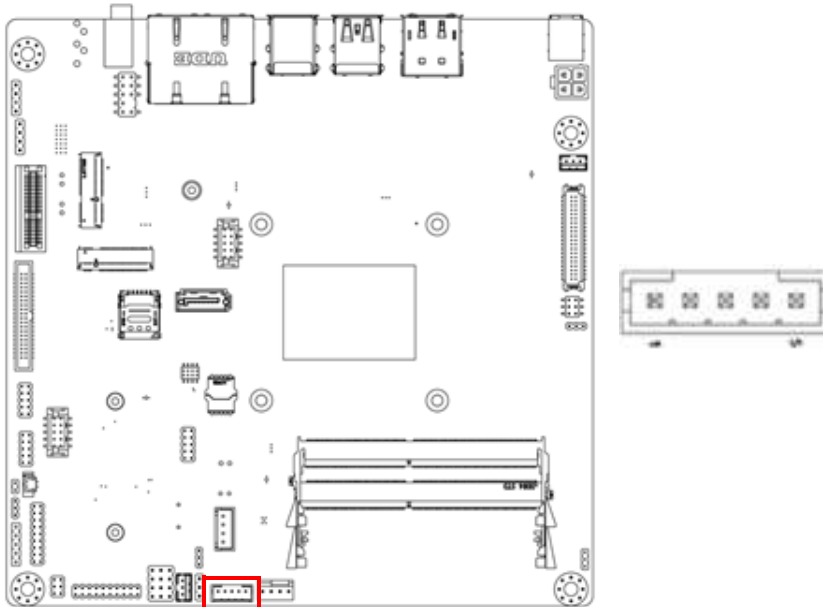

2.22 SYSTEM FAN Power Connector (SYSFAN1)

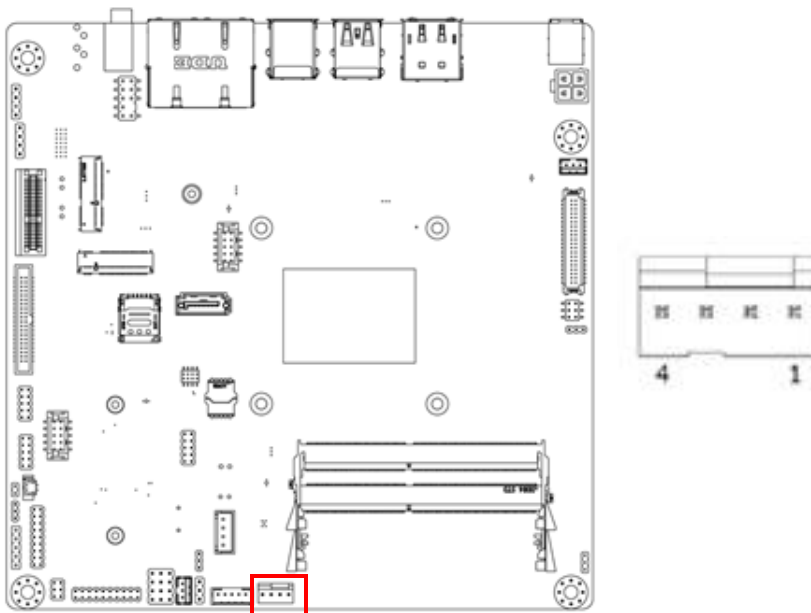

2.23 DDR4 SO-DIMM Socket (DIMMA1/DIMMB1)

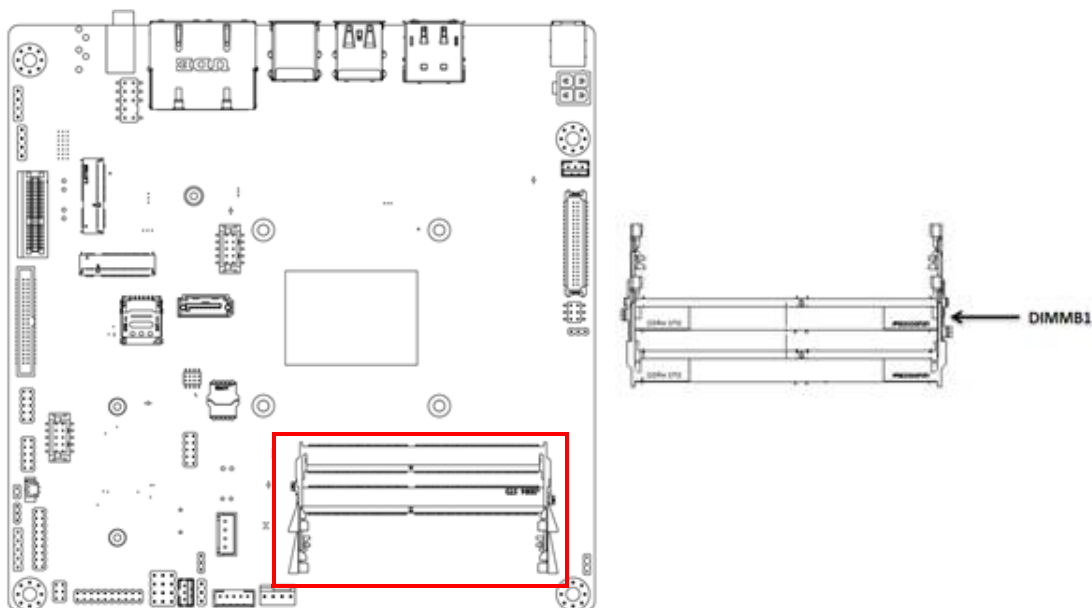

2.24 ATX Power supply (5VSB) connector (ATX_5VSB1)

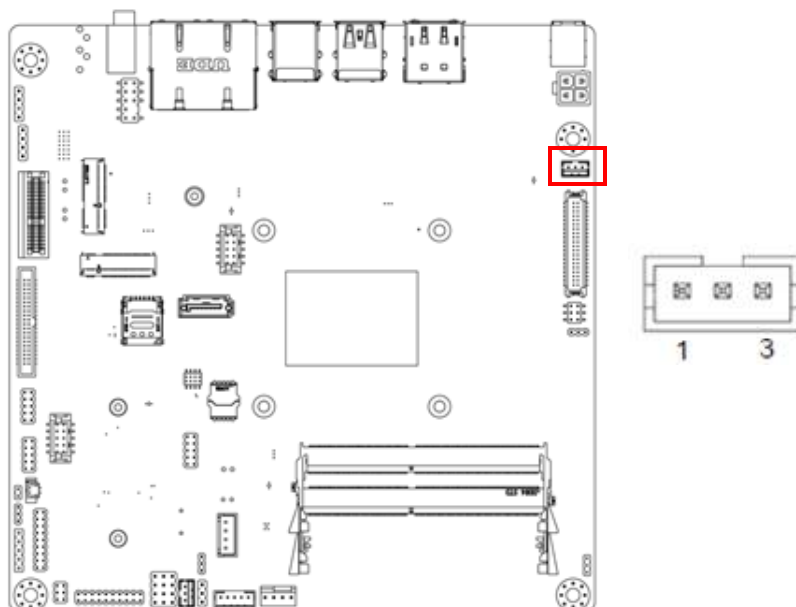

2.25 Front Panel Connectors (JFP1)

Several external switches are provided for monitoring and controlling the AIMB-218.

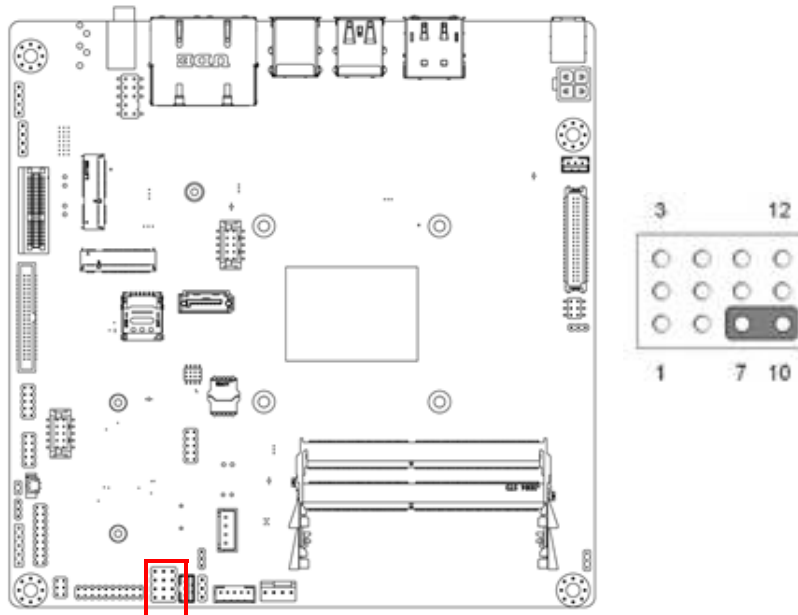

2.25.1 ATX Soft Power Switch (JFP1/PWR_SW)

For computer cases equipped with ATX power supply, users should connect the Power On/Off button on the computer case to (JFP1 + JFP2/PWR_SW) for convenient Power On/Off functionality.

2.25.2 Reset (JFP1/RESET)

Many computer cases offer the convenience of a specific reset button. Connect the wire for the reset button.

2.25.3 HDD LED (JFP1/HDDLED)

An LED can be linked to the connector (JFP2/HDDLED) to indicate when the HDD is active.

2.25.4 External Speaker (JFP1/SPEAKER)

(JFP1/SPEAKER) is a four-pin connector for an external speaker. If no external speaker is available, the AIMB-218 provides an onboard buzzer as an alternative. To enable the buzzer, set Pins 7-10 as closed.

Chapter 3

BIOS Operation

3.1 Introduction

With the AMI BIOS Setup program, you can modify BIOS settings and control the special features of your computer. The Setup program uses a number of menus for making changes and turning special features on or off. This chapter describes the basic navigation of the AIMB-218 setup screens.

3.2 BIOS Setup

The AIMB-218 Series system has AMI BIOS built in, with a CMOS SETUP utility that allows users to configure required settings or to activate certain system features. The CMOS SETUP saves the configuration in the CMOS RAM of the motherboard. When the power is turned off, the battery on the board supplies the necessary power to preserve the CMOS RAM.

When the power is turned on, press the button during the BIOS POST (Power-On Self Test) to access the CMOS SETUP screen.

Control Keys

< ↑ >< ↓ >< ← >< → >	Move to select item
----------------------	---------------------

<Enter>	Select item
---------	-------------

<Esc>	Main Menu - Quit and not save changes into CMOS Sub Menu - Exit current page and return to Main Menu
-------	---

<Page Up/+>	Increase the numeric value or make changes
-------------	--

<Page Down/->	Decrease the numeric value or make changes
---------------	--

<F1>	General help, for Setup Sub Menu
------	----------------------------------

<F2>	Item Help
------	-----------

<F5>	Load Previous Values
------	----------------------

<F7>	Load Setup Defaults
------	---------------------

<F10>	Save all CMOS changes
-------	-----------------------

3.2.1 Main Menu

Press to enter AMI BIOS CMOS Setup Utility, the Main Menu will appear on the screen. Use arrow keys to select among the items and press <Enter> to accept or enter the sub-menu.



The Main BIOS setup screen has two main frames. The left frame displays all the options that can be configured. Grayed-out options cannot be configured; options in blue can. The right frame displays the key legend.

Above the key legend is an area reserved for a text message. When an option is selected in the left frame, it is highlighted in white. Often a text message will accompany it.

■ System time/System date

Use this option to change the system time and date. Highlight System Time or System Date using the <Arrow> keys. Enter new values through the keyboard. Press the <Tab> key or the <Arrow> keys to move between fields. The date must be entered in MM/DD/YY format. The time must be entered in HH:MM:SS format.

3.2.2 Advanced BIOS Features

Select the Advanced tab from the AIMB-218 setup screen to enter the Advanced BIOS Setup screen. You can select any of the items in the left frame of the screen, such as CPU Configuration, to go to the sub menu for that item. You can display an Advanced BIOS Setup option by highlighting it using the <Arrow> keys. All Advanced BIOS Setup options are described in this section. The Advanced BIOS Setup screen is shown below. The sub menus are described on the following pages.

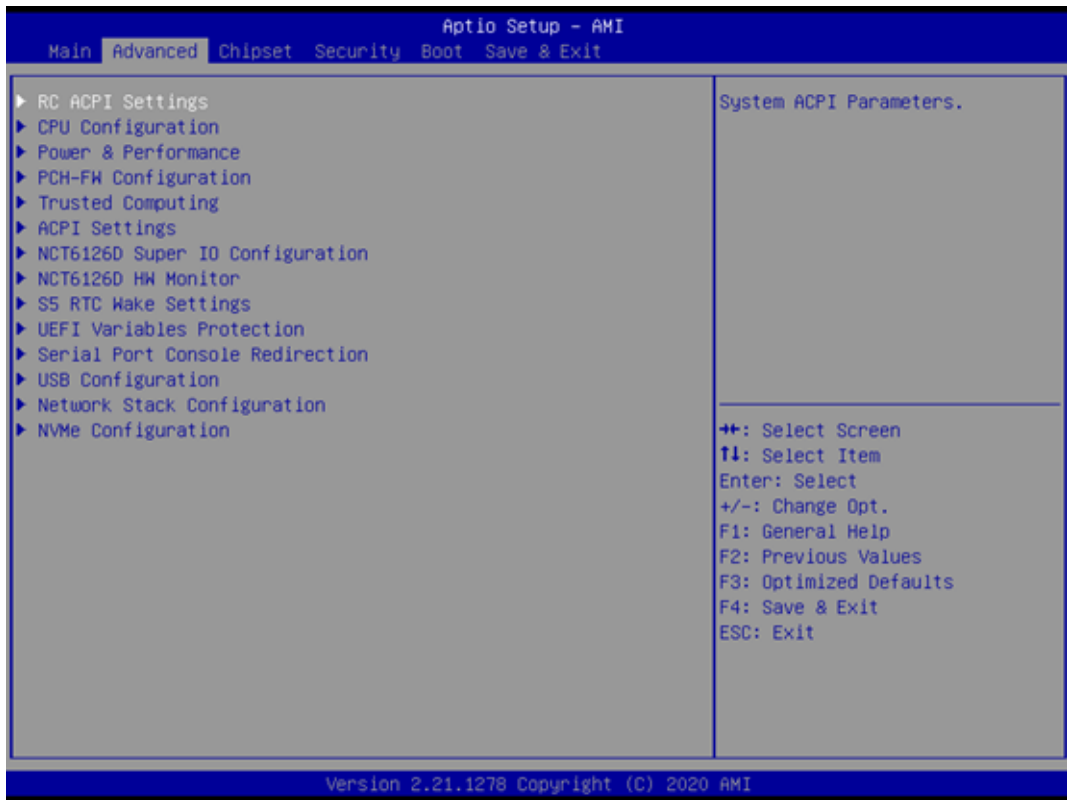

3.2.2.1 Trusted Computing

To enable/disable TPM 2.0 set up in BIOS. TPM (Trusted Platform Module) is a secure key generator and key cache management component, enables protected storage of encryption keys and authentication credentials for enhanced security capabilities.



■ Security Device Support [Disable]

Note! TCG EFI Protocol and INT1A interface won't be available.



3.2.2.2 ACPI Settings

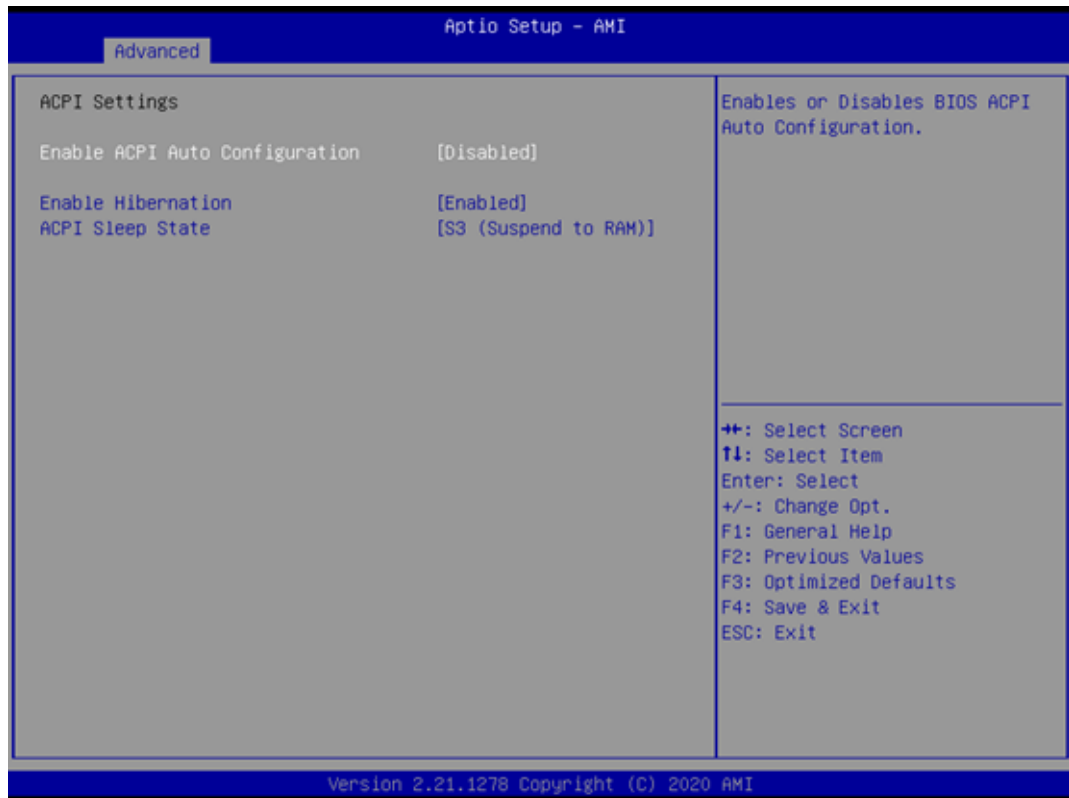

- **Enable ACPI Auto Configuration [Disabled]**
Enable or disable BIOS ACPI auto configuration.
- **Enable Hibernation [Enabled]**
Enables or Disables System ability to Hibernate (OS/S4 Sleep State). This option may be not effective with some OS.
- **ACPI Sleep State [Auto]**
Select ACPI sleep state the system will enter when the SUSPEND button is pressed.

3.2.2.3 PCH Configuration

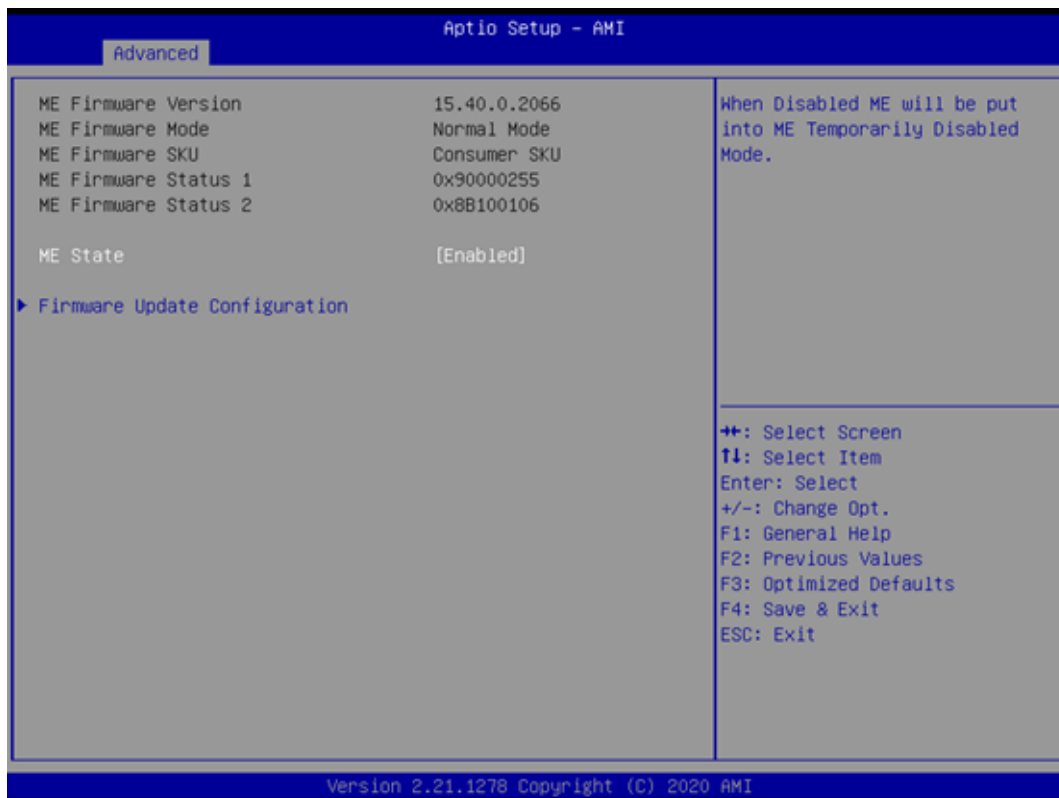

■ Firmware update Configuration



■ ME FW Image Re-Flash [Disabled]

3.2.2.4 NCT6126D Super IO Configuration

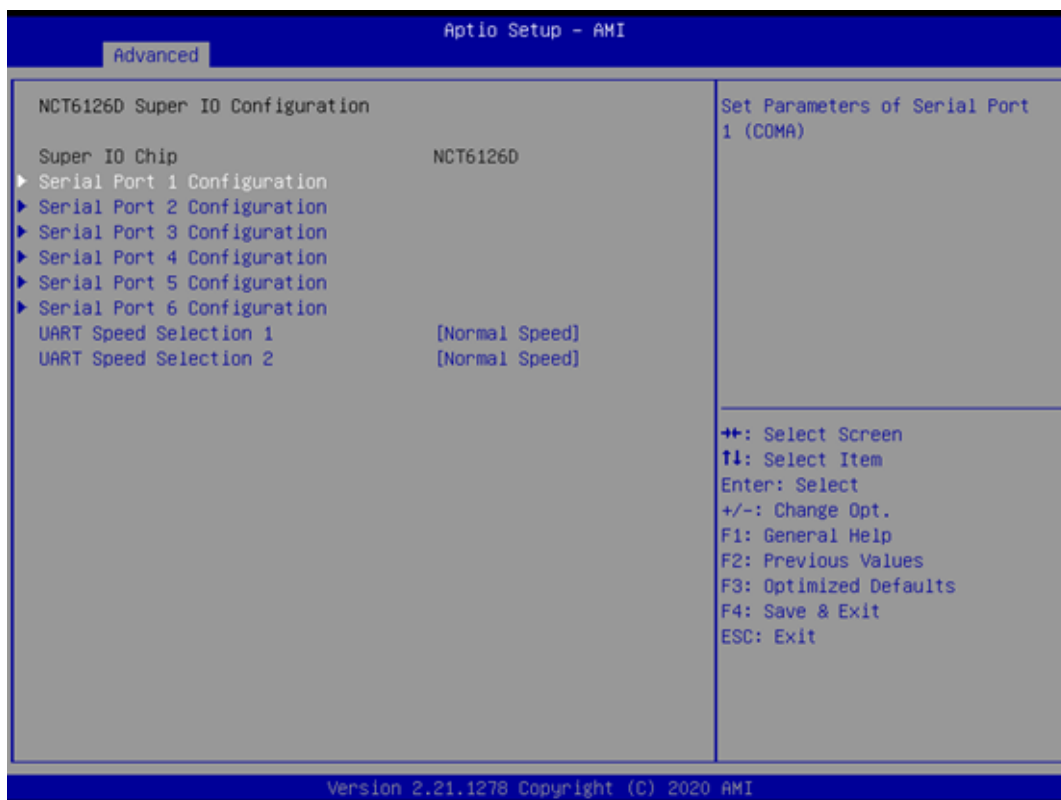

- **Super IO Chip [NCT6126D]**

■ Serial Port 1 Configuration



- **Serial Port [Enabled]**
- **Device Settings: IO=3F8h; IRQ =4**
- **Change Settings [Auto]**
Select an optimal setting for serial port 1.

■ Serial Port 2 Configuration



- **Serial Port [Enabled]**
- **Device Settings: IO=2F8h; IRQ =3**
- **Change Setting [Auto]**
Select an optimal setting for serial port 2.
- **Device Mode [RS232]**

■ Serial Port 3 Configuration

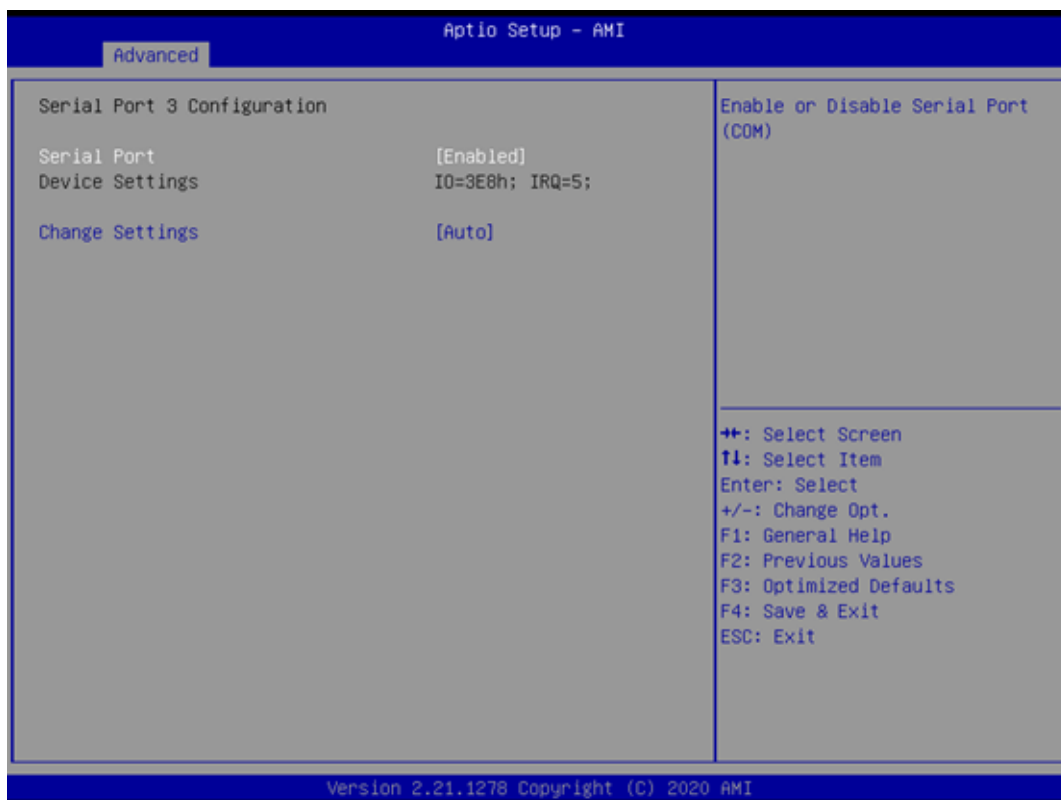

- **Serial Port [Enabled]**
- **Device Settings: IO=3F8h; IRQ =5**
- **Change Setting [Auto]**
Select an optimal setting for serial port 2.

■ Serial Port 4 Configuration



- **Serial Port [Enabled]**
- **Device Settings: IO=2E8h; IRQ =7**
- **Change Setting [Auto]**
Select an optimal setting for serial port 4.

■ Serial Port 5 Configuration



- **Serial Port [Enabled]**
- **Device Settings: IO=220h; IRQ =10**
- **Change Setting [Auto]**
Select an optimal setting for serial port 5.

■ Serial Port 6 Configuration



- **Serial Port [Enabled]**
- **Device Settings: IO=228h; IRQ =11**
- **Change Setting [Auto]**
Select an optimal setting for serial port 6.

■ Digital I/O Configuration

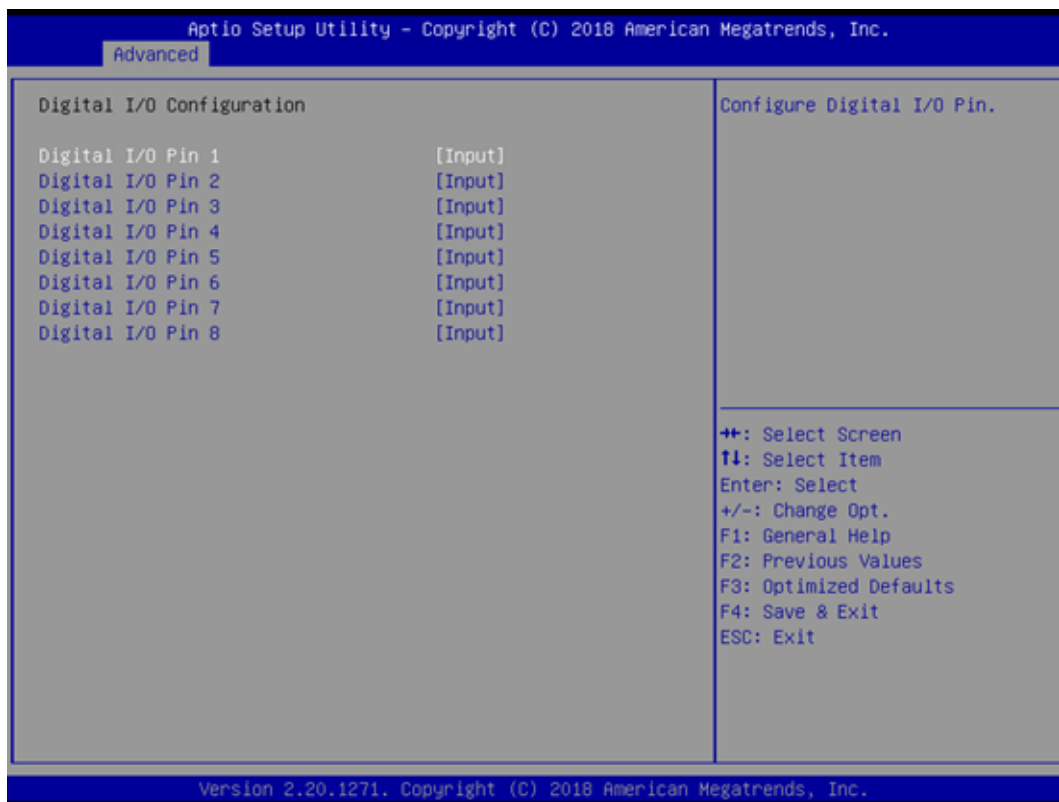

■ Digital I/O Pin 1 - 8 [Input]

3.2.2.5 NCT6126D HW Monitor

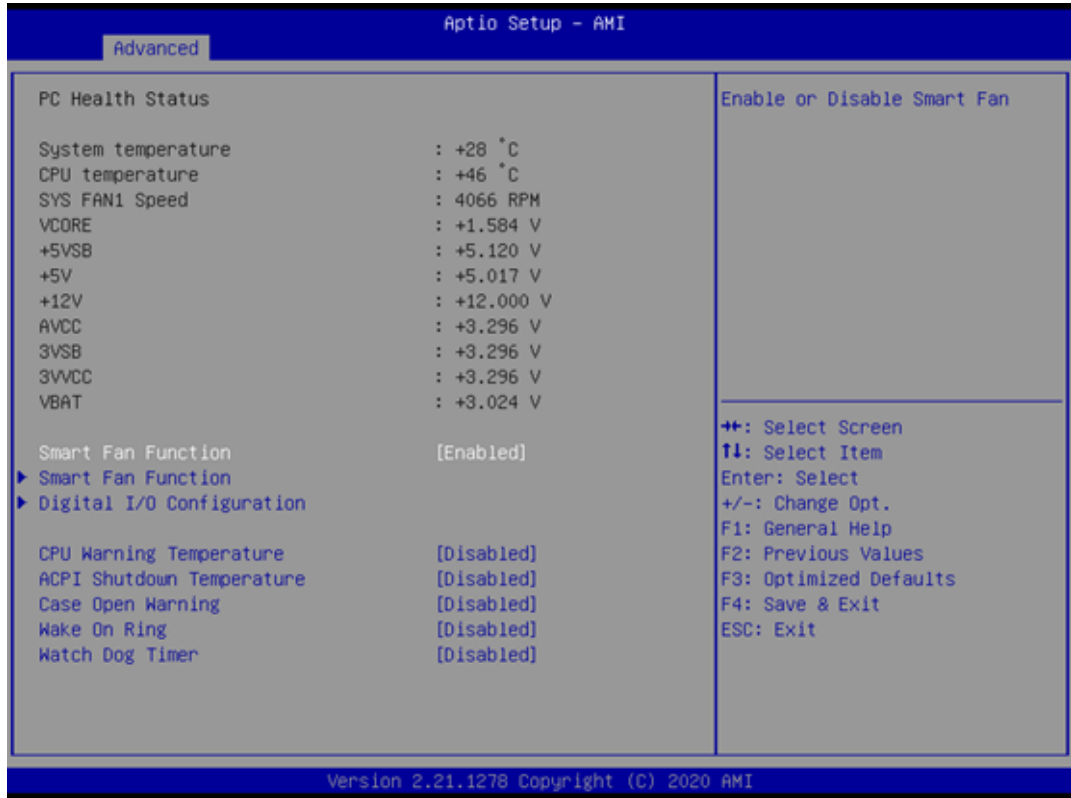

- **CPU Warning Temperature [Disabled]**
Use this to set the CPU warning temperature threshold. When the system reaches the warning temperature, the speaker will beep.
- **ACPI Shutdown Temperature [Disabled]**
Use this to set the ACPI shutdown temperature threshold. When the system reaches the shutdown temperature, it will be automatically shut down by ACPI OS to protect the system from overheating damage.

■ Smart Fan Mode Configuration

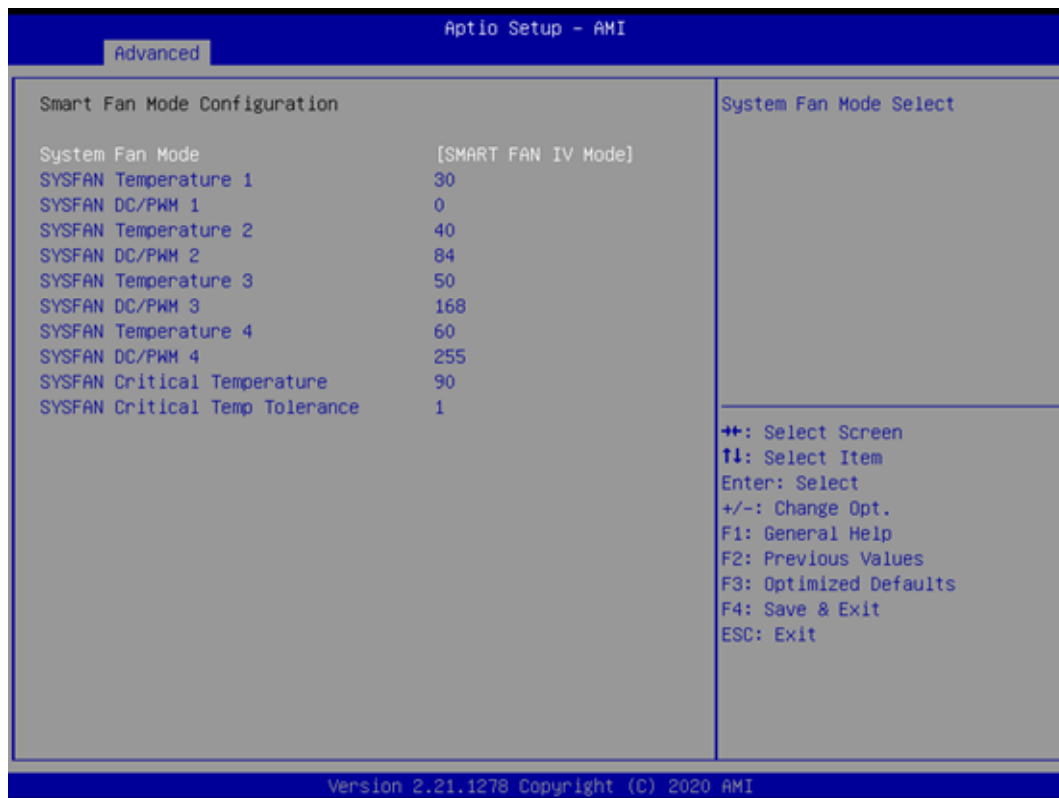

■ SYSFAN Mode [SMART FAN IV Mode]

The item shows you system temperature and fan speed (PWM) information.

3.2.2.6 S5 RTC Wake Settings

The item allows you enable or disable system wake up on alarm event.



■ Wake system with Fixed Time [Disabled]

Note! When enabled, system will wake up on the specified time.



3.2.2.7 Serial Port Console Redirection

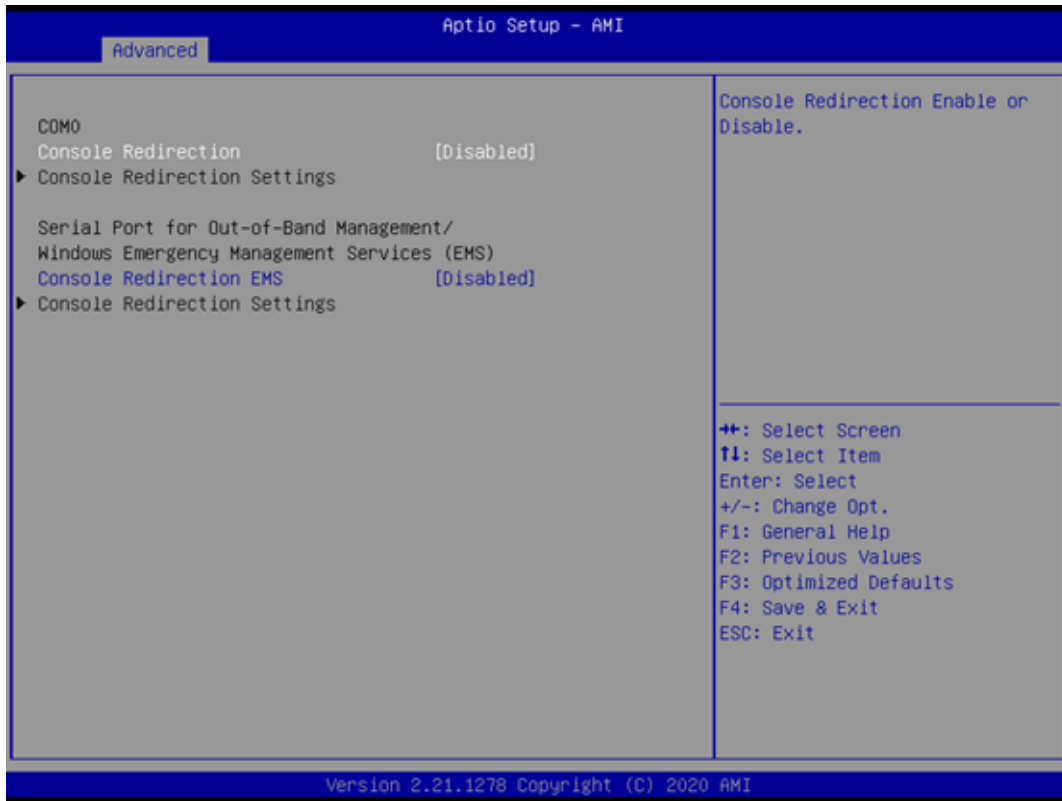

- **Console Redirection [Disabled]**
Enable or disable the console redirection feature.

3.2.2.8 Network Stack Configuration [Disabled]



■ Network Stack [Disabled]

Note! When network stack [enable], item must enable: LANx PXE OpROM [enable].



3.2.2.9 USB Configuration

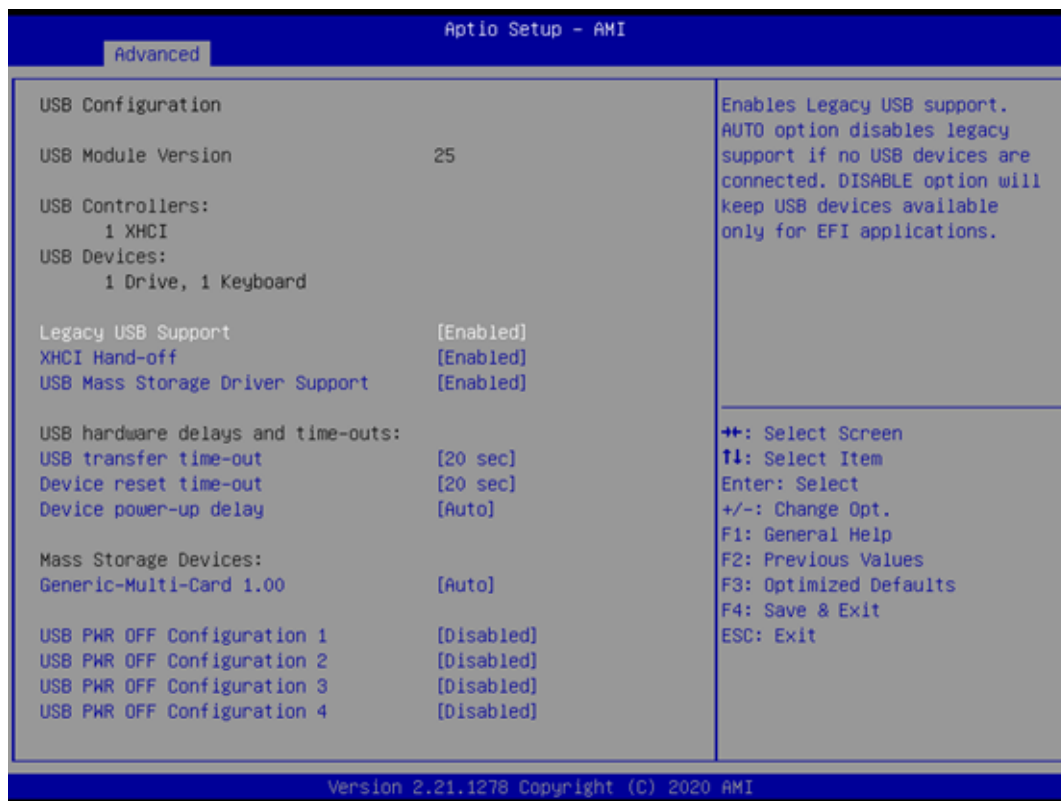

- **Legacy USB Support [Enabled]**
Enables support for legacy USB. Auto option disables legacy support if no USB devices are connected.
- **XHCI Hand-off [Enabled]**
- **USB Mass Storage Driver Support [Enabled]**
- **USB hardware delays and time-outs**
USB Device transfer & reset time-out and delay setting.
- **Mass Storage Devices [Auto]**
Shows USB mass storage device information.
- **USB PWR OFF Configuration [Disabled]**
Enable to stop support for USB power delivery under S5.

Note! USB power current delivery under S5 is 1.8A max.



3.3 Chipset Configuration Setting

Select the chipset tab from the BIOS setup screen to enter the Chipset Setup screen. Users can select any item in the left frame of the screen, such as PCI express Configuration, to go to the sub menu for that item. Users can display a Chipset Setup option by highlighting it using the <Arrow> keys. All Chipset Setup options are described in this section. The Chipset Setup screens are shown below. The sub menus are described on the following pages.



3.3.1 System Agent (SA) Configuration



- **VT-d [Enabled]**
Disable or enable VT-d function on MCH.

3.3.1.1 Memory Configuration

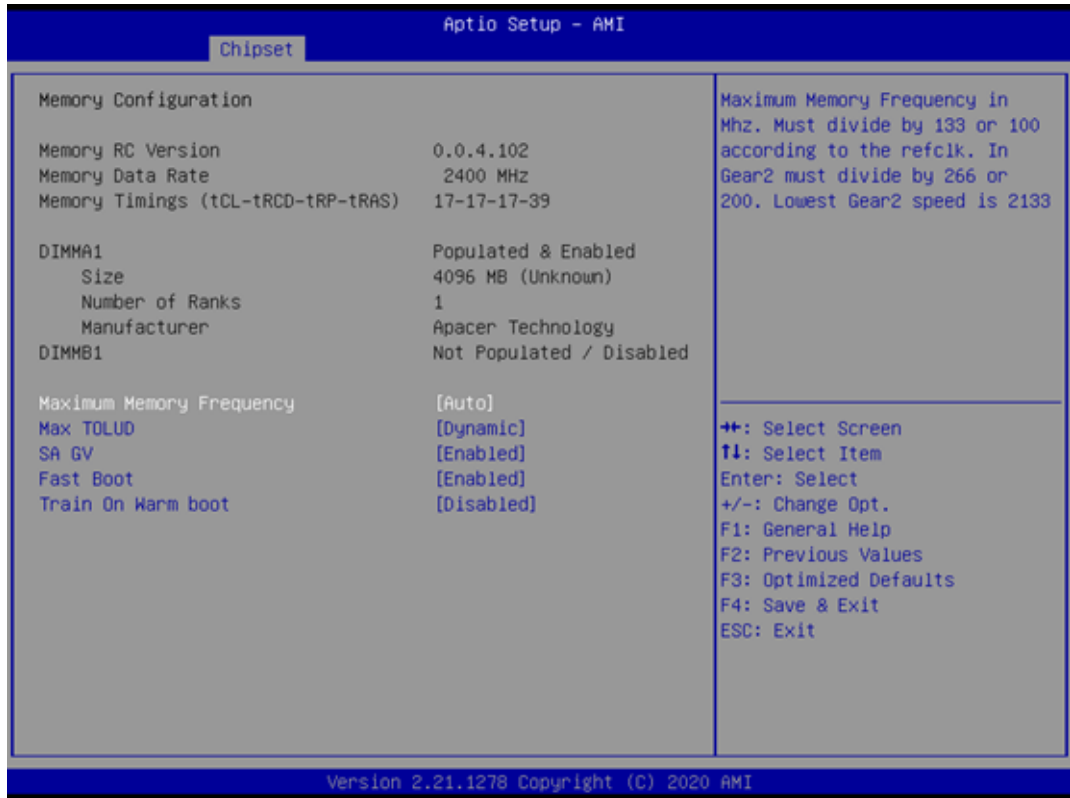

The item shows you memory specification included RC version, Frequency, size and voltage information etc.

- **Max TOLUD [Dynamic]**
Maximum Value of TOLUD. Dynamic assignment would adjust TOLUD automatically based on largest MMIO length of installed graphic controller.
- **Fast Boot [Enabled]**
Enable or disable Fast Boot support.

3.3.1.2 Graphics Configuration

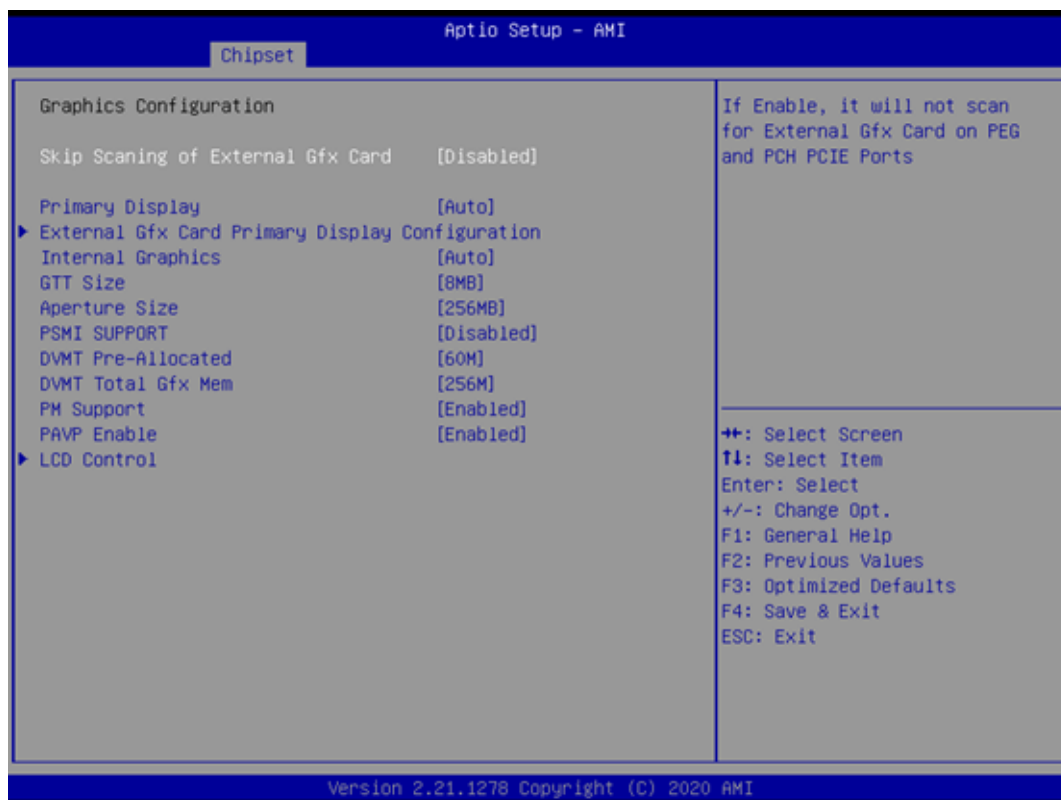

- **Skip Scanning of External Gfx Card [disabled]**
- **Primary Display [Auto]**
Select which of IGFX/PEG/PCI Graphics device should be the Primary Display.
- **Internal Graphics [Auto]**
Keep IGD enabled based on the setup options.
- **GTT size [8MB]**
- **Aperture Size [256MB]**
- **DVMT Pre-Allocated [60M]**
Select DVMT 5.0 pre-allocated (fixed) graphics memory size used by the internal graphics device.
- **DVMT Total Gfx Mem [256M]**
Select DVMT5.0 total graphic memory size used by the internal graphics device.

LCD Control

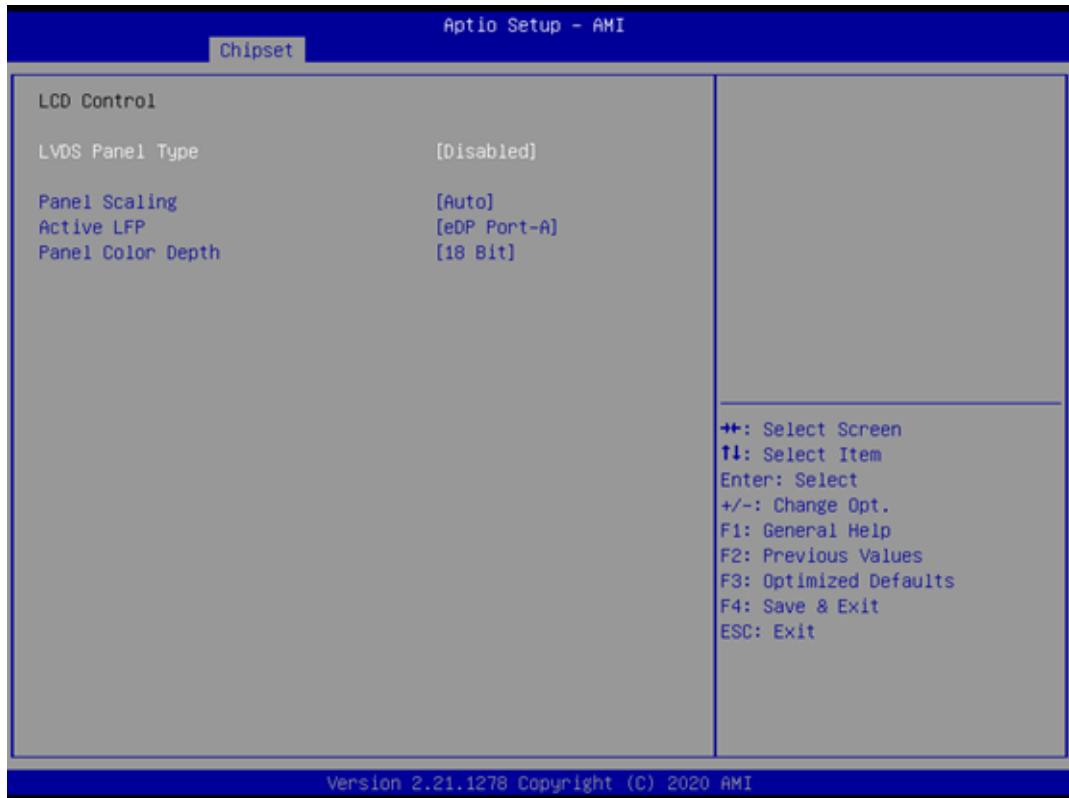

- **LVDS Panel Type [Disabled]**
- **Panel Scaling [Auto]**
- **Panel Color Depth [18 Bit]**

3.3.2 PCH-IO Configuration



- **PCI Express Configuration**
Details of PCI Express items. (See 3.3.2.1.)
- **Security Configuration**
Details of BIOS security items. (See 3.3.2.3.)
- **LAN 1 controller [Enabled]**
Enable or disable the LAN 1 controller.
- **LAN 2 controller [Enabled]**
Enable or disable the LAN 2 controller.
- **PCIE Wake [Disabled]**
Enable or disable PCIE to wake the system from S5.
- **State After G3 [Power Off]**
This item allows users to select off, on and last state.

3.3.2.1 PCI Express Configuration



- **PCH PCI Express Clock Gating [Platform-POR]**
Enable or Disable PCI Express clock gating for each port.

■ LAN1 Controller



- **LAN1 Controller [Enabled]**
Controls the LAN1 controller Root Port.
- **ASPM Support [Auto]**
Sets the ASPM Level: Force L0s - Force all links to L0s State: AUTO - BIOS.
auto configure: DISABLE - Disables ASPM.
- **L1 Substates PCI Express L1 Substates settings [L1.1 & L1.2]**
- **PCIe Speed [Auto]**

■ LAN2 Controller



- **LAN2 Controller [Enabled]**
Controls the LAN2 controller Root Port.
- **ASPM Support [Auto]**
Sets the ASPM Level: Force L0s - Force all links to L0s State: AUTO - BIOS.
auto configure: DISABLE - Disables ASPM.
- **L1 Substates PCI Express L1 Substates settings [L1.1 & L1.2]**
- **PCIe Speed [Auto]**

- **M.2 B-key slot**



- **PCIE x1/M.2 B-Key slot [Enabled]**
Controls the PCIE x1/M.2 B-Key Root Port.
- **ASPM [Auto]**
Sets the ASPM Level: Force L0s - Force all links to L0s State: AUTO - BIOS.
auto configure: DISABLE - Disables ASPM.
- **L1 Substates PCI Express L1 Substates settings [L1.1 & L1.2]**
- **PCIe Speed [Auto]**
Selects M.2 B-Key port speed.

■ M.2 E-key slot



- **M.2 E-Key slot [Enabled]**
Controls the M.2 E-Key Root Port.
- **ASPM [Auto]**
Sets the ASPM Level: Force L0s - Force all links to L0s State: AUTO - BIOS. auto configure: DISABLE - Disables ASPM.
- **L1 Substates PCI Express L1 Substates settings [L1.1 & L1.2]**
- **PCIe Speed [Auto]**
Selects M.2 E-Key port speed.

3.3.2.2 SATA and RST Configuration

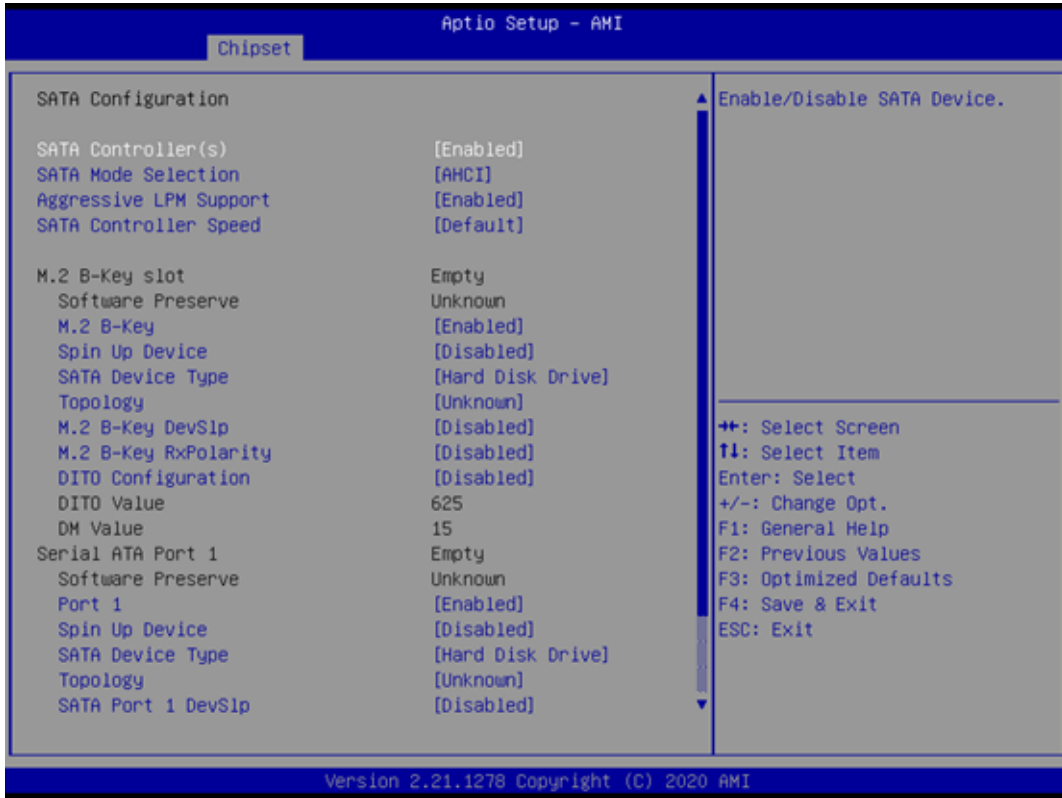

3.4 Security Setting

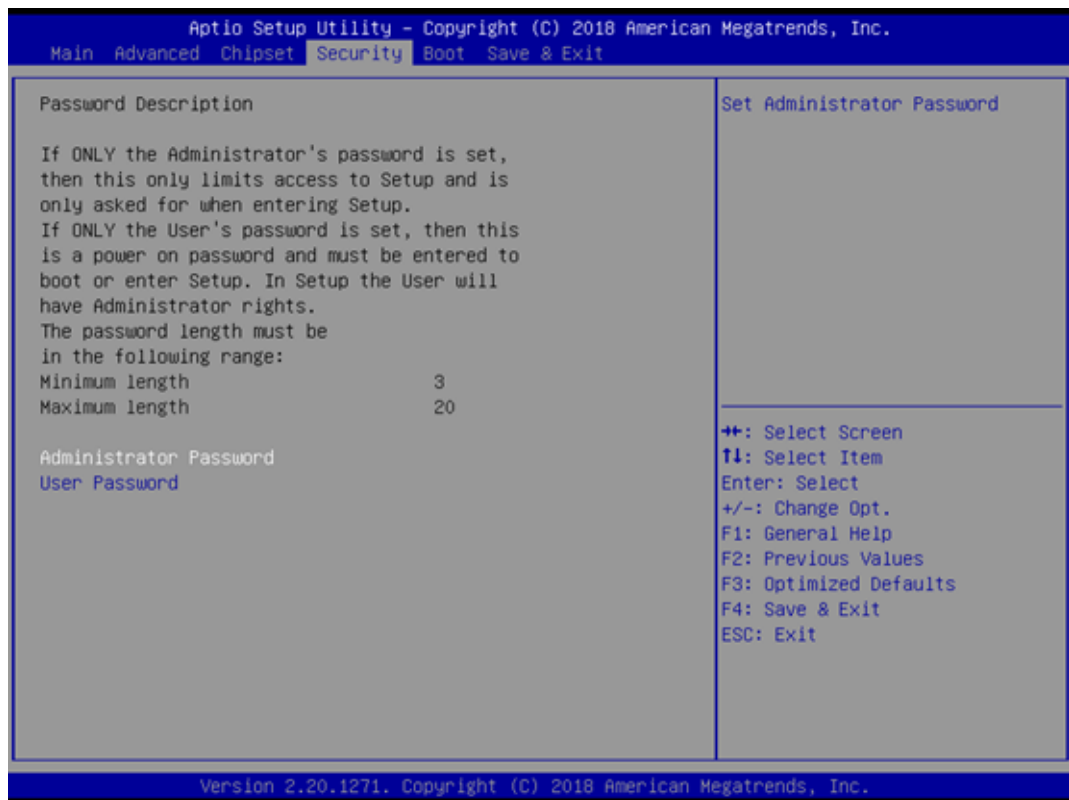

- **Administrator Password**
Select this option and press <ENTER> to access the sub menu, and then type in the password. Set the Administrator password.
- **User Password**
Select this option and press <ENTER> to access the sub menu, and then type in the password. Set the User Password.

3.5 Boot Setting



- **Setup Prompt Timeout**
Use the <+> and <-> keys to adjust the number of seconds to wait for setup activation key.
- **Bootup NumLock State [On]**
On or Off power on state for the NumLock.
- **Quiet Boot [Disabled]**
If this option is set to disabled, the BIOS displays normal POST messages. If enabled, an OEM logo is shown instead of POST messages.
- **Boot Option #1/#2**
Choose boot priority from boot device.

3.6 Save & Exit Configuration

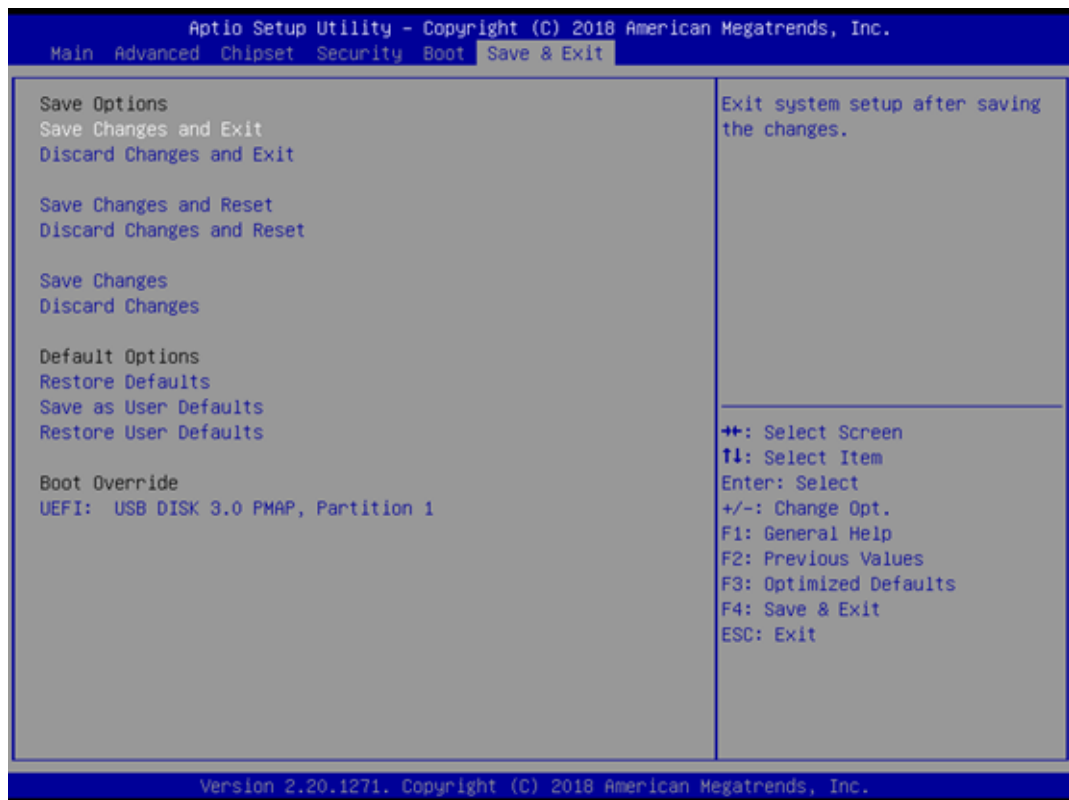

- **Save Changes and Exit**

When users have completed system configuration, select this option to save changes, exit BIOS setup menu and reboot the computer to take effect all system configuration parameters.

 - (1) Select Exit Saving Changes from the Exit menu and press <Enter>. The following message appears: Save Configuration Changes and Exit Now? [Ok] [Cancel]
 - (2) Select Ok or cancel.
- **Discard Changes and Exit**

Select this option to quit Setup without making any permanent changes to the system configuration.

 - (1) Select Exit Discarding Changes from the Exit menu and press <Enter>. The following message appears: Discard Changes and Exit Setup Now? [Ok] [Cancel]
 - (2) Select Ok to discard changes and exit. Discard Changes Select Discard Changes from the Exit menu and press <Enter>.
- **Save Changes and Reset**

When users have completed system configuration, select this option to save changes, exit BIOS setup menu and reboot the computer to take effect all system configuration parameters.

 - (1) Select Exit Saving Changes from the Exit menu and press <Enter>. The following message appears: Save Configuration Changes and Exit Now? [Ok] [Cancel]
 - (2) Select Ok or cancel.
- **Discard Changes and Reset**

Select this option to quit Setup without making any permanent changes to the system configuration.

(1) Select Reset Discarding Changes from the Exit menu and press <Enter>. The following message appears: Discard Changes and Exit Setup Now? [Ok] [Cancel]

(2) Select Ok to discard changes and reset. Discard Changes Select Discard Changes from the Exit menu and press <Enter>.

- **Restore Default**

The BIOS automatically configures all setup items to optimal settings when users select this option. Defaults are designed for maximum system performance, but may not work best for all computer applications. In particular, do not use the Defaults if the user's computer is experiencing system configuration problems. Select Restore Defaults from the Exit menu and press <Enter>.

- **Save as User Default**

Saves the all current settings as a user default.

- **Restore User Default**

Restore all settings to user default values.

Chapter 4

Software and Service
Introduction

4.1 Introduction

The mission of Advantech Embedded Software Services is to “enhance users’ quality of life with Advantech platforms and Microsoft® Windows® embedded technology”. We equip Advantech platforms with Windows® embedded software products to more effectively support the embedded computing community. This eliminates the hassle of dealing with multiple vendors (hardware suppliers, system integrators, and embedded OS distributors) for specific projects. Our aim is to make Windows® embedded software solutions widely available to the embedded computing community.

4.2 Value-Added Software Services

Software API: An interface that defines the ways in which an application program may request services from libraries and/or operating systems. This software provides not only the underlying drivers required, but also a rich set of user-friendly, intelligent, and integrated interfaces that speed development, enhance security, and offer add-on value for Advantech platforms. Furthermore, this software serves as a catalyst between developers and solutions, making Advantech embedded platforms easier and simpler to adopt and operate with customer applications.

4.2.1 Software API

4.2.1.1 Control

GPIO



General purpose input/output is a flexible parallel interface that allows various custom connections. This interface also enables users to monitor the level of signal input or set the output status to switch the device on or off. Our API also provides programmable GPIO, enabling developers to dynamically set the GPIO input or output status.

SMBus



SMBus is a system management bus defined by Intel Corporation in 1995. This interface is used in personal computers and servers for low-speed system management communications. The SMBus API allows developers to interface with an embedded system environment and transfer serial messages using SMBus protocols, facilitating multiple simultaneous device control.

4.2.1.2 Display

Brightness Control



The Brightness Control API allows developers to access embedded devices and easily control brightness.

Backlight



The Backlight API allows developers to control the backlight (screen) in embedded devices.

4.2.1.3 Monitor

Watchdog



A watchdog timer is a device that performs a specific operation after a specified period of time when a malfunction occurs and the system cannot recover on its own. A watchdog timer can be programmed to perform a warm booting (system restart) after a certain number of seconds.

Hardware Monitor



The Hardware Monitor API is a system health supervision API that inspects certain condition indices, such as fan speed, temperature, and voltage.

4.2.1.4 Power Saving

CPU Speed



This feature uses Intel SpeedStep® Technology to reduce the system power consumption. The system automatically adjusts the CPU speed according to the system load.

System Throttling

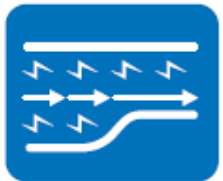

This refers to a series of methods for reducing system power consumption by lowering the clock frequency. This API allows users to adjust the clock frequency from 87.5% to 12.5%.

4.2.2 Software Utility

BIOS Flash

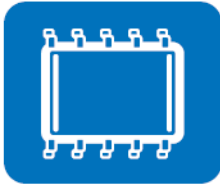

The BIOS Flash utility allows customers to update the flash ROM BIOS version, or backup the current BIOS by copying the configuration from the flash chip to a file on the users' disk. The BIOS Flash utility also features a command line version and API for rapid implementation in customized applications.

Embedded Security ID



Embedded applications are the most important responsibilities for system integrators because they contain valuable intellectual property, design knowledge, and innovations, and are easily copied. This Embedded Security ID utility offers reliable security functions that allow users to secure application data within embedded BIOS.

Monitoring



The Monitoring API is a utility that allows users to monitor the system health indicators, such as voltage, CPU and system temperature, and fan speed. These system values are crucial. If critical errors occur and are not solved immediately, permanent damage to the device may result.

Chapter 5

Chipset Software
Install Utility

5.1 Before Installation

Before installing the enhanced display drivers and utility software, please read the instructions provided in this chapter carefully. The drivers for AIMB-218 are provided on Advantech support website: <http://support.advantech.com/Support/>. This driver will guide and link users to the utilities and drivers required for Microsoft Windows-based systems. Software updates can be accessed from Microsoft* software service packs.

Note! *The files on the website are compressed. Do not attempt to install the drivers by copying the files manually. The Setup program provided must be used to install the drivers.*



Please note, for most display drivers, the relevant software application must be installed on the system before enhanced display drivers can be installed. In addition, for many of the installation procedures, user familiarity with both the relevant software applications and operating system commands is assumed. Thus, users are advised to review relevant operating system commands and pertinent sections of the application software user manual before attempting installation.

5.2 Introduction

The Intel® Chipset Software Installation (CSI) utility installs the Microsoft Windows INF files that specify the chipset component configuration on the OS. This is essential to enable the following features and functionality:

- Core PCI PnP services
- Serial ATA interface support
- USB support
- Identification of Intel® chipset components in the device manager

Note! *This utility is used for the following versions of Windows, and it has to be installed before installing all the other drivers:*



- Windows 10 (64 bit)

Chapter 6

Graphics Setup

6.1 Introduction

To benefit from the Intel® Pentium J6425, Celeron J6413, Celeron N6211, Atom x6413E integrated graphics controller, users must install the graphics driver.

6.2 Windows 10

Note! Before installing this driver, ensure the CSI utility is installed on the system. See Chapter 5 for information regarding installing the CSI utility.



Download the driver from website on your computer. Navigate to the “Graphics” folder and click “setup.exe” to complete the installation of the drivers for Windows 10.

Chapter 7

LAN Configuration

7.1 Introduction

The AIMB-218 system features dual Gigabit Ethernet LANs via dedicated PCI Express x1 lanes (Realtek RTL8111H (LAN1) and Realtek RTL8111H (LAN2)) that offer a bandwidth of up to 500 MB/sec, eliminating bottlenecks in the flow of network data by incorporating Gigabit Ethernet at 1000 Mbps.

7.2 Features

- Integrated 10/100/1000 Mbps transceiver
- 10/100/1000 Mbps triple-speed MAC
- High-speed RISC core with 24-KB cache
- On-chip voltage regulation
- Wake-on-LAN (WOL) support
- PCI Express X1 host interface

7.3 Installation

Note! Before installing LAN drivers, ensure the CSI utility is installed on the system. See Chapter 5 for information regarding installing the CSI utility.



The Realtek 8111H (LAN1) and Realtek 8111H (LAN2) Gigabit integrated controllers support all major network operating systems. However, the installation procedure varies between systems. Please follow the driver setup procedure instructions specific to the operating system installed.

7.4 Windows 10 Driver Setup (Realtek 8111G)

Download the driver from website on your computer. Navigate to the "AIMB-218 Realtek LAN" folder and click "setup.exe" to complete the installation of the drivers.

Appendix **A**

Pin Assignments

A.1 DC Input Phoenix Connector (DCIN1)

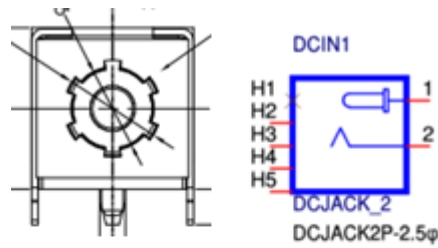

Pin	Signal Pin Definition
1	Power input (Only +12V)
2	GND

A.2 Definition Multimedia Interface (DP1+HDMI1)

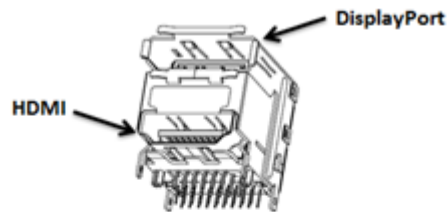

Pin	Signal Pin Definition	Pin	Signal Pin Definition
1	HDMI1_Z_D2+	A1	DP1_0+
2	GND	A2	GND
3	HDMI1_Z_D2-	A3	DP1_0-
4	HDMI1_Z_D1+	A4	DP1_1+
5	GND	A5	GND
6	HDMI1_Z_D1-	A6	DP1_1-
7	HDMI1_Z_D0+	A7	DP1_2+
8	GND	A8	GND
9	HDMI1_Z_D0-	A9	DP1_2-
10	HDMI1_Z_CLK+	A10	DP1_3+
11	GND	A11	GND
12	HDMI1_Z_CLK-	A12	DP1_3-
13	x	A13	DP1_AUX_EN#
14	x	A14	GND
15	HDMI1_SCL	A15	DP1_AUX+
16	HDMI1_SDA	A16	GND
17	GND	A17	DP1_AUX-
18	+V5_HDMI	A18	DP1_HPD
19	HDMI1_HPD	A19	GND
		A20	+V3.3_DP1

A.3 USB 3.0+2.0 Stack Connector (USB34)



Pin	Signal Pin Definition	Pin	Signal Pin Definition
1	+5V	10	+5V
2	USB2_D3-	11	USB2_D2-
3	USB2_D3+	12	USB2_D2+
4	GND	13	GND
5	USB31_P3_z_RX-		
6	USB31_P3_z_RX+		
7	GND		
8	USB31_P3_z_TX-		
9	USB31_P3_z_TX+		

A.4 USB 3.0 Stack Connector (USB34)



Pin	Signal Pin Definition	Pin	Signal Pin Definition
1	+5V	10	+5V
2	USB2_D0-	11	USB2_D1-
3	USB2_D0+	12	USB2_D1+
4	GND	13	GND
5	USB31_P0_z_RX-	14	USB31_P1_z_RX-
6	USB31_P0_z_RX+	15	USB31_P1_z_RX+
7	GND	16	GND
8	USB31_P0_z_TX-	17	USB31_P1_z_TX-
9	USB31_P0_z_TX+	18	USB31_P1_z_TX+

A.5 RJ45 1 Port (LAN1)

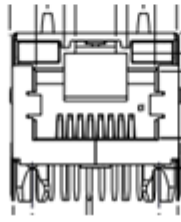

Pin	Signal Pin Definition
R1	LAN1_MDI0+
R2	LAN1_MDI0-
R3	LAN1_MDI1+
R4	LAN1_MDI1-
R5	LAN1_CONN
R6	LAN1_CT
R7	LAN1_MDI2+
R8	LAN1_MDI2-
R9	LAN1_MDI3+
R10	LAN1_MDI3-
L1	LAN1_LED1_ACT#_R
L2	+V3.3_DUAL
L3	LAN1_LED2_1G#_R
L4	LAN1_LED0_100M#_R

A.6 RJ45 2 Port (LAN12)

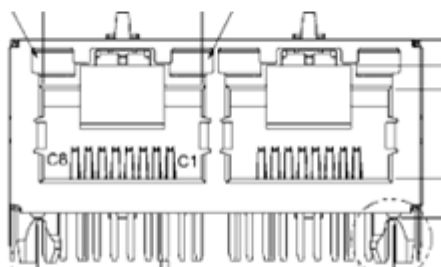

Pin	Signal Pin Definition	Pin	Signal Pin Definition
AR1	LAN1_MDI0+	BR1	LAN2_MDI0+
AR2	LAN1_MDI0-	BR2	LAN2_MDI0-
AR3	LAN1_MDI1+	BR3	LAN2_MDI1+
AR4	LAN1_MDI1-	BR4	LAN2_MDI1-
AR5	LAN1_CONN	BR5	LAN2_CONN
AR6	LAN1_CT	BR6	LAN2_CT
AR7	LAN1_MDI2+	BR7	LAN2_MDI2+
AR8	LAN1_MDI2-	BR8	LAN2_MDI2-
AR9	LAN1_MDI3+	BR9	LAN2_MDI3+
AR10	LAN1_MDI3-	BR10	LAN2_MDI3-
AL1	LAN1_LED1_ACT#_R	BL1	LAN2_LED0_ACT#_R
AL2	+V3.3_DUAL	BL2	+V3.3_DUAL
AL3	LAN1_LED2_1G#_R	BL3	LAN2_LED2_1G#_R
AL4	LAN1_LED0_100M#_R	AL4	LAN2_LED0_100M#_R

A.7 Front HD Analog Audio Interface (FPAUD1)

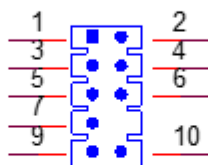

Pin	Signal Pin Definition	Pin	Signal Pin Definition
1	MIC IN L	2	GND
3	MIC IN R	4	FPAUD_DETECT#
5	LINE OUT R	6	SENSE R1
7	SENSE	8	KEY
9	LINE OUT L	10	SENSE R2

A.8 HD Analog Audio Interface Line-Out (AUDIO1)

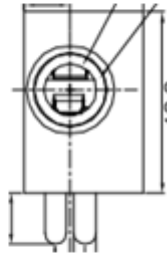

Pin	Signal Pin Definition
1	LINE-Out

A.9 HD Digital Audio Interface (SPDIF1)

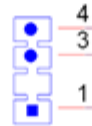

Pin	Signal Pin Definition
1	+5V
3	SPDIF OUT
4	GND

A.10 Audio Amplifier Output Connector (AMP1)

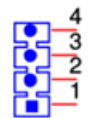

Pin	Signal Pin Definition
1	SPK_R+
2	SPK_R-
3	SPK_L-
4	SPK_L+

A.11 PCI Express X1 Slot (PCIEX1_1)

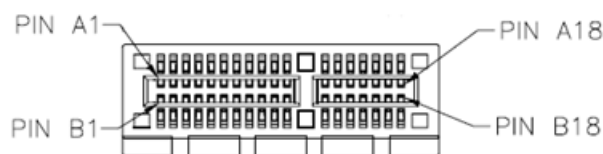

Pin	Signal Pin Definition	Pin	Signal Pin Definition
B1	+12V	A1	PRSNT1#
B2	+12V	A2	+12V
B3	+12V	A3	+12V
B4	GND	A4	GND
B5	SMB_CLK	A5	Reserved
B6	SMB_DATA	A6	Reserved
B7	GND	A7	Reserved
B8	+3.3V	A8	Reserved
B9	Reserved	A9	+3.3V
B10	+3.3VAUX	A10	+3.3V
B11	WAKE#	A11	PWRGD
B12	Reserved	A12	GND
B13	GND	A13	REFCLK+
B14	TX0+	A14	REFCLK-
B15	TX0-	A15	GND
B16	GND	A16	RX0+
B17	Reserved	A17	RX0-
B18	DETECT#	A18	GND
B19	TX1+	A19	CONFIG1
B20	TX1-	A20	GND
B21	GND	A21	RX1+
B22	GND	A22	RX1-
B23	TX2+	A23	GND
B24	TX2-	A24	GND
B25	GND	A25	RX2+
B26	GND	A26	RX2-
B27	TX3+	A27	GND
B28	TX3-	A28	GND
B29	GND	A29	RX3+
B30	Reserved	A30	RX3-
B31	Reserved	A31	GND
B32	GND	A32	CONFIG2

A.12 NGFF M.2 E-Key Connector for 2230 Module (M2E1)

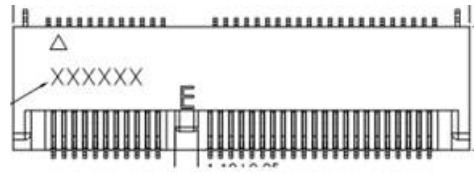

Pin	Signal Pin Definition ⁶	Pin	Signal Pin Definition
1	GND	2	+3.3V
3	USB_D+	4	+3.3V
5	USB_D-	6	WiFi_LED# (I)(OD)
7	GND	8	I2S SCK (O/I)(0/1.8V)
9	NC	10	I2S WS (I/O)(0/1.8V)
11	NC	12	I2S SD_IN (I)(0/1.8V)
13	NC	14	I2S SD_OUT (O)(0/1.8V)
15	NC	16	BT_LED# (I)(OD)
17	NC	18	GND
19	NC	20	UART WAKE# (I)(0/3.3V)
21	NC	22	UART RXD (I)(0/1.8V)
23	NC	24	Connector KEY
25	Connector KEY	26	Connector KEY
27	Connector KEY	28	Connector KEY
29	Connector KEY	30	Connector KEY
31	Connector KEY	32	UART TXD
33	GND	34	UART CTS
35	PETp0	36	UART RTS
37	PETn0	38	NC
39	GND	40	NC
41	PERp0	42	NC
43	PERn0	44	COEX3
45	GND	46	COEX2
47	REFCLKp0	48	COEX1
49	REFCLKn0	50	SUSCLK(32kHz) (O)(0/3.3V)
51	GND	52	PERST0# (O)(0/3.3V)
53	CLKREQ0#	54	W_DISABLE2# (O)(0/3.3V)
55	PEWAKE0#	56	W_DISABLE1# (O)(0/3.3V)
57	GND	58	NC
59	NC	60	NC
61	NC	62	NC
63	GND	64	RESERVED
65	NC	66	RESERVED
67	NC	68	NC
69	GND	70	PCIE_WAKE#
71	NC	72	+3.3V
73	NC	74	+3.3V
75	GND		

A.13 SATA Signal Connector (SATA1)

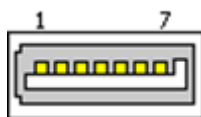

Pin	Signal Pin Definition
1	GND
2	TX+
3	TX-
4	GND
5	RX-
6	RX+
7	GND

A.14 NGFF M.2 B-Key Connector for 2242/2280/3042 Module (M2B1)

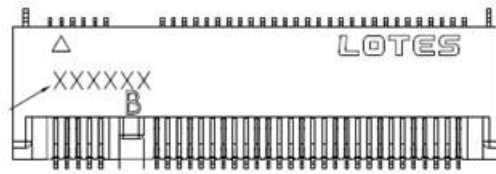

Pin	Signal Pin Definition ⁶	Pin	Signal Pin Definition
1	CONFIG_3	2	+3.3V
3	GND	4	+3.3V
5	GND	6	FULL_CARD_POWER_OFF#
7	USB_D+	8	W_DISABLE1#
9	USB_D-	10	LED
11	GND	12	Connector KEY
13	Connector KEY	14	Connector KEY
15	Connector KEY	16	Connector KEY
17	Connector KEY	18	Connector KEY
19	Connector KEY	20	NC
21	CONFIG_0	22	NC
23	PCIE_WAKE#	24	NC
25	DPR	26	M.2_GNSS_DISABLE#
27	GND	28	NC
29	PERn1/USB3.0-Rx-	30	UIM-RESET (I)
31	PERp1/USB3.0-Rx+	32	UIM-CLK (I)
33	GND	34	UIM-DATA (I/O)
35	PETn1/USB3.0-Tx-	36	UIM-PWR (I)
37	PETp1/USB3.0-Tx+	38	SATA_DEVSLP (O)
39	GND	40	M.2_ISH_SCL
41	PERn0/SATA-B+	42	M.2_ISH_SDA
43	PERp0/SATA-B-	44	NC
45	GND	46	NC
47	PETn0/SATA-A-	48	NC
49	PETp0/SATA-A+	50	PERST#
51	GND	52	CLKREQ#
53	REFCLKn	54	PEWAKE#
55	REFCLKp	56	NC
57	GND	58	NC
59	NC	60	NC
61	NC	62	NC
63	NC	64	NC
65	NC	66	NC
67	RESET#	68	SUSCLK(32kHz)
69	CONFIG_1	70	+3.3V
71	GND	72	+3.3V
73	GND	74	+3.3V
75	CONFIG_2		

A.15 USB 2.0 Pin Header (USB56)

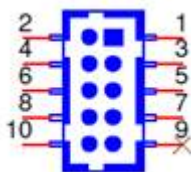

Pin	Signal Pin Definition	Pin	Signal Pin Definition
1	+5V	2	+5V
3	USB2_D5-	4	USB2_D6-
5	USB2_D5+	6	USB2_D6+
7	GND	8	GND
9	NC	10	RESERVED

A.16 COM Port (COM3456)

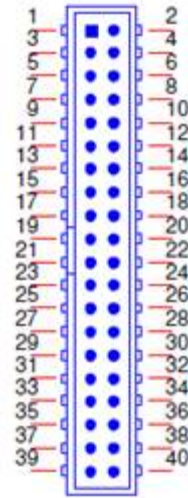

Pin	Signal Pin Definition	Pin	Signal Pin Definition
1	DCD# [3]	2	DSR# [3]
3	RXD [3]	4	RST# [3]
5	TXD [3]	6	CTS# [3]
7	DTR# [3]	8	RI# [3]
9	GND	10	GND
11	DCD# [4]	12	DSR# [4]
13	RXD [4]	14	RST# [4]
15	TXD [4]	16	CTS# [4]
17	DTR# [4]	18	RI# [4]
19	GND	20	GND
21	DCD# [5]	22	DSR# [5]
23	RXD [5]	24	RST# [5]
25	TXD [5]	26	CTS# [5]
27	DTR# [5]	28	RI# [5]
29	GND	30	GND
31	DCD# [6]	32	DSR# [6]
33	RXD [6]	34	RST# [6]
35	TXD [6]	36	CTS# [6]
37	DTR# [6]	38	RI# [6]
39	GND	40	GND

A.17 SIM Card Connector (SIM1)



Pin	Signal Pin Definition
C1	UIM_PWR
C2	UIM_RESET
C3	UIM_CLK
C5	GND
C6	UIM_VPP
C7	UIM_DATA

A.18 SPI Programming Pin Header (SPI_CN1)

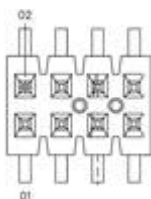

Pin	Signal Pin Definition	Pin	Signal Pin Definition
1	CS#	2	+3.3V
3	MISO	4	NC
5	NC	6	SCK
7	GND	8	MOSI

A.19 SPI BIOS Flash Socket (SPI1)

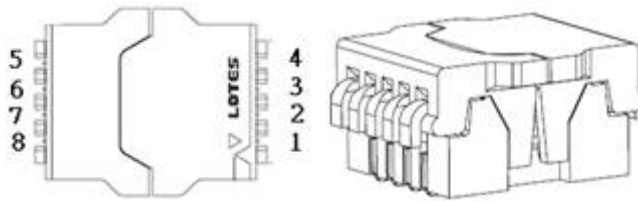

Pin	Signal Pin Definition	Pin	Signal Pin Definition
1	CS#	5	MOSI
2	MISO	6	SCK
3	WP# / IO2	7	HOLD# / IO3
4	GND	8	+3.3V

A.20 USB 2.0 Pin Header (USB78)

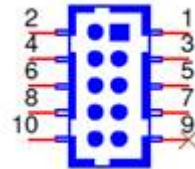

Pin	Signal Pin Definition	Pin	Signal Pin Definition
1	+5V	2	+5V
3	USB2_D7-	4	USB2_D8-
5	USB2_D7+	6	USB2_D8+
7	GND	8	GND
9	NC	10	RESERVED

A.21 ESPI Pin Header (ESPI1)

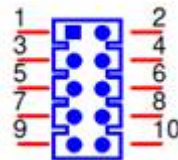

Pin	Signal Pin Definition	Pin	Signal Pin Definition
1	ESPI1_CLK	2	ESPI1_IO1
3	ESPI1_RST#	4	ESPI1_IO0
5	ESPI1_CS#	6	+V3.3
7	ESPI1_IO3	8	GND
9	ESPI1_IO2	10	+V3.3_DUAL

A.22 8-bit General Purpose I/O Pin Header (GPIO1)

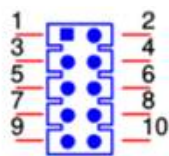

Pin	Signal Pin Definition	Pin	Signal Pin Definition
1	GPIO0	2	GPIO4
3	GPIO1	4	GPIO5
5	GPIO2	6	GPIO6
7	GPIO3	8	GPIO7
9	+V5_DUAL	10	GND

A.23 Case-Open Detect Connector (JCASE1)



Pin	Signal Pin Definition
1	Case Open
2	GND

A.24 COM Port (COM12)

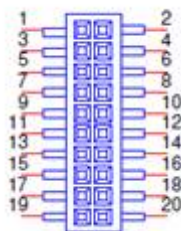

Pin	Signal Pin Definition	Pin	Signal Pin Definition
1	DCD# [1]	2	DSR# [1]
3	RXD [1]	4	RST# [1]
5	TXD [1]	6	CTS# [1]
7	DTR# [1]	8	RI# [1]
9	GND	10	GND
11	DCD# [2]	12	DSR# [2]
13	RXD [2]	14	RST# [2]
15	TXD [2]	16	CTS# [2]
17	DTR# [2]	18	RI# [2]
19	GND	20	GND

A.25 Power LED Pin Header (JFP2)



Pin	Signal Pin Definition
1	SIO_SUSLED_R
2	NC
3	SIO_SUSLED

A.26 LVDS Backlight Inverter Power Connector (INV1)



Pin	Signal Pin Definition
1	+12V
2	GND
3	BKL_EN
4	BKL_CTRL
5	+5V

A.27 SATA Power Connector (SATA_PWR1)

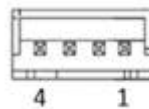

Pin	Signal Pin Definition
1	+V5
2	GND
3	GND
4	+V12

A.28 SYSTEM FAN Power Connector (SYSFAN1)



Pin	Signal Pin Definition
1	GND
2	SYSTEM FAN VCC
3	SYSTEM FAN SPEED
4	SYSTEM FAN PWM

A.29 MPS's I2C/SMBUS Programming for +VCCIN Controller (JSMB1)

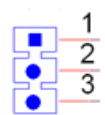

Pin	Signal Pin Definition
1	TPS53655_SMB_CLK
2	TPS53655_SMB_DIO
4	GND

A.30 Low-Voltage Differential Signaling Interface (LVDS_EDP1)

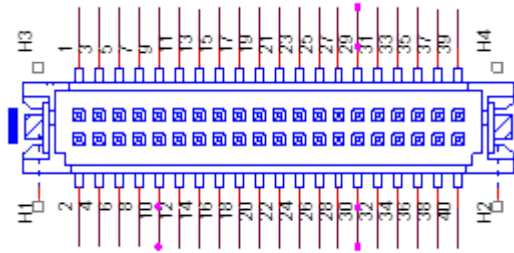

Pin	Signal Pin Definition	Pin	Signal Pin Definition
1	VDD	2	VDD
3	LVDS_DET#	4	GND
5	VDD	6	VDD
7	A0N	8	A4N
9	A0P	10	A4P
11	GND	12	GND
13	A1N	14	A5N
15	A1P	16	A5P
17	GND	18	GND
19	A2N	20	A6N
21	A2P	22	A6P
23	GND	24	GND
25	CLK1N	26	CLK2N
27	CLK1P	28	CLK2P
29	GND	30	GND
31	SCD	32	SDD
33	GND	34	GND
35	A3N	36	A7N
37	A3P	38	A7P
39	ENBKL	40	VCON

A.31 Embedded Displayport (LVDS_EDP1)

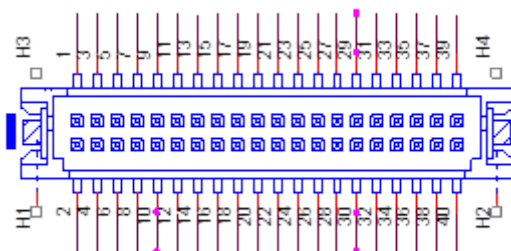

Pin	Signal Pin Definition	Pin	Signal Pin Definition
1	VDD	2	VDD
3	NC	4	GND
5	VDD	6	VDD
7	EDP_TXN2	8	NC
9	EDP_TXP2	10	NC
11	GND	12	GND
13	EDP_TXN1	14	NC
15	EDP_TXP1	16	NC
17	GND	18	GND
19	A2N	20	NC
21	A2P	22	NC
23	GND	24	GND
25	EDP_TXN3	26	NC
27	EDP_TXP3	28	NC
29	GND	30	GND
31	EDP_AUX+	32	EDP_AUX-
33	GND	34	EDP_HPD
35	NC	36	NC
37	NC	38	NC
39	NC	40	NC

A.32 ATX Power Supply (5VSB) Connector (ATX_5VSB1)

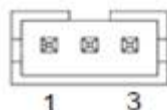

Pin	Signal Pin Definition
1	+V5SB
2	GND
3	PS_ON#

A.33 ATX 12V Power Supply Connector (ATX12V1)

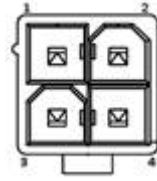

Pin	Signal Pin Definition
1	GND
2	GND
3	+12V
4	+12V

ADVANTECH

Enabling an Intelligent Planet

www.advantech.com

Please verify all specifications before quoting. This guide is intended for reference purpOS only.

All product specifications are subject to change without notice.

No part of this publication may be reproduced in any form or by any means, electronic, photocopying, recording or otherwise, without prior written permission from the publisher.

All brand and product names are trademarks or registered trademarks of their respective companies.

© Advantech Co., Ltd. 2021

Our company network supports you worldwide with offices in Germany, Austria, Switzerland, the UK and the USA. For more information please contact:

Headquarters

Germany



FORTEC Elektronik AG

Augsburger Str. 2b
82110 Germering

Phone: +49 89 894450-0
E-Mail: info@fortecaq.de
Internet: www.fortecaq.de

Fortec Group Members

Austria



Distec GmbH Office Vienna

Nuschinggasse 12
1230 Wien

Phone: +43 1 8673492-0
E-Mail: info@distec.de
Internet: www.distec.de

Germany



Distec GmbH

Augsburger Str. 2b
82110 Germering

Phone: +49 89 894363-0
E-Mail: info@distec.de
Internet: www.distec.de

Switzerland



ALTRAC AG

Bahnhofstraße 3
5436 Würenlos

Phone: +41 44 7446111
E-Mail: info@altrac.ch
Internet: www.altrac.ch

United Kingdom



Display Technology Ltd.

Osprey House, 1 Osprey Court
Hichingbrooke Business Park
Huntingdon, Cambridgeshire, PE29 6FN

Phone: +44 1480 411600
E-Mail: info@displaytechnology.co.uk
Internet: www.displaytechnology.co.uk

USA



Apollo Display Technologies, Corp.

87 Raynor Avenue,
Unit 1 Ronkonkoma,
NY 11779

Phone: +1 631 5804360
E-Mail: info@apolloDisplays.com
Internet: www.apolloDisplays.com